

# Ultra Fast Recovery Rectifiers UFR70, 71 & 72

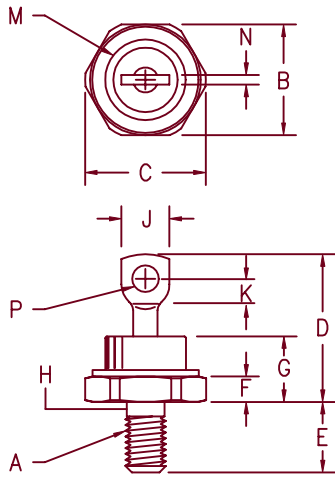

**Notes:**

1. 1/4-28
2. Full threads within 2 1/2 threads
3. For Reverse Polarity add R to Part Number  
Standard Polarity: Stud is Cathode  
Reverse Polarity: Stud is Anode

Dim.	Inches		Millimeter		Notes
	Minimum	Maximum	Minimum	Maximum	
A	---	---	---	---	1
B	.669	.688	16.99	17.48	
C	---	.793	---	20.14	
D	.750	1.00	19.05	25.40	
E	.422	.453	10.72	11.51	
F	.115	.200	2.92	5.08	
G	---	.450	---	11.43	
H	.220	.249	5.59	6.32	2
J	---	.375	---	9.53	
K	.156	---	3.97	---	
M	---	.667	---	16.94	Dia
N	---	.080	---	2.03	
P	.140	.175	3.56	4.45	Dia

## D0203AB (D05)

Microsemi Catalog Number	Working Peak Reverse Voltage	Peak Reverse Voltage
UFR7010*	100V	100V
UFR7015*	150V	150V
UFR7020*	UFR7120*	200V
	UFR7130*	300V
	UFR7140*	400V
UFR7250*	UFR7150*	500V
UFR7260*		600V
UFR7270*		700V
UFR7280*		800V

\*Add Suffix R For Reverse Polarity

- Ultra Fast Recovery Rectifier
- 175°C Junction Temperature
- $V_{RRM}$  100 to 800V
- High Reliability
- 70 Amps current rating
- $t_{RR}$  50 to 75 nsec maximum

Electrical Characteristics					
	UFR70	UFR71	UFR72		
Average forward current	$I_F(AV)$ 70A	70A	70A	Square wave, $R_{\theta JC} = 0.8^\circ C/W$	
Case Temperature	$T_C$ 125°C	110°C	105°C		
Maximum surge current	$I_{FSM}$ 1000A	800A	700A	8.3 ms, half sine, $T_J = 175^\circ C$	
Max peak forward voltage	$V_{FM}$ .975V	1.25V	1.35V	$I_{FM} = 70A: T_J = 25^\circ C^*$	
Max reverse recovery time	$t_{RR}$ 50 ns	60ns	75 ns	1/2A, 1A, 1/4A, $T_J = 25^\circ C$	
Max peak reverse current	$I_{RM}$ _____	3.0 mA	_____	$V_{RRM}, T_J = 125^\circ C$	
Max peak reverse current	$I_{RM}$ _____	25 $\mu A$	_____	$V_{RRM}, T_J = 25^\circ C$	
Typical Junction Capacitance	$C_J$ 300 pF	150 pF	150 pF	$V_R = 10V, f = 1MHz, T_J = 25^\circ C$	

\*Pulse test: Pulse width 300  $\mu sec$ , Duty cycle 2%

Thermal and Mechanical Characteristics		
Storage temp range	$T_{STG}$	-65°C to 175°C
Operating junction temp range	$T_J$	-65°C to 175°C
Max thermal resistance	$R_{\theta JC}$	0.8°C/W Junction to case
Typical thermal resistance	$R_{\theta CS}$	0.2°C/W Case to sink
Mounting torque		25-30 inch pounds
Weight		.54 ounces (15.3 grams) typical

# UFR70

Figure 1  
Typical Forward Characteristics

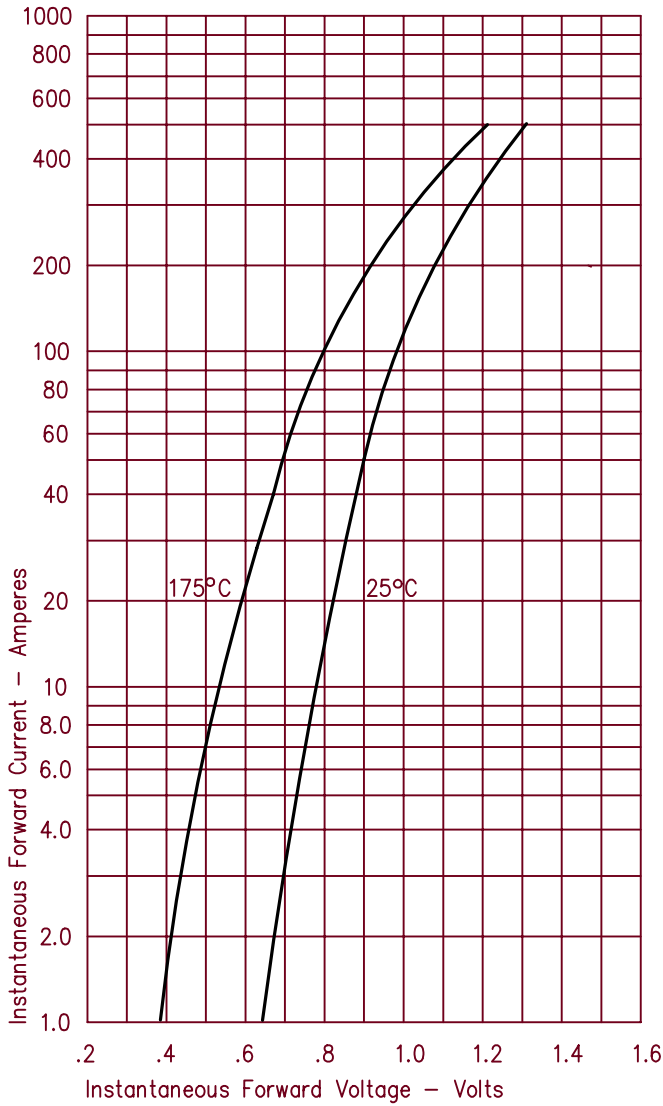

Figure 3  
Typical Junction Capacitance

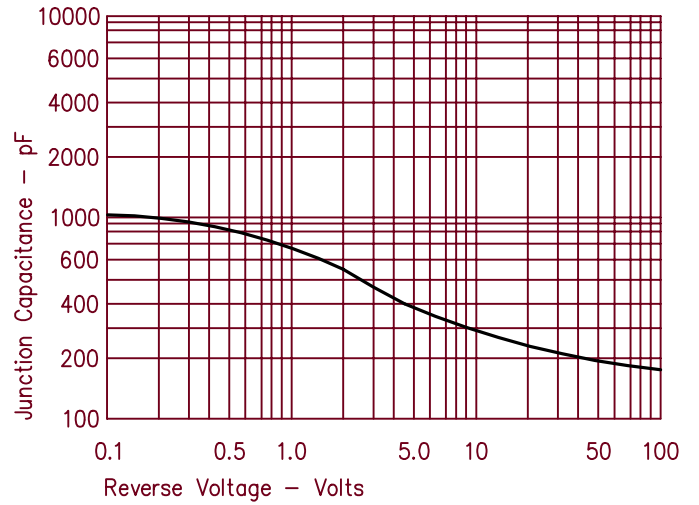

Figure 4  
Forward Current Derating

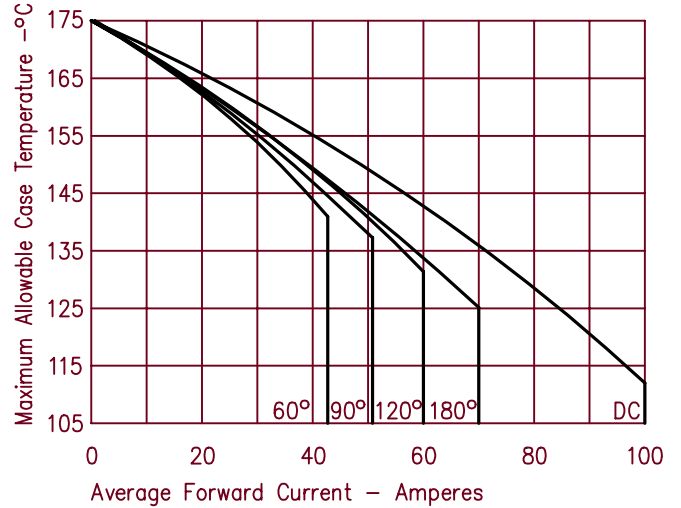

Figure 2  
Typical Reverse Characteristics

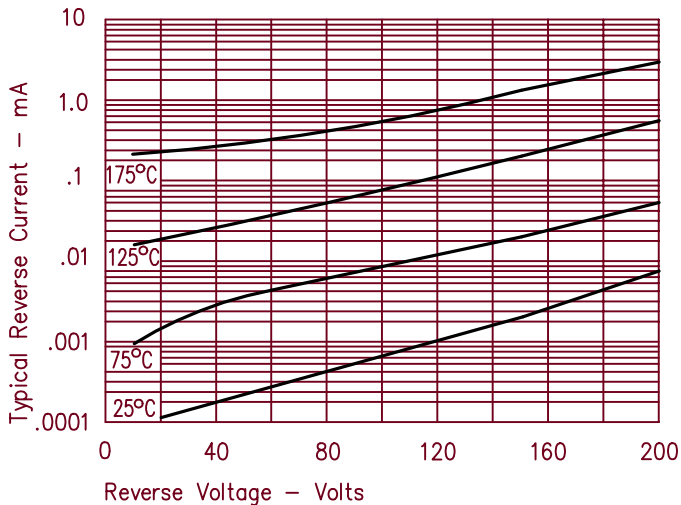
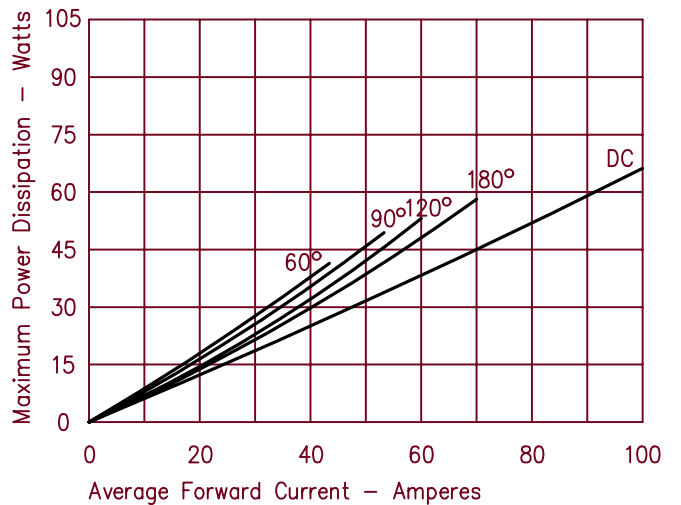

Figure 5  
Maximum Forward Power Dissipation



# UFR71

Figure 1  
Typical Forward Characteristics

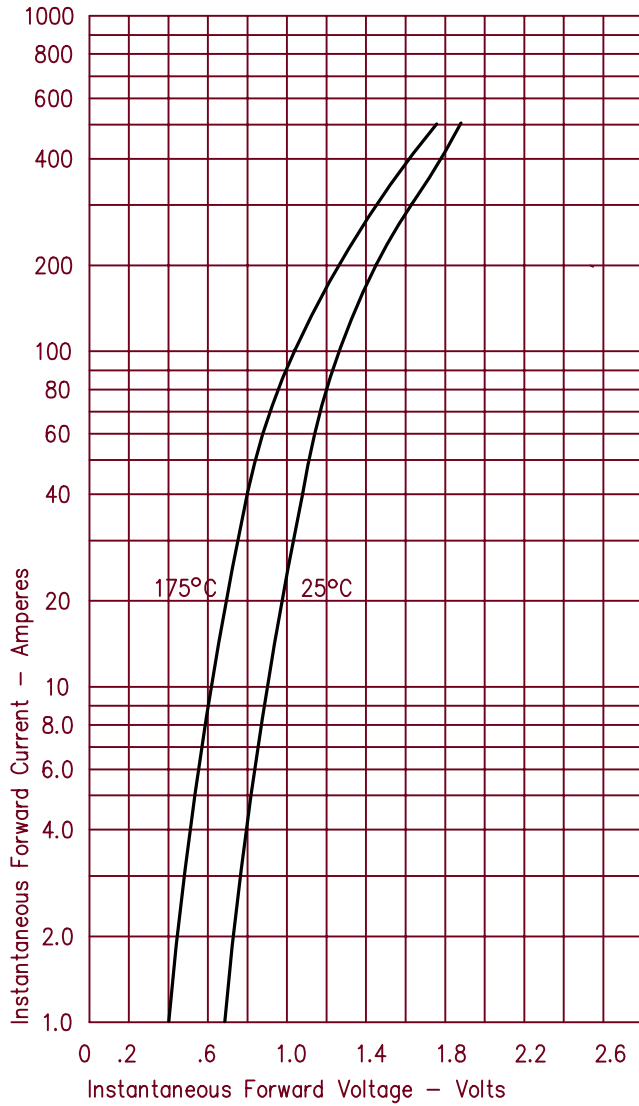

Figure 3  
Typical Junction Capacitance

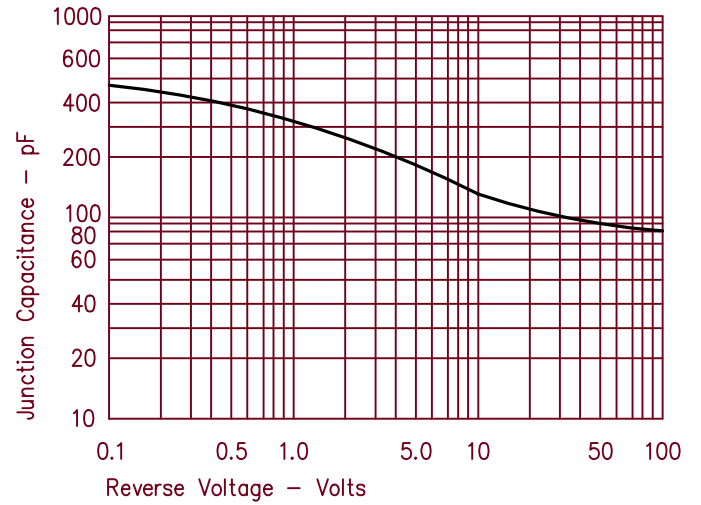

Figure 4  
Forward Current Derating

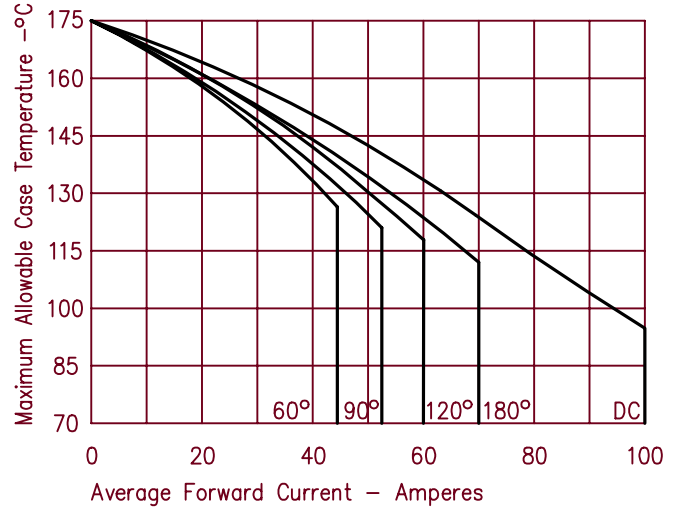

Figure 2  
Typical Reverse Characteristics

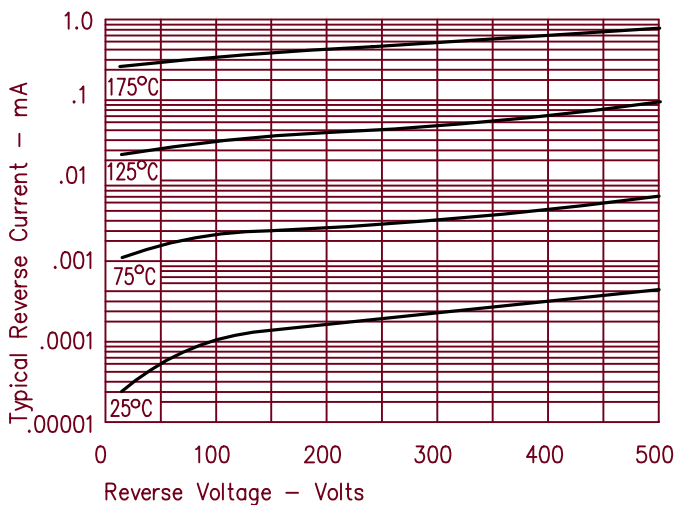
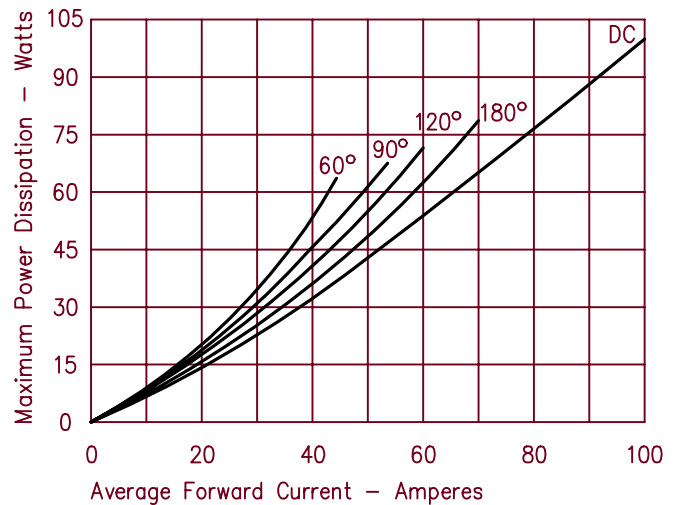

Figure 5  
Maximum Forward Power Dissipation



# UFR72

Figure 1  
Typical Forward Characteristics

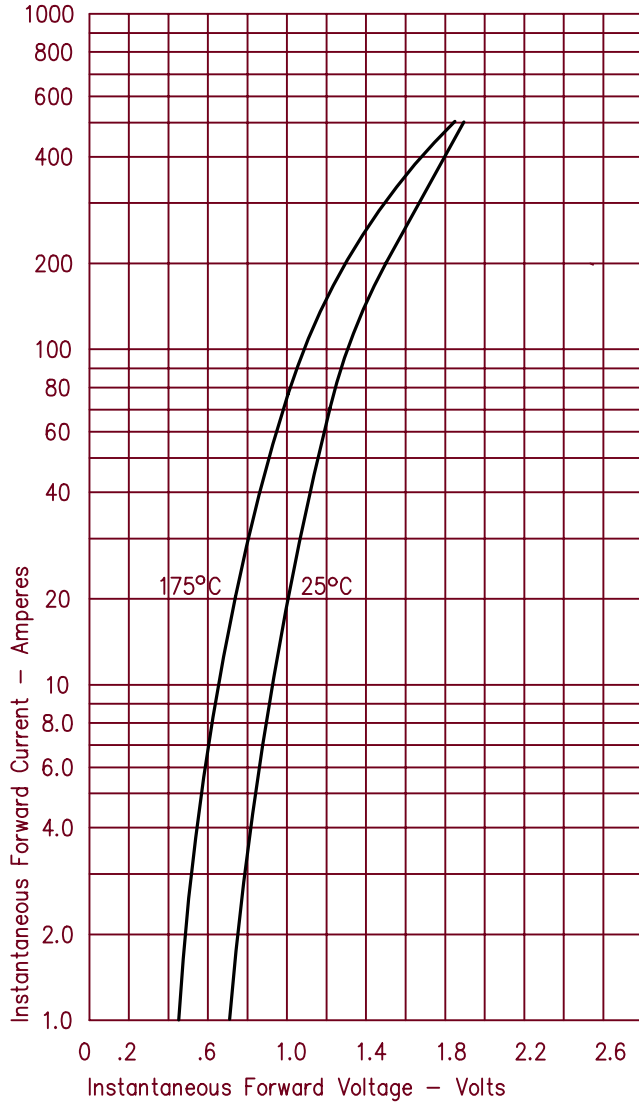

Figure 3  
Typical Junction Capacitance

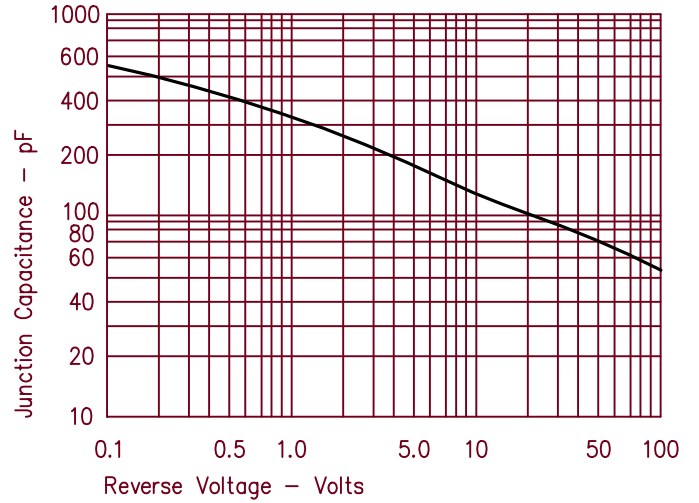

Figure 4  
Forward Current Derating

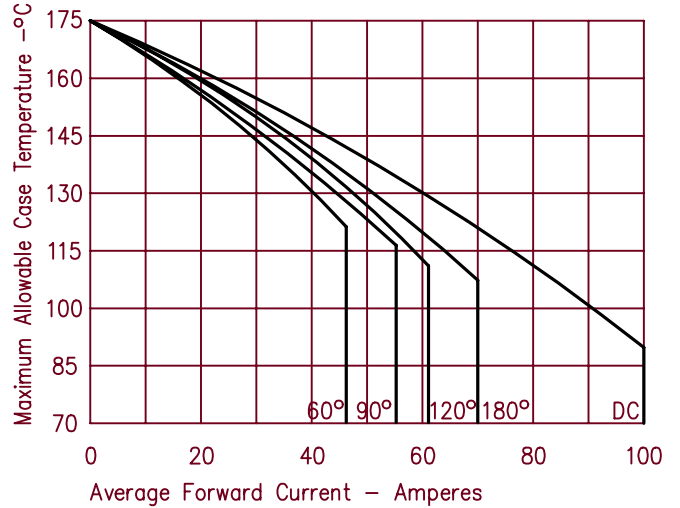

Figure 2  
Typical Reverse Characteristics

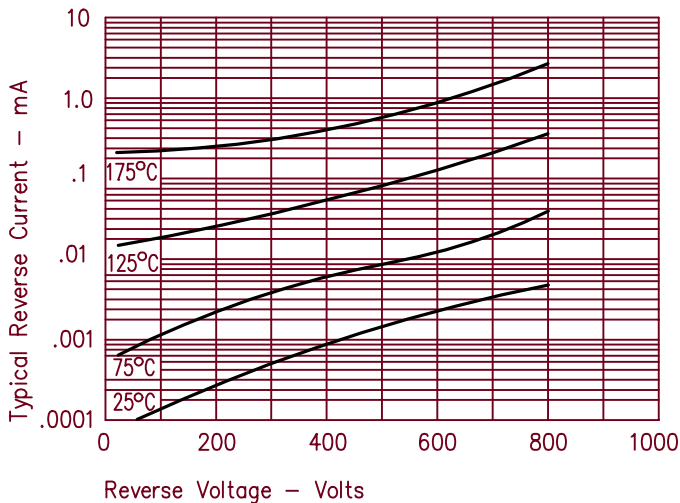

Figure 5  
Maximum Forward Power Dissipation

