

CE marked for Low Voltage Directive

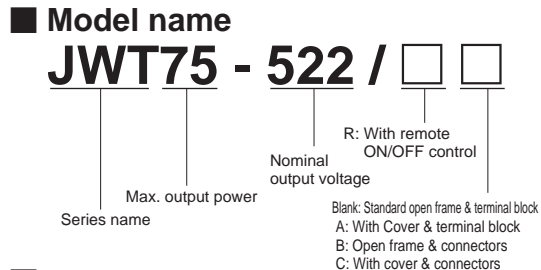

- Features**
- CE marking
Meet to Low Voltage Directive: Approved by EN60950
 - Machinery Directive (Approved by VDE0160)
 - Power Factor & Harmonic Correction (Built to meet EN61000-3-2)
 - Universal Input (85 ~ 265VAC)
 - EMI (Built to meet EN55011-B, EN55022-B, VCCI-B, FCC-B)
 - Remote ON/OFF control (Optional model)

Specifications

1. Input voltage range	85 ~ 265VAC (47 ~ 63Hz) Universal input
2. Power Factor	0.99 (typ) at 100VAC Full load, 0.93 (typ) at 200VAC Full load
3. Cooling	Convection cooling
4. Operating Temperature	Open frame type: -10 ~ +65°C (-10 ~ +50°C: 100%, +65°C: 50%) JWT75 with cover type: -10 ~ +55°C (-10 ~ +45°C: 100%, +55°C: 60%) JWT100 with cover type: -10 ~ +50°C (-10 ~ +40°C: 100%, +50°C: 60%)
5. Withstand voltage	Input to output: 3kVAC (20mA) for 1 min., Input to FG: 2kVAC (20mA) for 1 min. Output to FG: 500VAC (100mA) for 1 min.
6. Conducted emission noise	Built to meet EN55011-B, EN55022-B, FCC class B, VCC I class B
7. Radiated emission noise	Built to meet EN55011-B, EN55022-B, FCC class B, VCC I class B
8. PFHC	Built to meet EN61000-3-2
9. Safety standard	Approved to UL1950 , CSA950(C-UL) , EN60950 (TUV) and VDE0160(TUV)
10. Functions	OVP (V1 only), OCP
11. Option	Remote ON/OFF control, Cover, Input & output connector terminals

Line-up

Model		Output Channel	Output Voltage	Output Current	Output Power/ch	Total output Power	Safety Standard		
							EN60950	UL1950	CSA950
JWT75	JWT75-522	CH1(V1)	5V	0.8 ~ 8.0A	40W	75W	○	○	○
		CH2(V2)	+12V	0 ~ 4.0A	48W				
		CH3(V3)	-12V	0 ~ 0.5A	6W				
	JWT75-5FF	CH1(V1)	5V	0.8 ~ 8.0A	40W	75W	○	○	○
		CH2(V2)	+15V	0 ~ 3.2A	48W				
		CH3(V3)	-15V	0 ~ 0.5A	7.5W				
	JWT75-525	CH1(V1)	5V	0.8 ~ 8.0A	40W	75W	○	○	○
		CH2(V2)	+12V	0 ~ 4.0A	48W				
		CH3(V3)	-5V	0 ~ 0.5A	2.5W				
JWT100	JWT100-522	CH1(V1)	5V	1.3 ~ 13.0A	65W	100W	○	○	○
		CH2(V2)	+12V	0 ~ 5.5A	66W				
		CH3(V3)	-12V	0 ~ 1.0A	12W				
	JWT100-5FF	CH1(V1)	5V	1.3 ~ 13.0A	65W	100W	○	○	○
		CH2(V2)	+15V	0 ~ 4.5A	67.5W				
		CH3(V3)	-15V	0 ~ 1.0A	15W				
	JWT100-525	CH1(V1)	5V	1.3 ~ 13.0A	65W	100W	○	○	○
		CH2(V2)	+12V	0 ~ 5.5A	66W				
		CH3(V3)	-5V	0 ~ 1.0A	5W				

*Preload required 0.8A(ch1) on JWT75, 1.3A(ch1) on JWT100.

○ : Safety standard approved

Outline drawing

JWT75

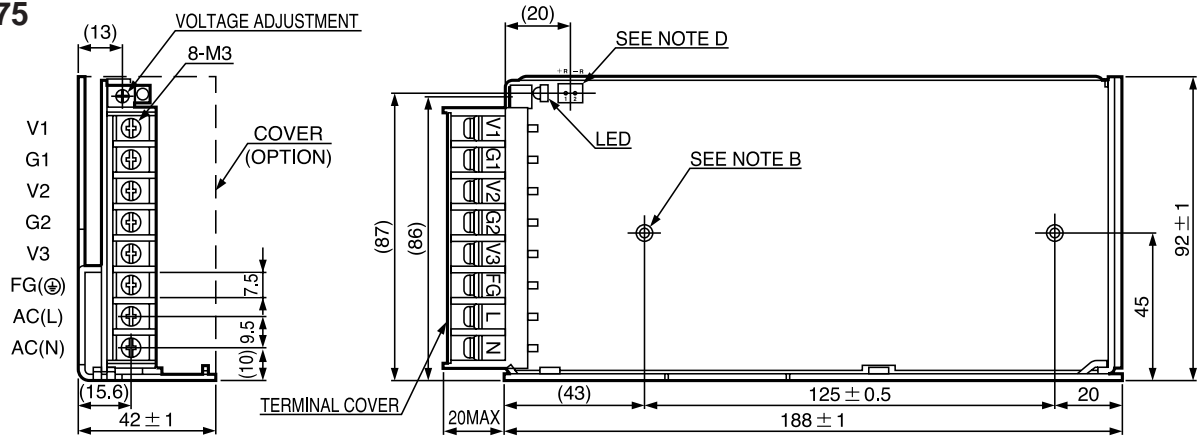

NOTES

- A: MODEL NAME, OPTION, INPUT VOLTAGE RANGE, NOMINAL OUTPUT VOLTAGE, MAXIMUM OUTPUT CURRENT AND COUNTRY OF MANUFACTURE ARE SHOWN HERE IN ACCORDANCE WITH THE SPECIFICATIONS.
- B: M4 EMBOSSED, TAPPED AND COUNTERSUNK HOLES (4) FOR CUSTOMER CHASSIS MOUNTING. SCREWS MUST NOT PROTRUDE INTO POWER SUPPLY BY MORE THAN 6mm.
- C: $\phi 4.5$ HOLE FOR CUSTOMER CHASSIS MOUNTING. (USE M4 MOUNTING SCREW.)
- D: REMOTE ON/OFF CONTROL CONNECTOR -- OPTION B2B-XH-AM (JST)

ACCESSORIES

- * COVER FOR BARRIER STRIP TERMINAL
- * HOUSING: XHP-2 (JST), TERMINAL: BXH-001T-P0.6 (JST) OR SXH-001T-P0.6 (JST) -- OPTION

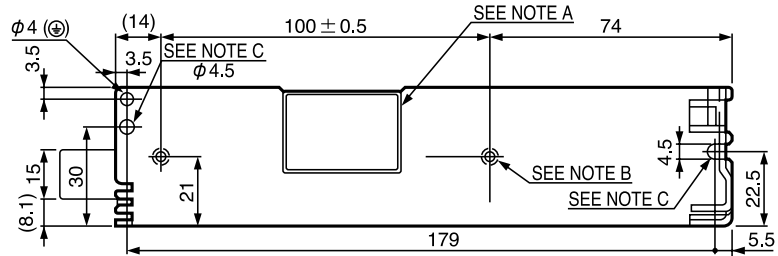

(Unit: mm)

JWT75 (Connector terminal type)

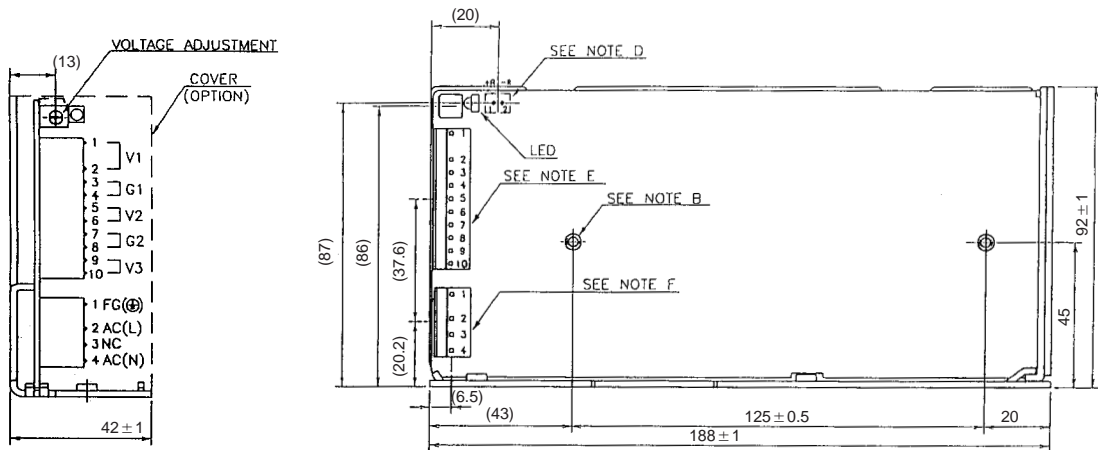

NOTES

- A: MODEL NAME, OPTION, INPUT VOLTAGE RANGE, NOMINAL OUTPUT VOLTAGE, MAXIMUM OUTPUT CURRENT AND COUNTRY OF MANUFACTURE ARE SHOWN HERE IN ACCORDANCE WITH THE SPECIFICATIONS.
- B: M4 EMBOSSED, TAPPED AND COUNTERSUNK HOLES (4) FOR CUSTOMER CHASSIS MOUNTING. SCREWS MUST NOT PROTRUDE INTO POWER SUPPLY BY MORE THAN 6mm.
- C: $\phi 4.5$ HOLE FOR CUSTOMER CHASSIS MOUNTING. (USE M4 MOUNTING SCREW.)
- D: REMOTE ON/OFF CONTROL CONNECTOR -- OPTION B2B-XH-AM (JST)
- E: CONNECTOR: 5277-10A (MOLEX)
- F: CONNECTOR: 5289-4A (MOLEX)

ACCESSORIES

- HOUSING: 5196-10 (MOLEX), TERMINAL: 5194PBT (MOLEX)
- HOUSING: 5199-04 (MOLEX), TERMINAL: 5194PBT (MOLEX)
- HOUSING: XHP-2 (JST), TERMINAL: BXH-001T-P0.6 (JST) OR SXH-001T-P0.6 (JST) -- OPTION

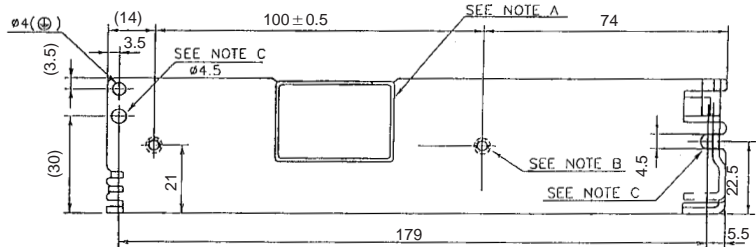

Recommended Noise Filter

MAW-1202-22



GO!!

P134

Recommended Power Supply Fixture

GO!!



P198

(Unit: mm)

JWT100

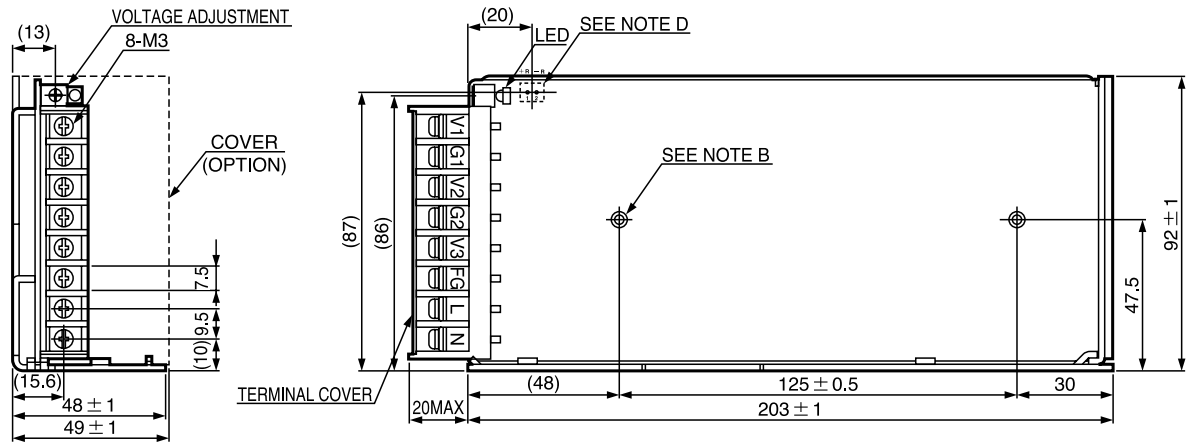

NOTES

- A: MODEL NAME, OPTION, INPUT VOLTAGE RANGE, NOMINAL OUTPUT VOLTAGE, MAXIMUM OUTPUT CURRENT AND COUNTRY OF MANUFACTURE ARE SHOWN HERE IN ACCORDANCE WITH THE SPECIFICATIONS.
 - B: M4 EMBOSSED, TAPPED AND COUNTERSUNK HOLES (5) FOR CUSTOMER CHASSIS MOUNTING. SCREWS MUST NOT PROTRUDE INTO POWER SUPPLY BY MORE THAN 6mm.
 - C: $\phi 4.5$ HOLE FOR CUSTOMER CHASSIS MOUNTING. (USE M4 MOUNTING SCREW.)
 - D: REMOTE ON/OFF CONTROL CONNECTOR -- OPTION B2B-XH-A (JST)
- ACCESSORIES**
- * COVER FOR BARRIER STRIP TERMINAL
 - * HOUSING: XHP-2 (JST), TERMINAL: BXH-001T-P0.6 (JST) OR SXH-001T-P0.6 (JST) -- OPTION

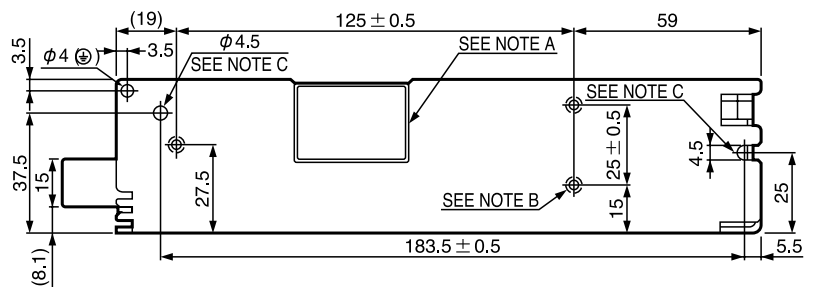

(Unit: mm)

JWT100 (Connector terminal type)

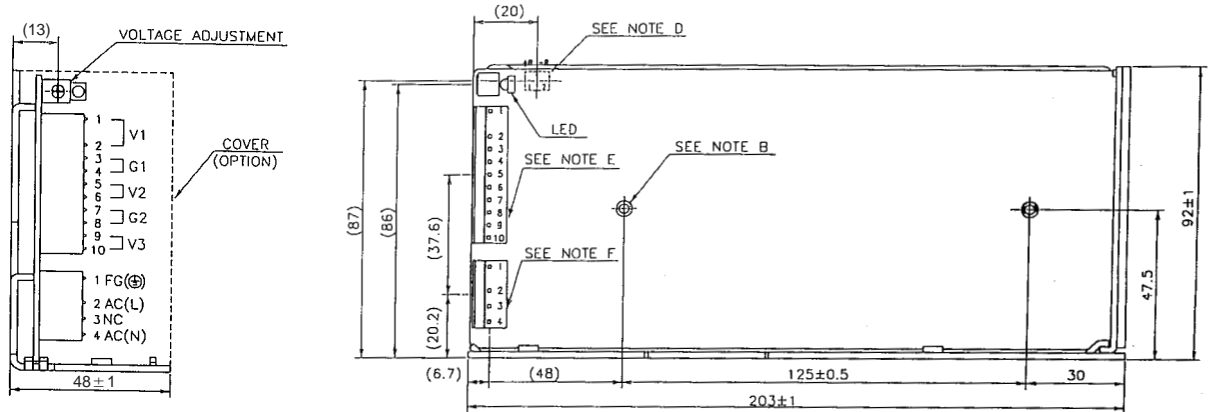

NOTES

- A: MODEL NAME, OPTION, INPUT VOLTAGE RANGE, NOMINAL OUTPUT VOLTAGE, MAXIMUM OUTPUT CURRENT AND COUNTRY OF MANUFACTURE ARE SHOWN HERE IN ACCORDANCE WITH THE SPECIFICATIONS.
- B: M4 EMBOSSED, TAPPED AND COUNTERSUNK HOLES (5) FOR CUSTOMER CHASSIS MOUNTING. SCREWS MUST NOT PROTRUDE INTO POWER SUPPLY BY MORE THAN 6mm.
- C: $\phi 4.5$ HOLE FOR CUSTOMER CHASSIS MOUNTING. (USE M4 MOUNTING SCREW.)
- D: REMOTE ON/OFF CONTROL CONNECTOR -- OPTION B2B-XH-AM (JST)
- E: CONNECTOR: 5277-10A (MOLEX)
- F: CONNECTOR: 5289-4A (MOLEX)

ACCESSORIES

- * HOUSING: 5196-10 (MOLEX), TERMINAL: 5194PBT (MOLEX)
- * HOUSING: 5199-04 (MOLEX), TERMINAL: 5194PBT (MOLEX)
- * HOUSING: XHP-2 (JST), TERMINAL: BXH-001T-P0.6 (JST) OR SXH-001T-P0.6 (JST) -- OPTION

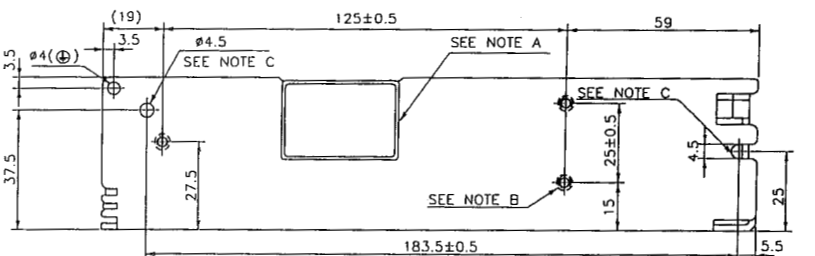

(Unit: mm)

● Recommended Noise Filter
MAW-1202-22

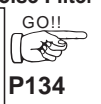

● Recommended Power Supply Fixture
P198