

Features

- 40 mA OUTPUT SINK CAPABILITY
- BLANKING CAPABILITY PROVIDED
- LAMP TEST INPUT
- PIN AND FUNCTION EQUIVALENT OF TTL 7447A

General Description

This device is characterized by seven open-collector outputs corresponding to the segments in LED display units such as the Monsanto Man-1. A 4-bit binary code applied to the data inputs causes the outputs to turn on in the conventional 7 segment code.

A blanking input is provided that turns all of the outputs off whenever it is low (regardless of the state of any other inputs). Also provided is a lamp test input that can be operated whenever the blanking input is high. A logical zero on the lamp test

input will turn all seven outputs on. A ripple-blanking input is provided that has no effect except when each of the four data inputs are at logic zero. Then if the ripple-blanking input is at zero, when (and only when) the four data inputs are at zero, all seven outputs will be at logic one (display off). If the ripple-blanking input is at logic one (and the four data inputs are at zero), all outputs except O_G will be at zero ("0" displayed). If any of the data inputs are at logic one, the ripple-blanking input will have no effect.

One pin brought out from the internal logic of the device can be used as either an input or an output. If the blanking input/ripple-blanking output is tied low (treating the pin as an input), all seven outputs will be at logic one. If the lamp test input is at one and the ripple-blanking input and the four data inputs are at zero, the ripple-blanking output will be at zero and the seven other outputs will be high.

Logic Diagram

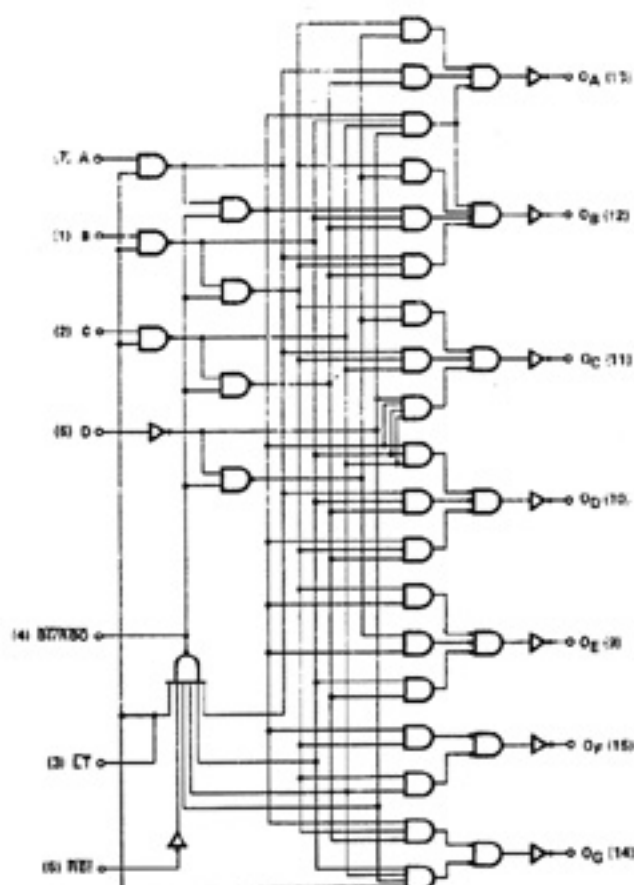

Equivalent Circuits

TYPICAL INPUT

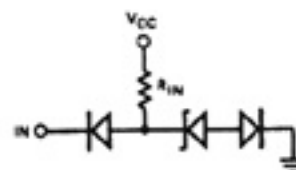

TYPICAL OUTPUT

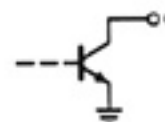

Truth Table

DECIMAL OR FUNCTION	INPUTS						OUTPUTS							
	\overline{LT}	\overline{RB}	D	C	B	A	\overline{RBO}	O_A	O_B	O_C	O_D	O_E	O_F	O_G
0	1	1	0	0	0	0	1	0	0	0	0	0	0	1
1	1	X	0	0	0	1	1	1	1	1	1	0	0	1
2	1	X	0	0	1	0	1	0	0	1	0	0	1	0
3	1	X	0	0	1	1	1	0	0	0	0	1	1	0
4	1	X	0	1	0	0	1	1	0	0	1	1	0	0
5	1	X	0	1	0	1	1	0	1	0	0	1	0	0
6	1	X	0	1	1	0	1	1	1	0	0	0	0	1
7	1	X	0	1	1	1	1	0	0	0	1	1	1	0
8	1	X	1	0	0	0	0	0	0	0	0	0	0	0
9	1	X	1	0	0	1	1	0	0	0	1	0	0	0
10	1	X	1	0	1	0	1	1	1	1	0	1	1	0
11	1	X	1	0	1	1	1	1	1	1	0	1	1	0
12	1	X	1	1	0	0	1	1	0	0	1	1	0	0
13	1	X	1	1	0	1	1	0	1	0	0	1	0	0
14	1	X	1	1	1	0	1	1	1	1	0	1	0	1
15	1	X	1	1	1	1	1	1	1	1	1	1	1	1
\overline{BI}	X	X	X	X	X	X	0	1	1	1	1	1	1	1
\overline{RBI}	1	0	0	0	0	0	0	1	1	1	1	1	1	1
\overline{LT}	0	X	X	X	X	X	1	0	0	0	0	0	0	0

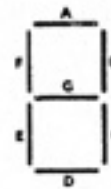

SEGMENT IDENTIFICATION



Loading Table

PINS	FUNCTION	LOADING
A, B, C, D	Inputs	1 UL
\overline{RBI}	Ripple-Blanking Input	1 UL
\overline{LT}	Lamp Test	3 UL
\overline{BI}	Blanking Input	2 UL
O_A -G	Outputs	See Electrical Characteristics
RBO	Ripple-Blanking Output	2 UL

See page 20 for general electrical characteristics.

Typical Performance Characteristics

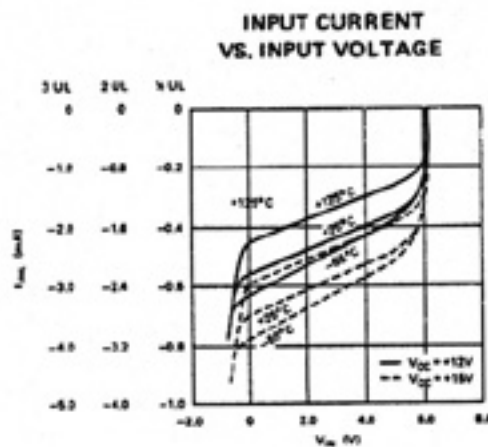

OUTPUT CURRENT VS. OUTPUT VOLTAGE OUTPUT LOW

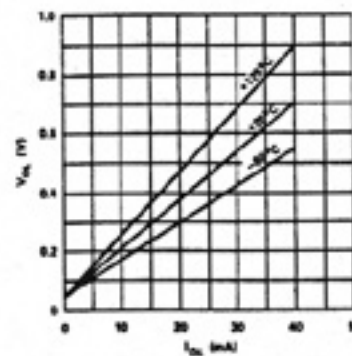

Typical Applications

This device is characterized by seven open-collector outputs corresponding to the segments in LED display units such as the Monsanto Man-1. A 4-bit binary code applied to the data inputs causes the outputs to turn on in the conventional 7-segment code.

CURRENT LIMITING RESISTORS

LED displays require that the current through them be limited by series resistors. The maximum current flow may be determined by either the LED display or the 383. Since the 383 is specified for 20 mA max. continuous duty (40 mA max. 50% duty cycle), displays that require their current to be held to 20 mA or less should have their resistor values calculated on the basis of the max. display current. Displays that must be limited to currents greater than 20 mA should have their resistor values calculated on the basis of the 20 mA max. current of the 383 (strobed applications will be considered separately).

Sample calculation — Monsanto MAN-1 has a 20 mA max. forward current and a voltage drop per segment of 3.4V typ.

$$R_{LIM} = \frac{V_{CC} - V_F - V_{OL}}{I_F} = \frac{13.0V - 3.4V - 0.7V}{20 \text{ mA}} = 445\Omega \quad (\text{Fig. 1})$$

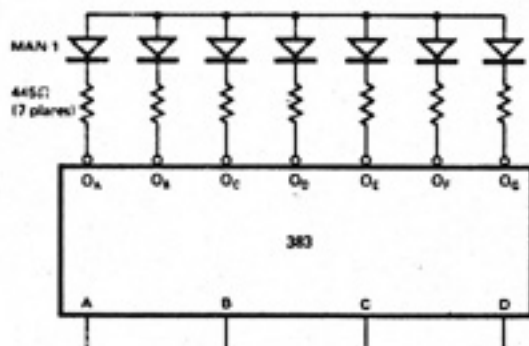
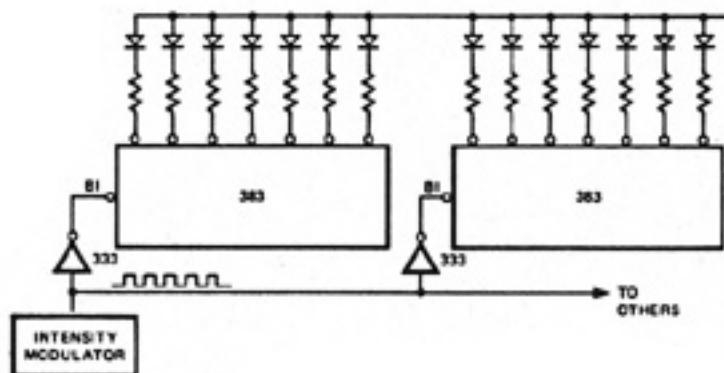

Figure 1.



STROBING OPERATION

One popular technique for increasing the apparent brightness of displays is to pulse the displays with high currents and "average down" the power dissipation by lowering the duty cycle accordingly. The display manufacturers should be consulted as to the max. current vs. duty cycle that should be used with their units. The 383 should not be used with a display current of more than 40 mA NO MATTER WHAT THE DUTY CYCLE! Failure to observe this precaution can cause permanent damage to the device. In addition, the 40 mA figure should not be used unless the duty cycle is 50% or less. Limiting resistor values should be calculated on the basis of the strobed current.

Sample Calculation — Assume the MAN-1 display is to be run at the max. current allowed by the 383 — 40 mA @ 50% duty cycle.

$$R_{LIM} = \frac{V_{CC} - V_F - V_{OL}}{I_{STROBE}} = \frac{13.0V - 3.6V - 1.2V}{40 \text{ mA}} = 205\Omega$$

The strobing operation itself is accomplished by use of the Blanking Input (Figure 2).

A suggested circuit for an intensity modulator is shown in Figure 3.

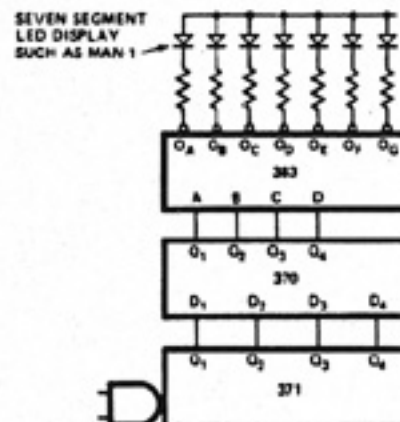

This application demonstrates the use of the 383 to drive seven-segment displays such as the man-1. Since each output of the 383 will sink 20 mA, the display can be driven directly without external components other than current limiting resistors. Also illustrated is the 370 quad latch and 371 decade counter being used to acquire and store the number to be displayed.

Figure 3. Intensity Modulator Circuit — Output duty cycle varies from 0% — 100% depending on switch setting.

Typical Applications (contd.)

RIPPLE BLANKING

Provision has been made on the 383 for blanking out insignificant zeroes to increase legibility. Thus 007.50500 would be displayed at 7.505 if the ripple-blanking provisions were used. If the RBI pin is tied low, the display will be blanked every time a BCD zero is applied to the data inputs. This is normally done for the first and last digits of a display. In the previous example, 007.50500 would be displayed at 07.5050, the first and last digits being blanked since they are zero.

This scheme cannot be applied directly to all of the digits since it would cause 007.50500 to be displayed at 7.5_5. This problem is eliminated by the RBO output pin which delivers a logic zero whenever a BCD zero is on the data inputs. By feeding this information to the RBI inputs of the next 383, blanking will be accomplished only on nonsignificant zeroes. The RBO pin must be used with an 8.2k discrete pullup resistor.

