

**Features**

- Avalanche rugged technology.
- Low input capacitance.
- Improved gate charge.
- Low leakage current : 10uA (Max.) @  $V_{DS}=500V$ .
- Low  $R_{DS(ON)}$  : 1.17 $\Omega$  (Typ.)

**Ordering Information**

Type NO.	Marking	Package Code
STK830F	STK830	TO-220F

**Outline Dimensions**

unit : mm

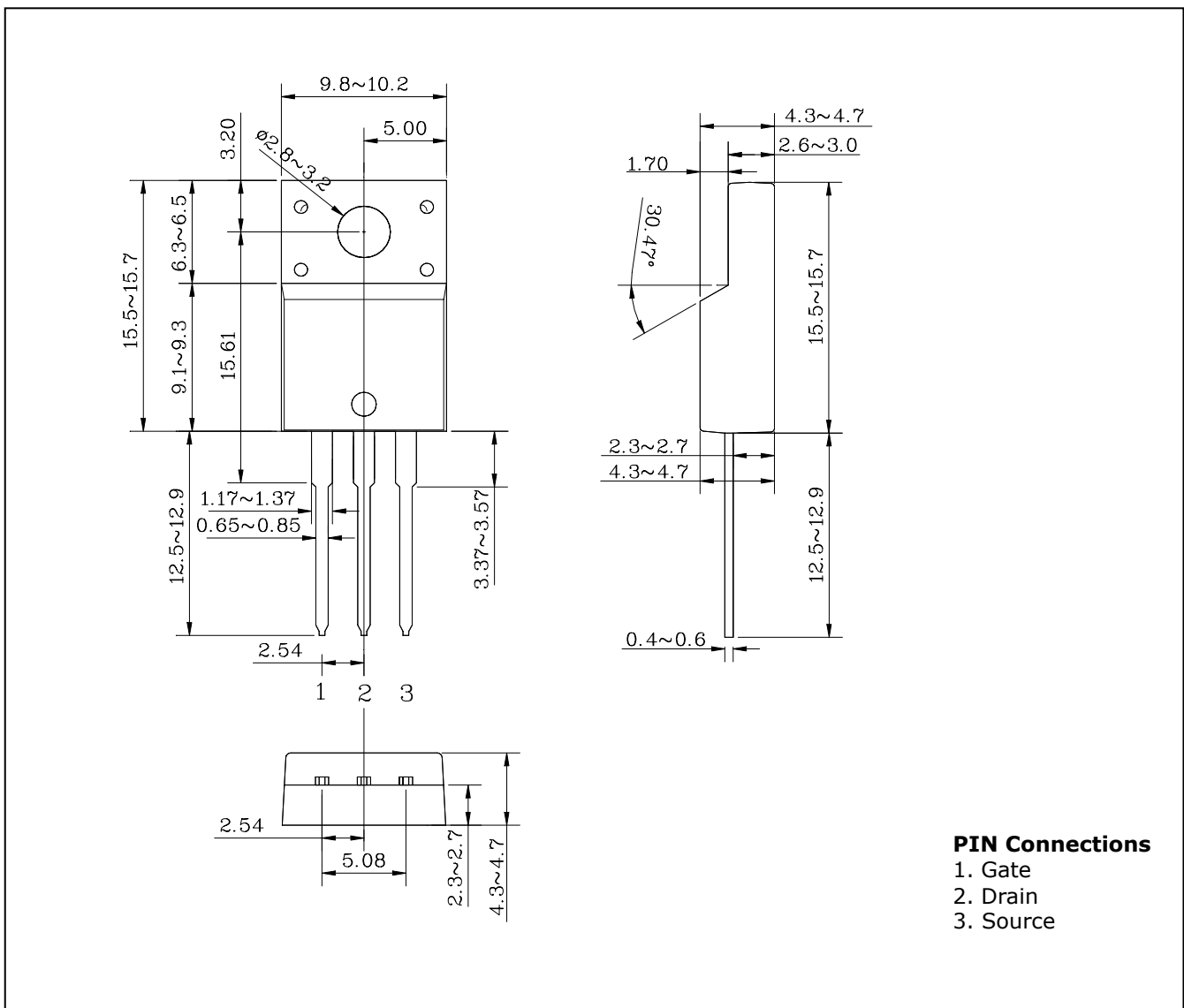

## Absolute maximum ratings

Characteristic	Symbol	Rating	Unit
Drain-Source voltage	$V_{DSS}$	500	V
Gate-Source voltage	$V_{GS}$	$\pm 30$	V
Continuous Drain current ( $T_c=25^\circ\text{C}$ )	$I_D$	4.5*	A
Continuous Drain current ( $T_c=100^\circ\text{C}$ )	$I_D$	2.9*	A
Drain Current-Pulsed ①	$I_{DM}$	18	A
Power Dissipation ( $T_c=25^\circ\text{C}$ )	$P_D$	38	W
Linear Derating Factor		0.3	W/ $^\circ\text{C}$
Single Pulsed Avalanche Energy ②	$E_{AS}$	270	mJ
Avalanche current ①	$I_{AR}$	4.5	A
Repetitive Avalanche Energy ①	$E_{AR}$	7.3	mJ
Peak Diode Recovery dv/dt	dv/dt	5.5	V/ns
Operating Junction and Storage temperature range	$T_J, T_{stg}$	-55~150	$^\circ\text{C}$
Maximum lead temp. for soldering Purpose, 1/8" from case for 5-seconds	$T_L$	300	$^\circ\text{C}$

\* Limited by Maximum junction Temperature

## Thermal Resistance

Characteristic	Symbol	Typ.	Max	Units
Junction-to-Case	$R_{\theta JC}$		3.31	$^\circ\text{C}/\text{W}$
Case-to-Sink	$R_{\theta CS}$	0.5		
Junction-to-Ambient	$R_{\theta JA}$		62.5	

## Electrical Characteristics (Tc=25°C unless otherwise specified)

Characteristic	Symbol	Test Condition	Min.	Typ.	Max.	Unit
Drain-Source breakdown voltage	$BV_{DSS}$	$I_D=250\mu A, V_{GS}=0$	500			V
Gate-Threshold voltage	$V_{GS(th)}$	$I_D=250\mu A, V_{DS}=5V$	2.0		4.0	V
Drain-source leakage current	$I_{DSS}$	$V_{DS}=500V$			10	$\mu A$
Gate-source leakage	$I_{GSS}$	$V_{DS}=0V, V_{GS}=\pm 30V$			$\pm 100$	nA
Drain-Source on-resistance ④	$R_{DS(on)}$	$V_{GS}=10V, I_D=2.25A$			1.5	$\Omega$
Forward transconductance ④	$g_{fs}$	$V_{DS}=50V, I_D=2.25A$		3.87		S
Input capacitance	$C_{iss}$	$V_{GS}=0V, V_{DS}=25V, f=1MHz$		760	900	pF
Output capacitance	$C_{oss}$			85	100	
Reverse transfer capacitance	$C_{rss}$			15	22	
Turn-on delay time	$t_{d(on)}$	$V_{DD}=250V, I_D=4.5A$ $R_G=12\Omega$ ④⑤		15	40	ns
Rise time	$t_r$			16	40	
Turn-off delay time	$t_{d(off)}$			66	140	
Fall time	$t_f$			22	55	
Total gate charge	$Q_g$	$V_{DS}=400V, V_{GS}=10V,$ $I_D=4.5A$ ④⑤		33	43	nC
Gate-source charge	$Q_{gs}$			4.4		
Gate-drain("Miller")charge	$Q_{gd}$			16.6		

## Source-Drain Diode Ratings and Characteristics

Characteristic	Symbol	Test Condition	Min	Typ	Max	Units
Continuous source current	$I_S$	Integral reverse pn-diode in the MOSFET			4.5	A
Pulsed-source current ①	$I_{SM}$				18	
Diode forward voltage ④	$V_{SD}$	$T_J=25^\circ C, V_{GS}=0V, I_S=4.5A$			1.4	V
Reverse recovery time	$t_{rr}$	$T_J=25^\circ C, I_F=4.5A$ $di_F/dt=100A/us$ ④		285		ns
Reverse recovery charge	$Q_{rr}$			2.0		$\mu C$

Note ;

- ① Repetitive Rating : Pulse Width Limited by Maximum Junction Temperature
- ②  $L=30mH, I_{AS}=4.5A, V_{DD}=50V, R_G=27\Omega$  , starting  $T_J=25^\circ C$
- ③  $I_{SD} \leq 4.5A, di/dt \leq 130A/us, V_{DD} \leq BV_{DSS}$ , starting  $T_J=25^\circ C$
- ④ Pulse Test : Pulse Width=250us, Duty cycle $\leq 2\%$
- ⑤ Essentially independent of operating temperature

Electrical Characteristic Curves

Fig. 1  $I_D - V_{DS}$

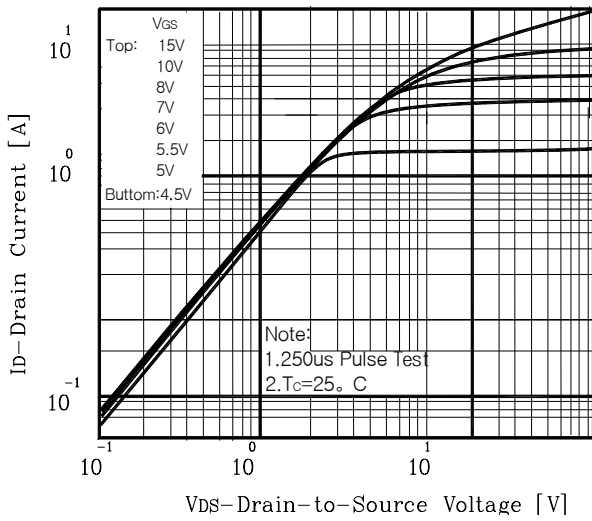

Fig. 2  $I_D - V_{GS}$

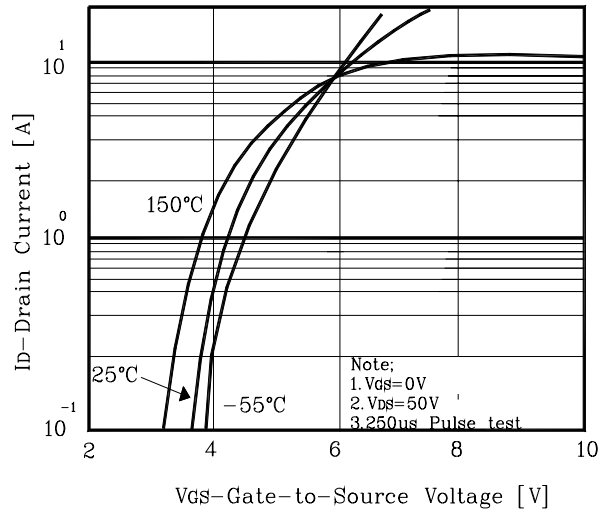

Fig. 3  $R_{DS(on)} - I_D$

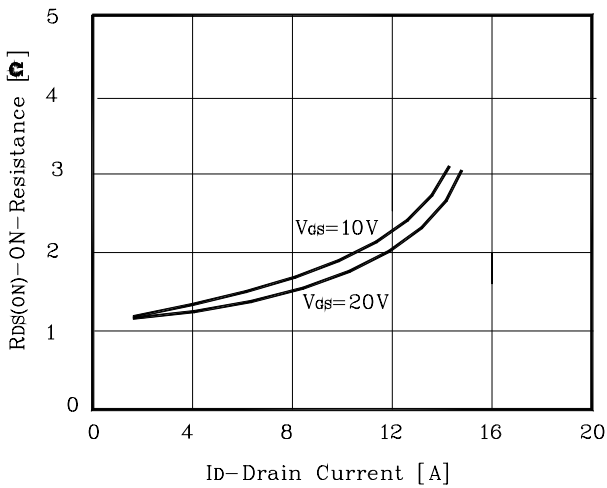

Fig. 4  $I_{DR} - V_{SD}$

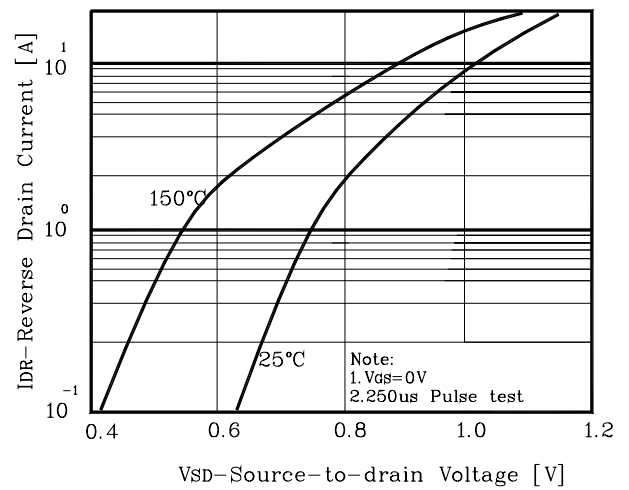

Fig. 5 Capacitance -  $V_{DS}$

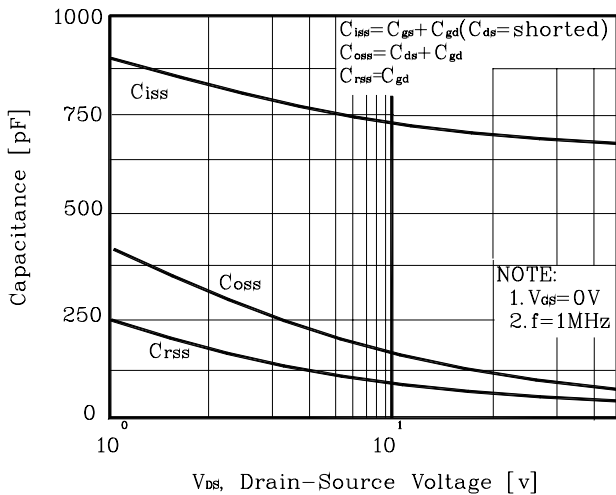
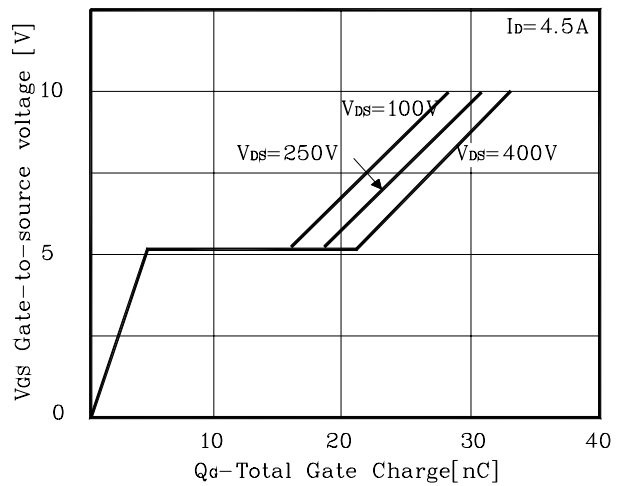
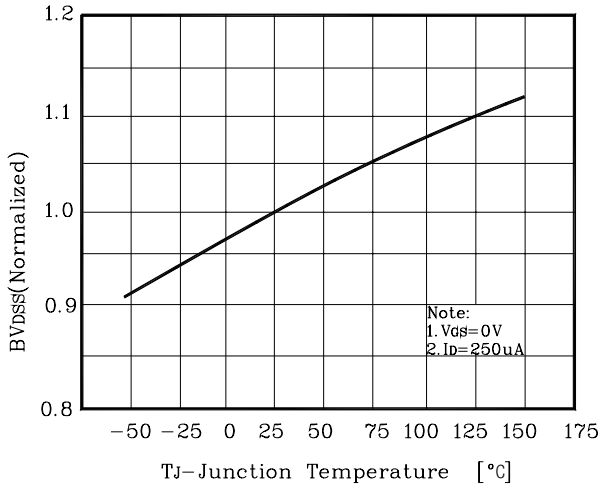

Fig. 6  $V_{GS} - Q_G$



**Fig. 7  $BV_{DSS} - T_J$**



**Fig. 8  $R_{DS(on)} - T_J$**

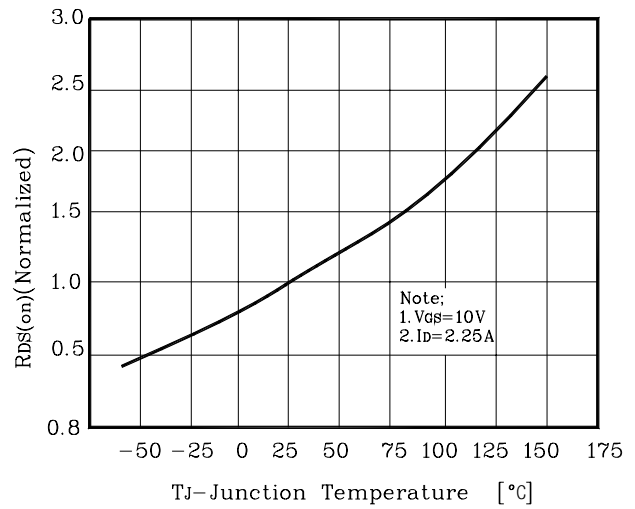

**Fig. 9  $I_D - T_C$**

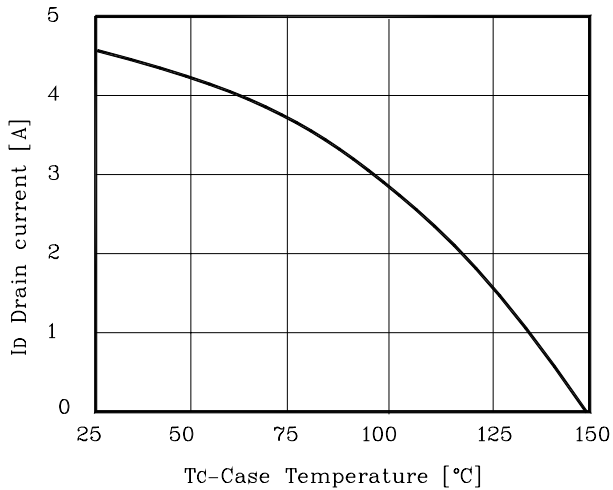

**Fig. 10 Safe operating Area**

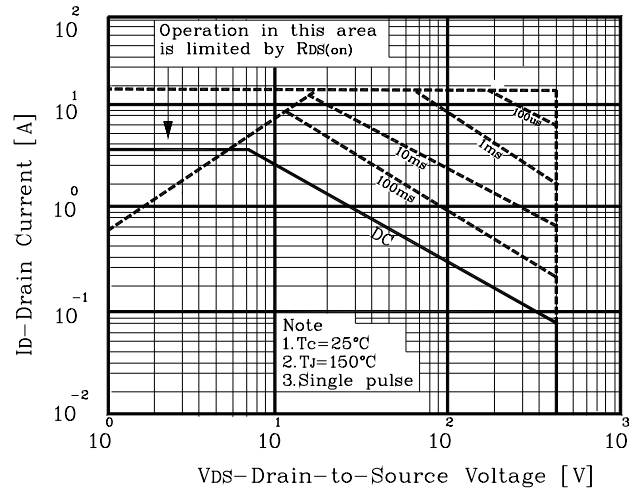

**Fig. 11 Thermal Response**

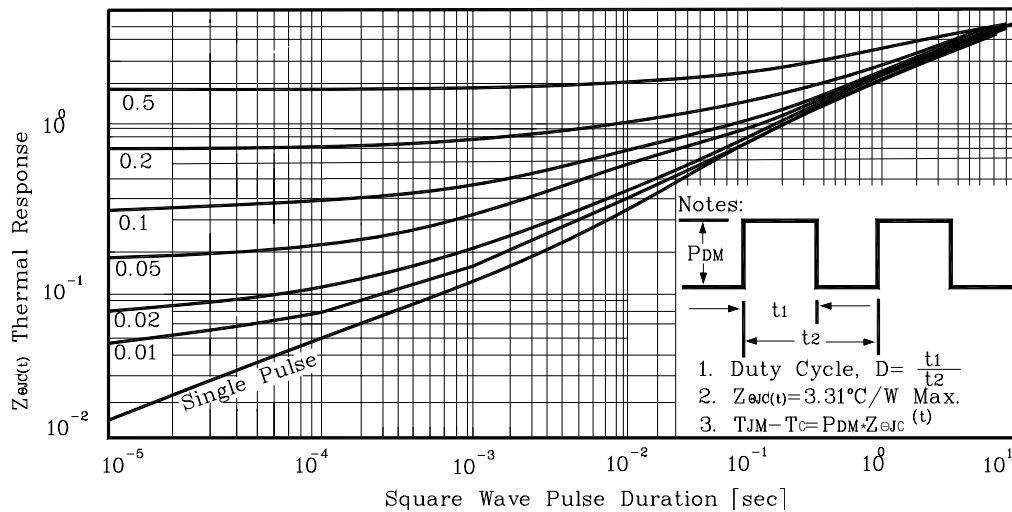

Fig. 12 Gate Charge Test Circuit & Waveform

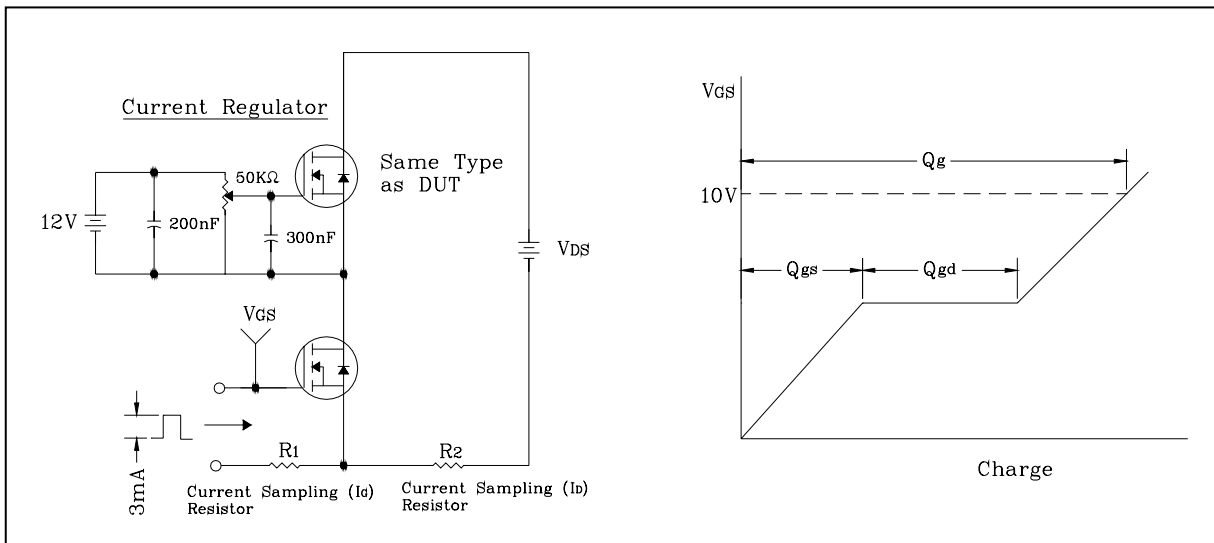

Fig. 13 Resistive Switching Test Circuit & Waveform

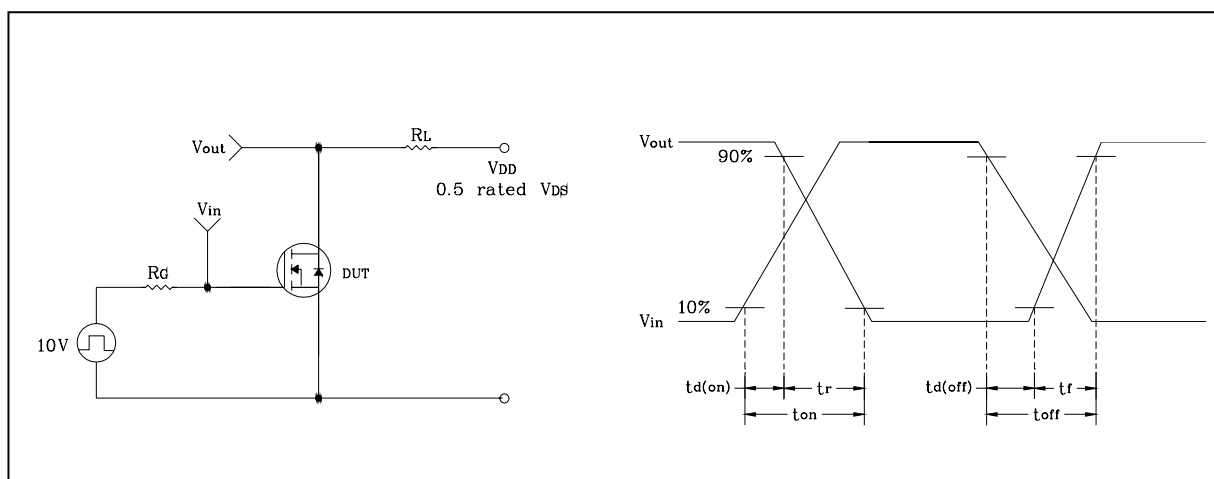

Fig. 14 Unclamped Inductive Switching Test Circuit & Waveform

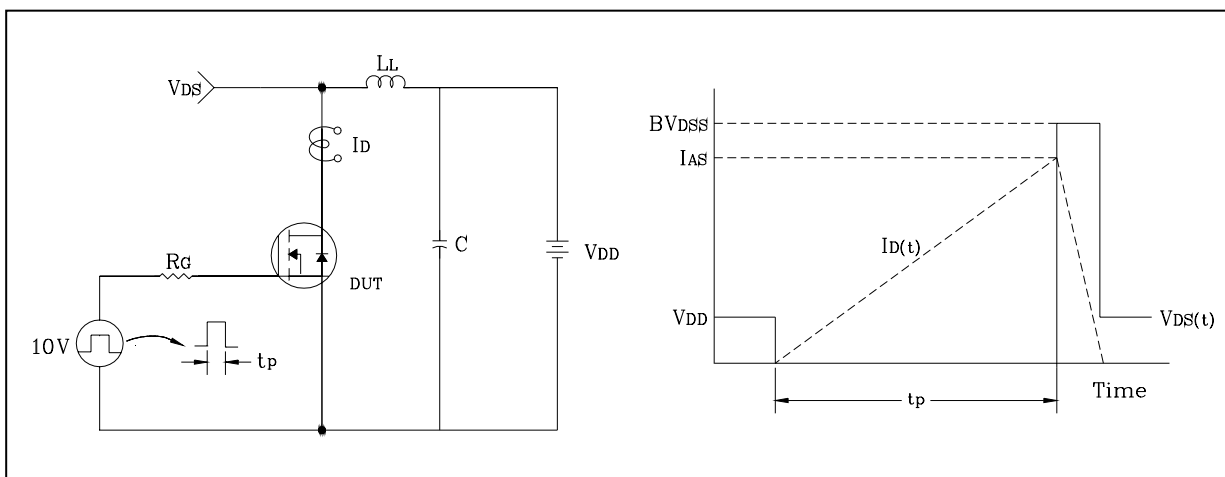
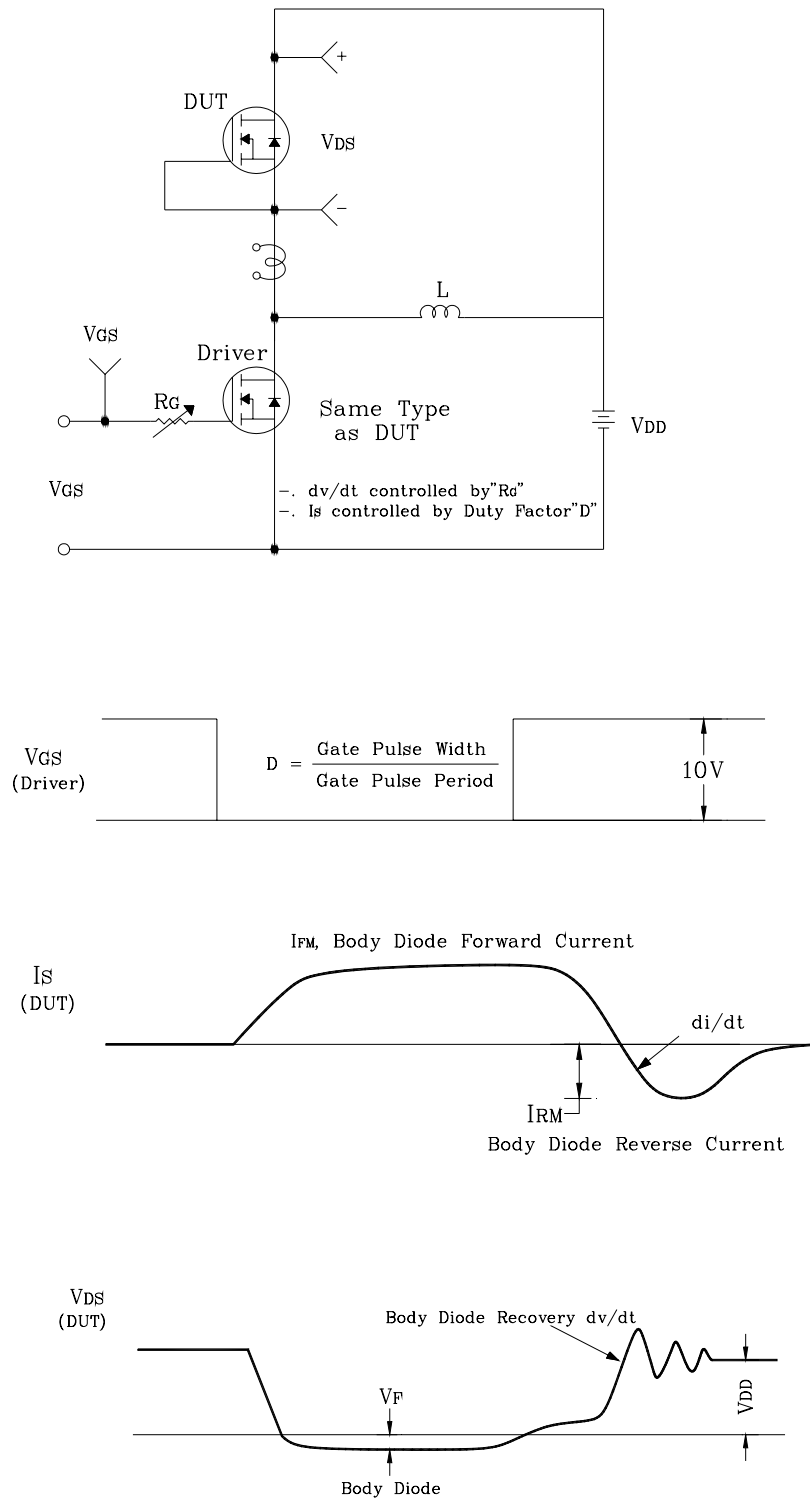

Fig. 15 Peak Diode Recovery dv/dt Test Circuit & Waveform



**These AUK products are intended for usage in general electronic equipments(Office and communication equipment, measuring equipment, domestic electrification, etc.).**

**Please make sure that you consult with us before you use these AUK products in equipments which require high quality and/or reliability, and in equipments which could have major impact to the welfare of human life(atomic energy control, airplane, spaceship, traffic signal, combustion central, all types of safety device, etc.).**

**AUK cannot accept liability to any damage which may occur in case these AUK products were used in the mentioned equipments without prior consultation with AUK.**