

TOSHIBA CMOS LINEAR INTEGRATED CIRCUIT SILICON MONOLITHIC

TC75S58F, TC75S58FU

SINGLE COMPARATOR

TC75S58F, TC75S58FU are CMOS type general-purpose single comparator capable of single power supply operation and using lower supply currents than the conventional bipolar comparators. Its open drain output forms wired OR with other open drain outputs.

FEATURES

- Low supply current : $I_{DD} = 10\mu A$ (Typ.)
- Single power supply operation
- Wide common mode input voltage range : $V_{SS} \sim V_{DD} - 0.9V$
- Open drain output circuit
- Low input bias current
- Small package

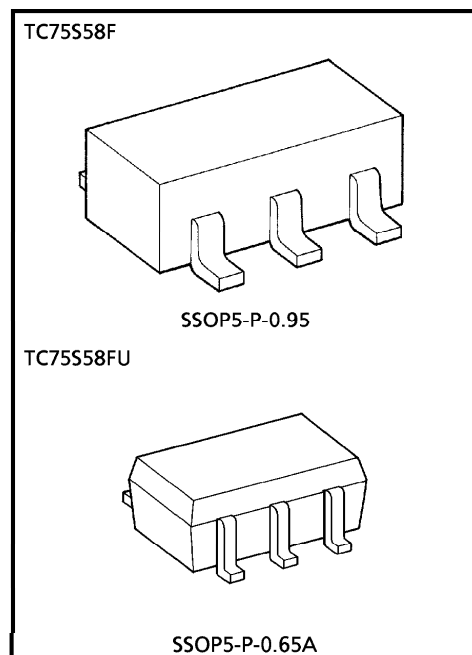

Weight
 SSOP5-P-0.95 : 0.014g (Typ.)
 SSOP5-P-0.65A : 0.006g (Typ.)

MARKING (TOP VIEW)

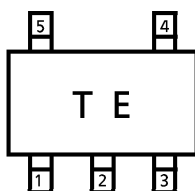

PIN CONNECTION (TOP VIEW)

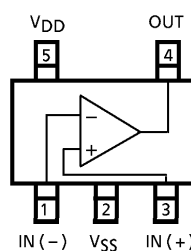

961001EBA1

- TOSHIBA is continually working to improve the quality and the reliability of its products. Nevertheless, semiconductor devices in general can malfunction or fail due to their inherent electrical sensitivity and vulnerability to physical stress. It is the responsibility of the buyer, when utilizing TOSHIBA products, to observe standards of safety, and to avoid situations in which a malfunction or failure of a TOSHIBA product could cause loss of human life, bodily injury or damage to property. In developing your designs, please ensure that TOSHIBA products are used within specified operating ranges as set forth in the most recent products specifications. Also, please keep in mind the precautions and conditions set forth in the TOSHIBA Semiconductor Reliability Handbook.
- The products described in this document are subject to foreign exchange and foreign trade control laws.
- The information contained herein is presented only as a guide for the applications of our products. No responsibility is assumed by TOSHIBA CORPORATION for any infringements of intellectual property or other rights of the third parties which may result from its use. No license is granted by implication or otherwise under any intellectual property or other rights of TOSHIBA CORPORATION or others.
- The information contained herein is subject to change without notice.

MAXIMUM RATINGS (Ta = 25°C)

CHARACTERISTIC	SYMBOL	RATING	UNIT
Supply Voltage	V _{DD} , V _{SS}	± 3.5 or 7	V
Differential Input Voltage	DV _{IN}	± 7	V
Input Voltage	V _{IN}	V _{SS} ~V _{DD}	V
Output Current	I _O	± 35	mA
Power Dissipation	P _D	200	mW
Operating Temperature	T _{opr}	- 40~85	°C
Storage Temperature	T _{stg}	- 55~125	°C

(Note) Since this product sometimes brings about latchup, which is peculiar to CMOS devices, note the following points :

- Don't raise the voltage level of I/O pins beyond V_{DD}, nor lower it below V_{SS}. Consider the timing for power supply, too.
- Don't let any abnormal noise enter the device.

ELECTRICAL CHARACTERISTICS ($V_{DD} = 5V$, $V_{SS} = GND$, $T_a = 25^\circ C$)

CHARACTERISTIC	SYMBOL	TEST CIR-CUIT	TEST CONDITION	MIN.	TYP.	MAX.	UNIT
Input Offset Voltage	V_{IO}	—	—	—	± 1	± 7	mV
Input Offset Current	I_{IO}	—	—	—	1	—	pA
Input Bias Current	I_I	—	—	—	1	—	pA
Common Mode Input Voltage	CMV_{IN}	—	—	0	—	4.1	V
Supply Current	I_{DD} (Note)	—	—	—	11	22	μA
Voltage Gain	G_V	—	—	—	94	—	dB
Sink Current	I_{sink}	—	$V_{OL} = 0.5V$	13	25	—	mA
Output Leak Current	I_{LEAK}	—	$V_O = 5V$	—	5	—	nA
Output Voltage	V_{OL}	—	$I_{sink} = 5.0mA$	—	0.1	0.3	V
Operating Supply Voltage	V_{DD}	—	—	1.8	—	7.0	V
Propagation Delay Time (Turn ON)	t_{PLH} (1)	—	Over drive = 100mV	—	800	—	ns
	t_{PLH} (2)	—	TTL step input	—	620	—	
Propagation Delay Time (Turn OFF)	t_{PHL} (1)	—	Over drive = 100mV	—	230	—	ns
	t_{PHL} (2)	—	TTL step input	—	350	—	
Response Time	t_{TLH}	—	Over drive = 100mV	—	190	—	ns
	t_{THL}	—	Over drive = 100mV	—	6	—	

ELECTRICAL CHARACTERISTICS ($V_{DD} = 3V$, $V_{SS} = GND$, $T_a = 25^\circ C$)

CHARACTERISTIC	SYMBOL	TEST CIR-CUIT	TEST CONDITION	MIN.	TYP.	MAX.	UNIT
Input Offset Voltage	V_{IO}	—	—	—	± 1	± 7	mV
Input Offset Current	I_{IO}	—	—	—	1	—	pA
Input Bias Current	I_I	—	—	—	1	—	pA
Common Mode Input Voltage	CMV_{IN}	—	—	0	—	2.1	V
Supply Current	I_{DD} (Note)	—	—	—	10	20	μA
Sink Current	I_{sink}	—	$V_{OL} = 0.5V$	6	18	—	mA
Output Leak Current	I_{LEAK}	—	$V_O = 3V$	—	5	—	nA
Output Voltage	V_{OL}	—	$I_{sink} = 5.0mA$	—	0.15	0.35	V
Propagation Delay Time (Turn ON)	t_{PLH}	—	Over drive = 100mV	—	590	—	ns
Propagation Delay Time (Turn OFF)	t_{PHL}	—	Over drive = 100mV	—	230	—	ns
Response Time	t_{TLH}	—	Over drive = 100mV	—	170	—	ns
	t_{THL}	—	Over drive = 100mV	—	5	—	

(Note) Since this product causes an increase in current consumption with a rise in operational frequency, make sure that power consumption does not exceed the allowable dissipation.

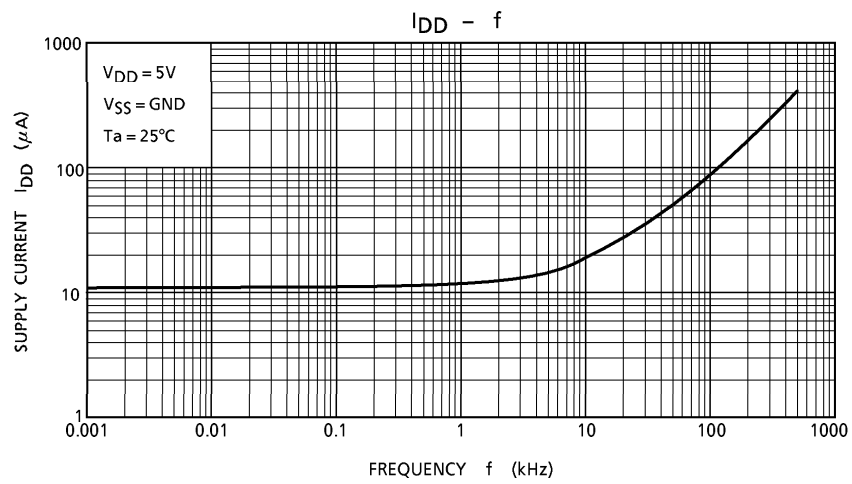
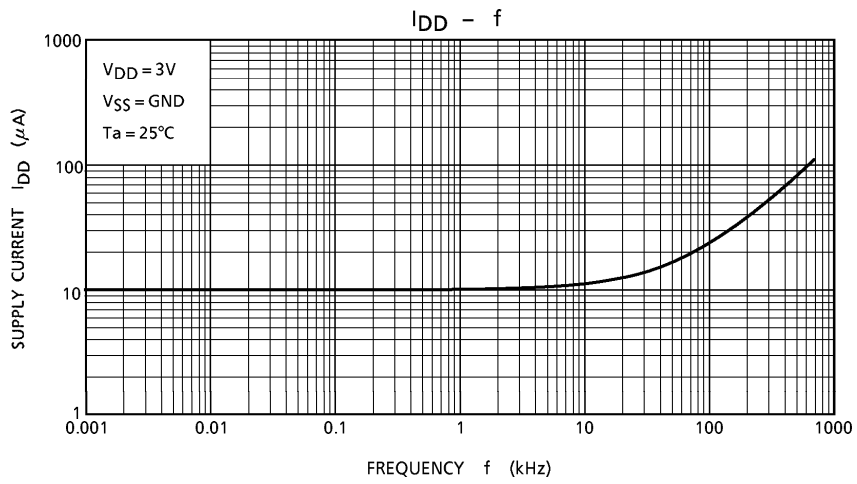

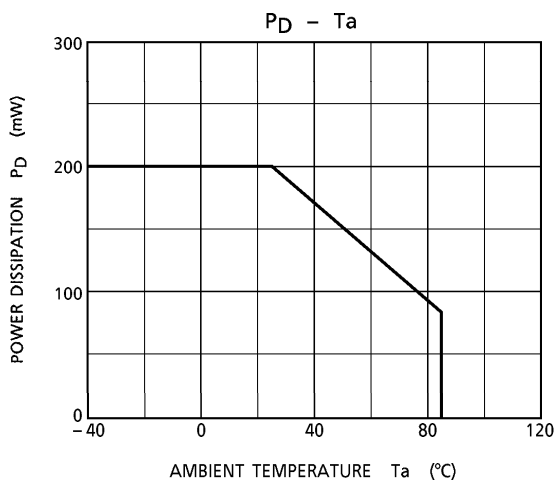
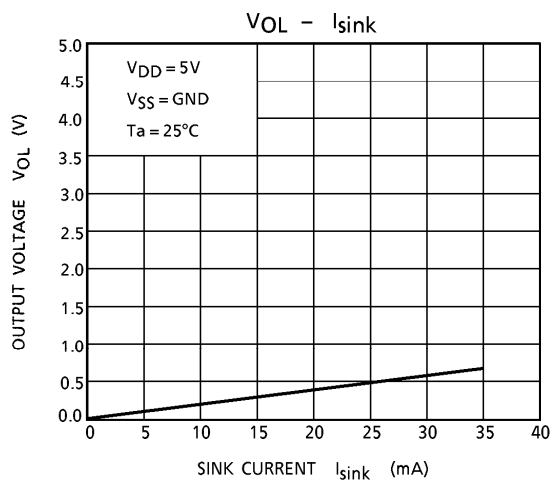
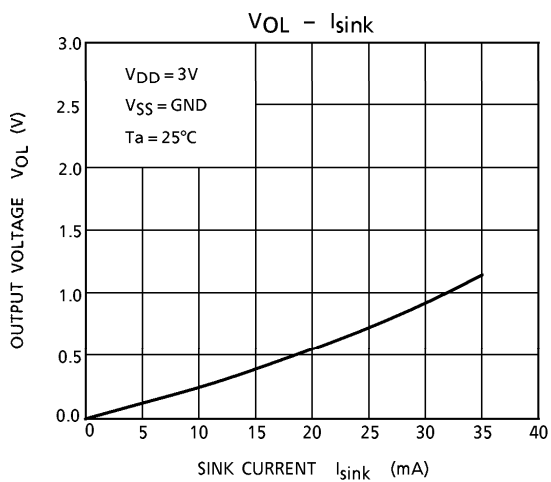

OUTLINE DRAWING
SSOP5-P-0.95

Unit : mm

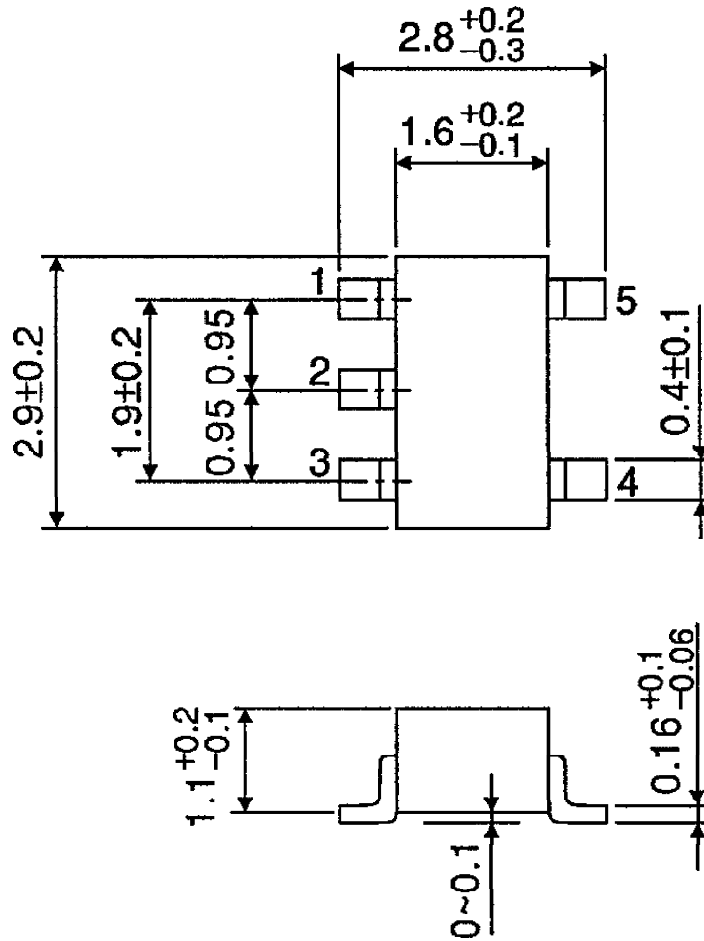

Weight : 0.014g (Typ.)

OUTLINE DRAWING
SSOP5-P-0.65A

Unit : mm

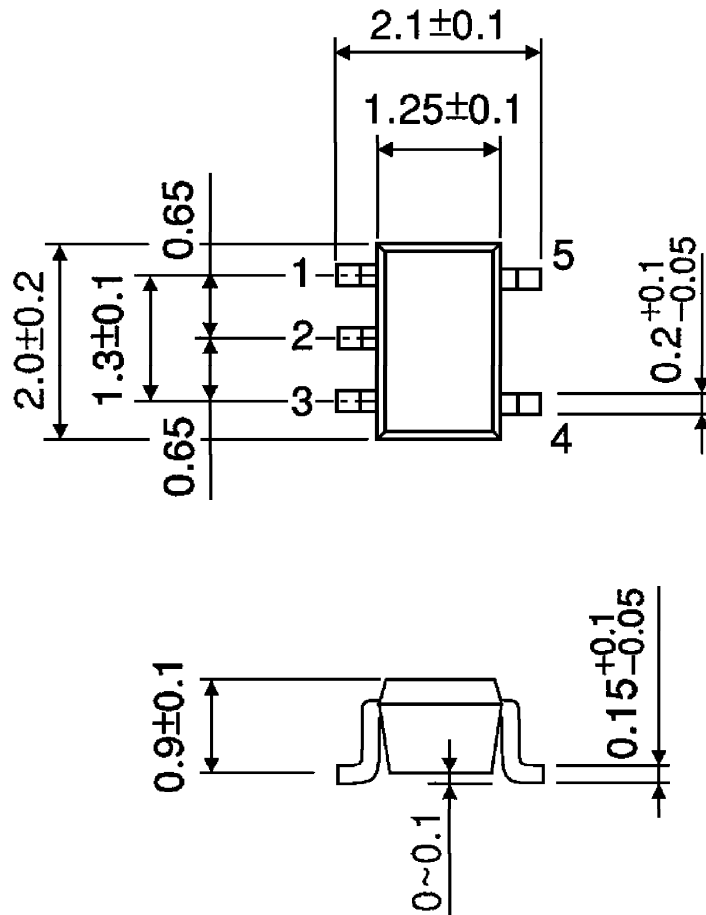

Weight : 0.006g (Typ.)