

AN6555, AN6556, AN6556S

Low Noise Dual Operational Amplifiers

Overview

The AN6555, the AN6556, and the AN6556S are low noise, high slew rate dual operational amplifiers with phase compensation circuits built-in.

They are suitable for applications to various electronic circuits such as active filters and audio preamplifiers.

Features

- Phase compensation circuit
- High voltage gain: $G_v=100$ dB typ.
- Low noise: input referred noise voltage $V_{ni}=1.5\mu$ Vrms typ.
- High slew rate: $SR=2V/\mu$ s typ.
- Output short-circuit protection

Block Diagram

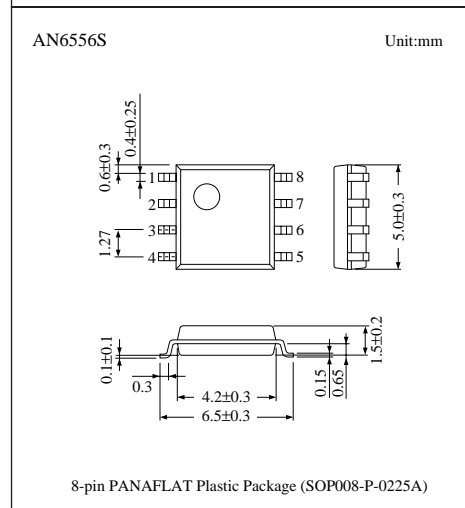
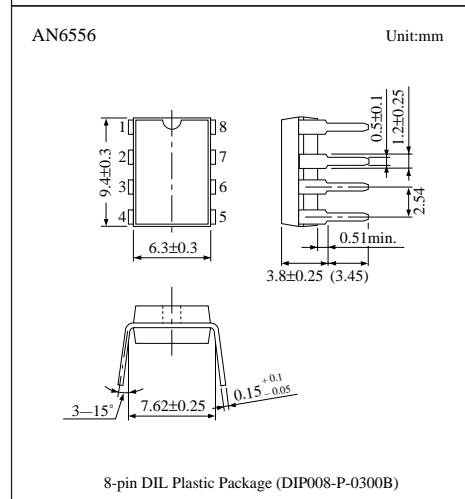
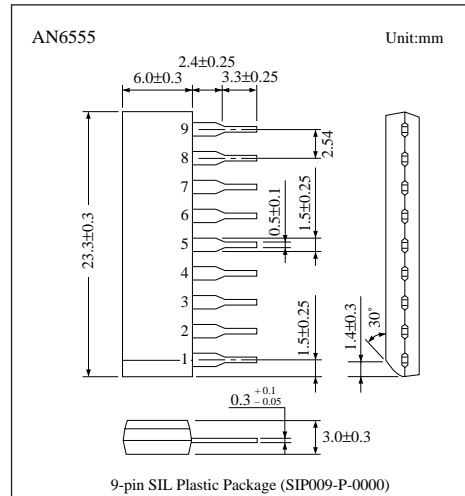
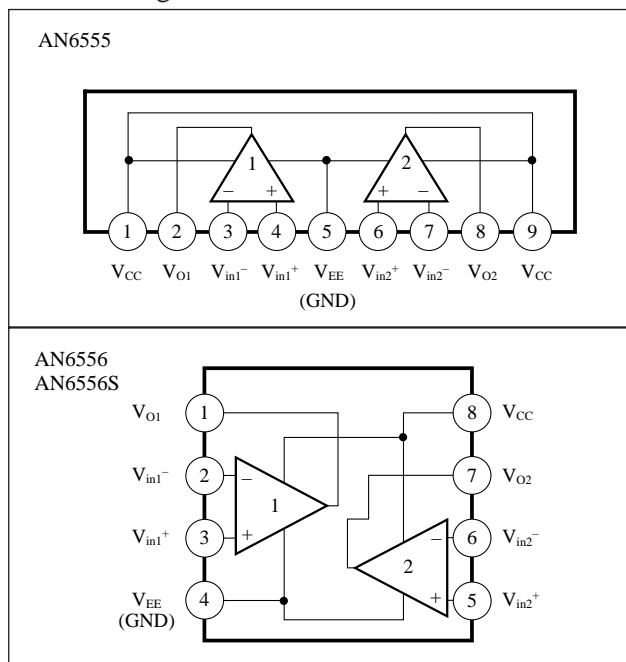

■ Pin Descriptions

〈AN6555〉

Pin No.	Pin name
1	V _{CC}
2	Ch.1 output
3	Ch.1 inverting input
4	Ch.1 non inverting input
5	V _{EE} (GND)
6	Ch.2 non inverting input
7	Ch.2 inverting input
8	Ch.2 output
9	V _{CC}

〈AN6556, AN6556S〉

Pin No.	Pin name
1	Ch.1 output
2	Ch.1 inverting input
3	Ch.1 non inverting input
4	V _{EE} (GND)
5	Ch.2 non inverting input
6	Ch.2 inverting input
7	Ch.2 output
8	V _{CC}

■ Absolute Maximum Ratings (Ta=25°C)

Parameter		Symbol	Rating	Unit
Voltage	Supply voltage	V _{CC}	±18	V
	Differential input voltage	V _{ID}	±30	V
	Common-mode input voltage	V _{ICM}	±15	V
Power dissipation	AN6555, AN6556	P _D	500	mW
	AN6556S		360	
Operating ambient temperature		T _{opr}	-20 to +75	°C
Storage temperature	AN6555, AN6556	T _{stg}	-55 to +150	°C
	AN6556S		-55 to +125	

■ Electrical Characteristics (V_{CC}=15V, V_{EE}=-15V, Ta=25°C)

Parameter	Symbol	Condition	min	typ	max	Unit
Input offset voltage	V _{I (offset)}	R _S ≤ 10kΩ	—	0.5	6	mV
Input offset current	I _{IO}		—	5	200	nA
Input bias current	I _{Bias}		—	—	500	nA
Voltage gain	G _V	R _L ≥ 2kΩ, V _O = ±10V	86	100	—	dB
Maximum output voltage	V _{O (max.)}	R _L ≥ 10kΩ	±12	±14	—	V
		R _L ≥ 2kΩ	±10	±13	—	V
Common-mode input voltage width	V _{CM}		±12	±14	—	V
Common-mode rejection ratio	CMR		70	90	—	dB
Supply voltage rejection ratio	SVR		—	30	150	μV/V
Power consumption	P _C	R _L = ∞	—	90	170	mW
Slew rate	SR	R _L ≥ 2kΩ	—	2	—	V/μs
Equivalent input noise voltage	V _{ni}	R _S = 1kΩ, DIN/AUDIO	—	1.5	—	μV _{rms}

■ Characteristics Curve

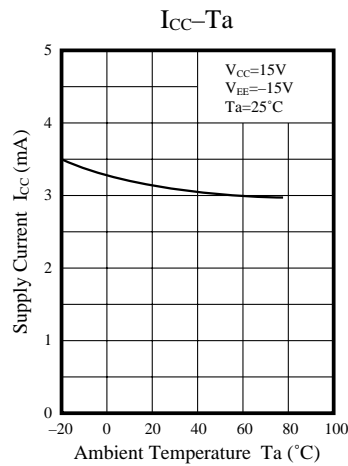
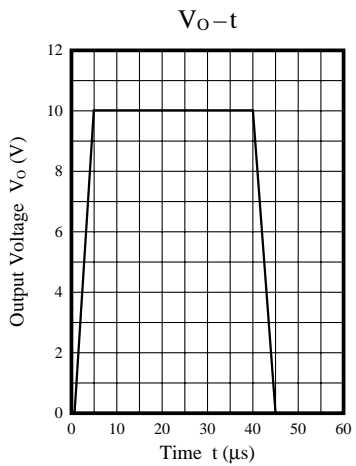
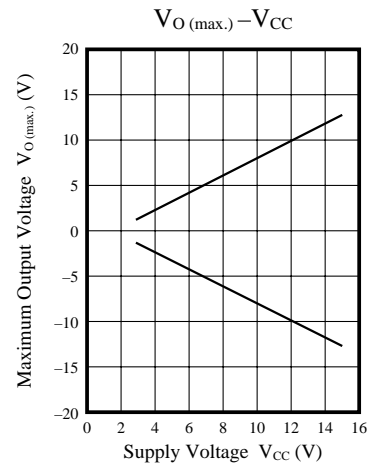
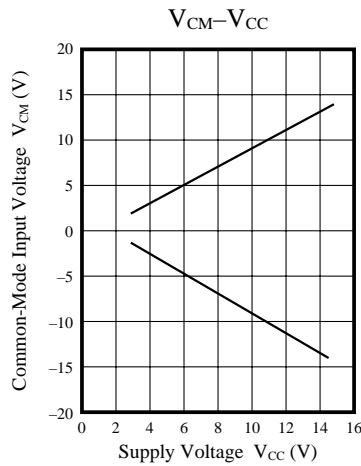
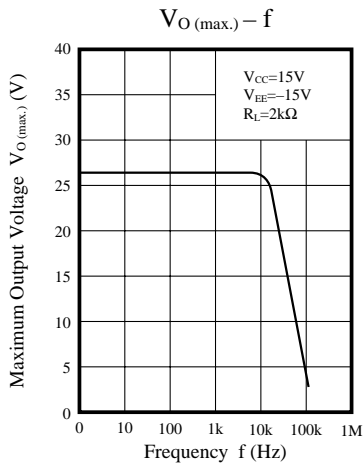
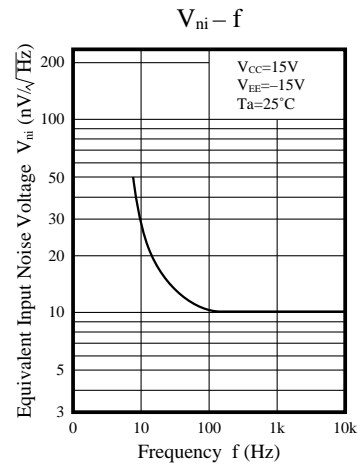
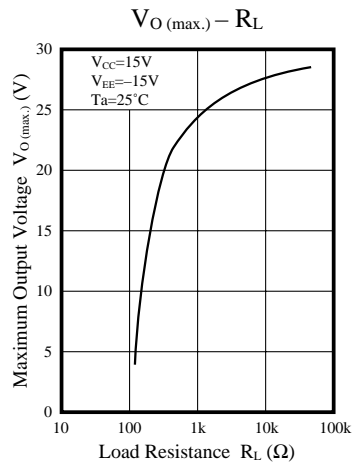
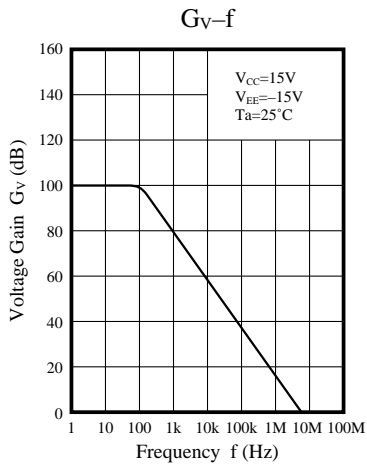

■ Application Circuit

