

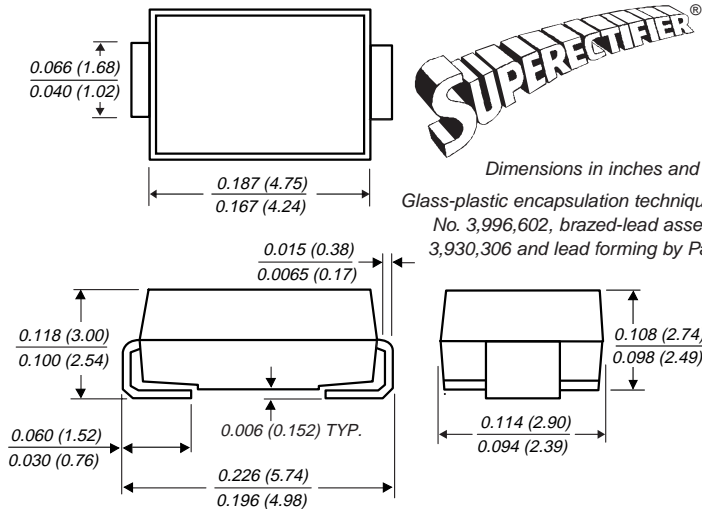

**Surface Mount Glass Passivated Junction
Fast Switching Rectifier**

Reverse Voltage 50 to 1000V
Forward Current 1.0A

DO-214BA (GF1)



Patented*

Dimensions in inches and (millimeters)
Glass-plastic encapsulation technique is covered by Patent No. 3,996,602, brazed-lead assembly by Patent No. 3,930,306 and lead forming by Patent No. 5,151,846

Mounting Pad Layout

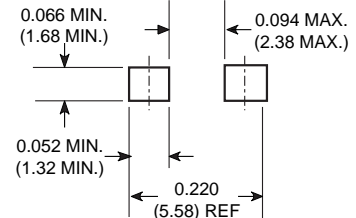

Features

- Plastic package has Underwriters Laboratories Flammability Classification 94V-0
- Ideal for surface mount automotive applications
- High temperature metallurgically bonded construction
- Cavity-free glass passivated junction
- Capable of meeting environmental standards of MIL-S-19500
- Built-in strain relief • Easy pick and place
- Fast switching for high efficiency
- High temperature soldering guaranteed: 450°C/5 seconds at terminals.
- Complete device submersible temperature of 265°C for 10 seconds in solder bath

Mechanical Data

Case: JEDEC DO-214BA, molded plastic over glass body
Terminals: Solder plated, solderable per MIL-STD-750, Method 2026
Polarity: Color band denotes cathode end
Mounting Position: Any **Weight:** 0.0048 oz, 0.12 g
Packaging codes/options:
19/6.5K per 13" Reel (12mm Tape)
17/1.5K per 7" Reel (12mm Tape)

Maximum Ratings & Thermal Characteristics

Ratings at 25°C ambient temperature unless otherwise specified.

Parameter	Symbol	RGF1A	RGF1B	RGF1D	RGF1G	RGF1J	RGF1K	RGF1M	Unit
Device marking code		RA	RB	RD	RG	RJ	RK	RM	
Maximum repetitive peak reverse voltage	V _{RRM}	50	100	200	400	600	800	1000	V
Maximum RMS voltage	V _{RMS}	35	70	140	280	420	560	700	V
Maximum DC blocking voltage	V _{DC}	50	100	200	400	600	800	1000	V
Maximum average forward rectified current at T _L = 120°C	I _{F(AV)}	1.0							A
Peak forward surge current 8.3ms single half sine-wave superimposed on rated load (JEDEC Method)	I _{FSM}	30							A
Max. full load reverse current, full cycle average T _A = 55°C	I _{R(AV)}	50							μA
Typical thermal resistance ⁽¹⁾	R _{θJA} R _{θJL}	80 28							°C/W
Operating junction and storage temperature range	T _J , T _{STG}	-65 to +175							°C

Electrical Characteristics (T_J = 25°C unless otherwise noted)

Parameter	Symbol	RGF1A	RGF1B	RGF1D	RGF1G	RGF1J	RGF1K	RGF1M	Unit
Maximum instantaneous forward voltage at 1.0A	V _F	1.30							V
Maximum DC reverse current T _A = 25°C at rated DC blocking voltage T _A = 125°C	I _R	5.0 100							μA
Typical reverse recovery time at I _F = 0.5A, I _R = 1.0A, I _{rr} = 0.25 A	t _{rr}	150			250		500		ns
Typical junction capacitance at 4.0V, 1MHz	C _J	8.5							pF

Note: (1) Thermal resistance from junction to ambient and from junction to lead, P.C.B. mounted on 0.2 x 0.2" (5.0 x 5.0mm) copper pad areas

Ratings and Characteristic Curves ($T_A = 25^\circ\text{C}$ unless otherwise noted)

Fig. 1 – Forward Current Derating Curve

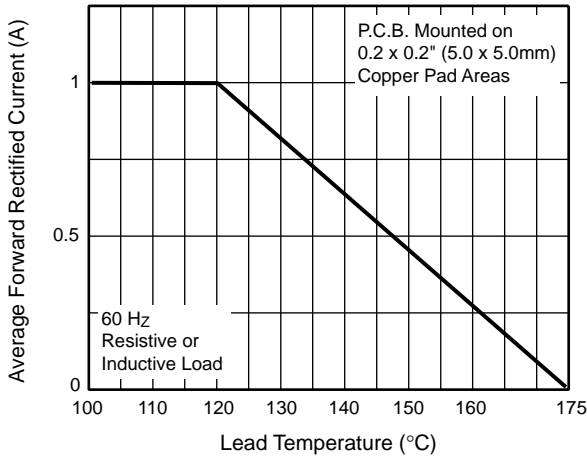

Fig. 2 – Maximum Non-Repetitive Peak Forward Surge Current

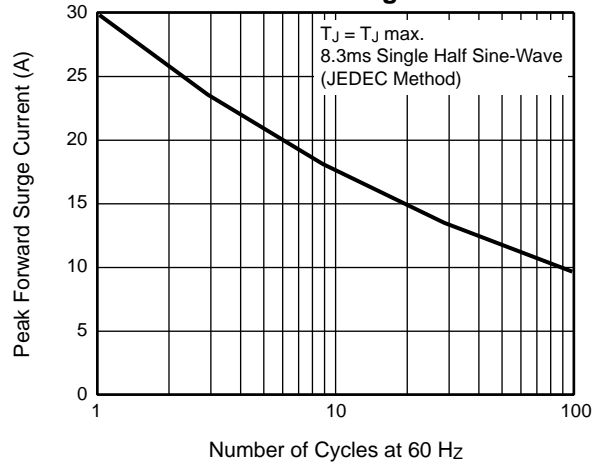

Fig. 3 – Typical Instantaneous Forward Characteristics

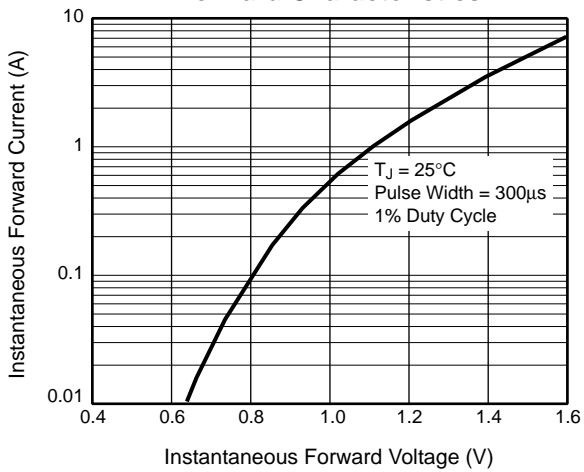

Fig. 4 – Typical Reverse Characteristics

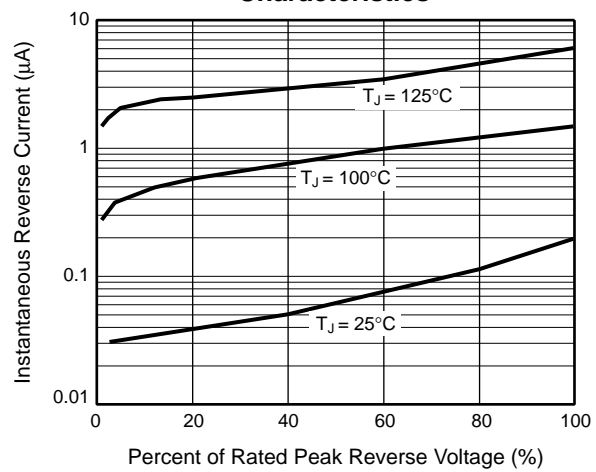

Fig. 5 – Typical Junction Capacitance

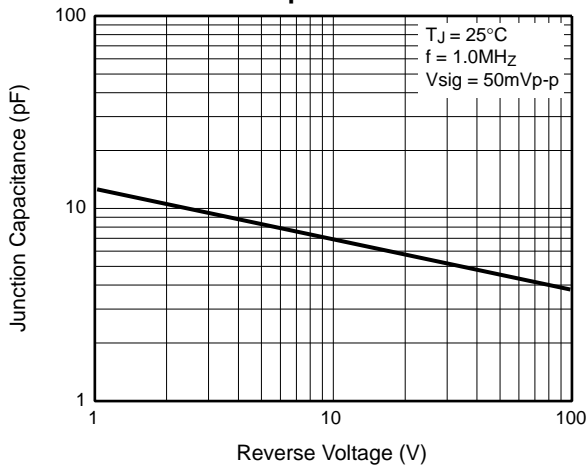

Fig. 6 – Typical Transient Thermal Impedance

