

TOSHIBA BIPOLAR LINEAR INTEGRATED CIRCUIT SILICON MONOLITHIC

# TA8246AH

## DUAL AUDIO POWER AMPLIFIER 6 W × 2 CH

The TA8246AH is dual power amplifier for Consumer applications.

This IC provides an output power of 6 watts per channel (at  $V_{CC} = 20\text{ V}$ ,  $f = 1\text{ kHz}$ ,  $\text{THD} = 10\%$ ,  $R_L = 8\ \Omega$ )

It is suitable for power amplifier of TV and home Stereo.

### FEATURES

- High Output Power
  - :  $P_{out} = 6\text{ W}$  (Typ.)
  - ( $V_{CC} = 20\text{ V}$ ,  $R_L = 8\ \Omega$ ,  $f = 1\text{ kHz}$ ,  $\text{THD} = 10\%$ )
- Built-in Audio Muting Circuit.
- NF Terminal Capacitor Less : Fixed Gain ( $G_v = 34\text{ dB}$ ), Needless External capacitor.
- Protectors
  - Thermal shut down Protection circuit, Over Voltage Protection circuit
- Low Popping Noise
- High THD Ratio
- High input dynamic range
- Available for using same PCB layout with 3 channel IC : TA8256H.
- Operating Supply Voltage Range :  $V_{CC}(\text{opr}) = 10\sim 30\text{ V}$  ( $T_a = 25^\circ\text{C}$ )

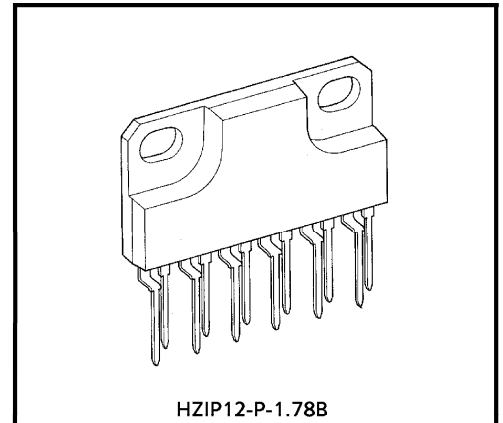

Weight : 4.04 g (Typ.)

980910EBA1

- TOSHIBA is continually working to improve the quality and the reliability of its products. Nevertheless, semiconductor devices in general can malfunction or fail due to their inherent electrical sensitivity and vulnerability to physical stress. It is the responsibility of the buyer, when utilizing TOSHIBA products, to observe standards of safety, and to avoid situations in which a malfunction or failure of a TOSHIBA product could cause loss of human life, bodily injury or damage to property. In developing your designs, please ensure that TOSHIBA products are used within specified operating ranges as set forth in the most recent products specifications. Also, please keep in mind the precautions and conditions set forth in the TOSHIBA Semiconductor Reliability Handbook.
- The products described in this document are subject to the foreign exchange and foreign trade laws.
- The information contained herein is presented only as a guide for the applications of our products. No responsibility is assumed by TOSHIBA CORPORATION for any infringements of intellectual property or other rights of the third parties which may result from its use. No license is granted by implication or otherwise under any intellectual property or other rights of TOSHIBA CORPORATION or others.
- The information contained herein is subject to change without notice.

BLOCK DIAGRAM

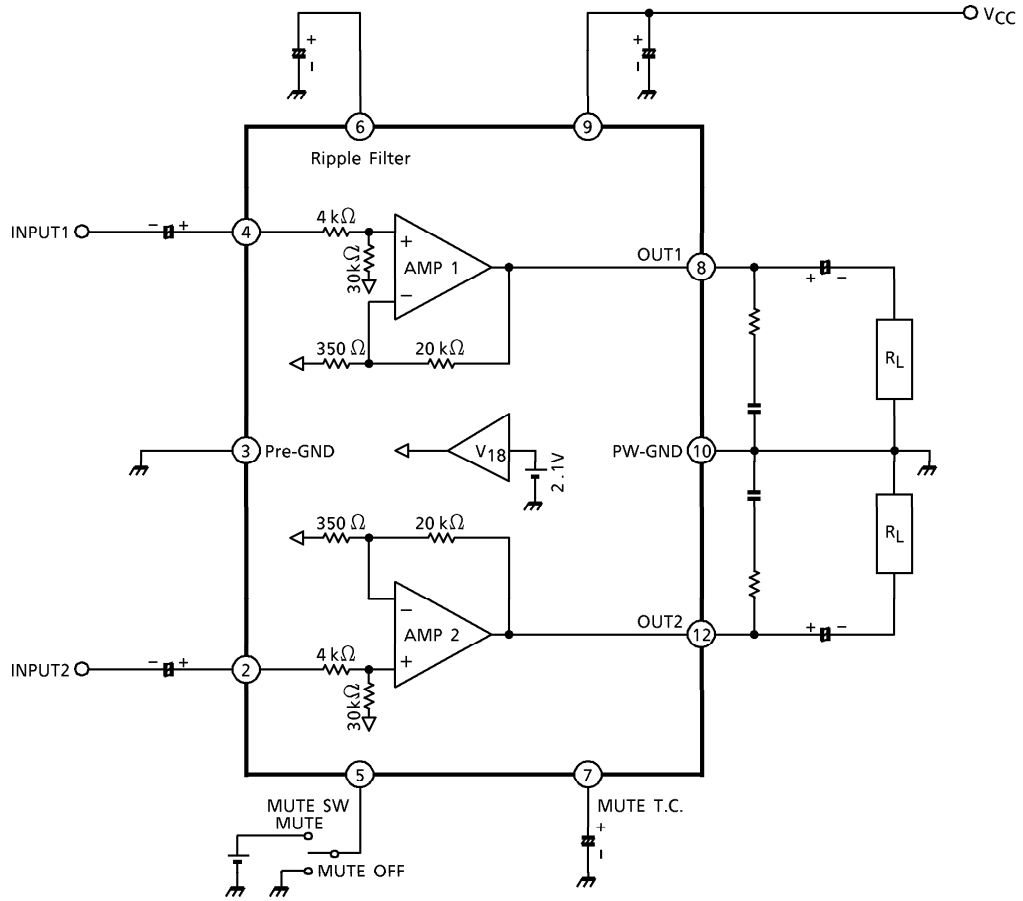

**TERMINAL EXPLANATION**

TERMINAL No.	SYMBOL	FUNCTION	EQUIVALENT CIRCUIT
2	IN1	Input	
4	IN2		
3	Pre-GND	GND terminal	—
5	MUTE SW	MUTE control terminal	
7	MUTE T.C.		
6	R.F.	Ripple filter	
8	OUT1	Output	
12	OUT2		
9	V <sub>CC</sub>	Supply voltage terminal	—
10	PW-GND	GND terminal	—

①, ⑩ : N.C

## MAXIMUM RATINGS (Ta = 25°C)

CHARACTERISTIC	SYMBOL	RATING	UNIT
Supply Voltage	V <sub>CC</sub>	30	V
Output Current (Peak/Ch)	I <sub>O(peak)</sub>	2	A
Power Dissipation	P <sub>D</sub> (Note)	25	W
Operating Temperature	T <sub>opr</sub>	-20~75	°C
Storage Temperature	T <sub>stg</sub>	-55~150	°C

(Note) Derated above Ta = 25°C in the proportion of 200 mW/°C.

## ELECTRICAL CHARACTERISTICS

(Unless otherwise specified, V<sub>CC</sub> = 20 V, R<sub>L</sub> = 8 Ω, R<sub>g</sub> = 620 Ω, f = 1 kHz, Ta = 25°C)

CHARACTERISTIC	SYMBOL	TEST CIRCUIT	TEST CONDITION	MIN.	TYP.	MAX.	UNIT
Quiescent Current	ICCQ	—	V <sub>in</sub> = 0	50	85	130	mA
Output Power	P <sub>out</sub> (1)	—	THD = 10%	5.0	6.0	—	W
	P <sub>out</sub> (2)	—	THD = 1%	—	4.5	—	
Total Harmonic Distortion	THD (1)	—	P <sub>out</sub> = 2 W	—	0.04	0.2	%
	THD (2)	—	P <sub>out</sub> = 2 W, f = 10 kHz	—	0.1	0.6	
Voltage Gain	G <sub>v</sub>	—	V <sub>out</sub> = 0.775 V <sub>rms</sub>	32.5	34.0	35.5	dB
Input Resistance	R <sub>in</sub>	—		—	34	—	kΩ
Ripple Rejection Ratio	R.R.	—	f = 100 Hz	-40	-47	—	dB
Output Noise Voltage	V <sub>no</sub>	—	R <sub>g</sub> = 10 kΩ, BW = 20 Hz~20 kHz	—	0.14	0.3	mV <sub>rms</sub>
Cross Talk	C.T.	—	R <sub>g</sub> = 10 kΩ, V <sub>out</sub> = 0.775 V <sub>rms</sub>	—	-60	—	dB
Mute Control Voltage	V <sub>th</sub> (ON)	—	MUTE ON	3.1	—	V <sub>CC</sub>	V
	V <sub>th</sub> (OFF)	—	MUTE OFF	0	—	2.5	
Mute Attenuation Level	ATT	—	V <sub>out</sub> = 0.775 V <sub>rms</sub> → MUTE	-52	-60	—	dB

TEST CIRCUIT

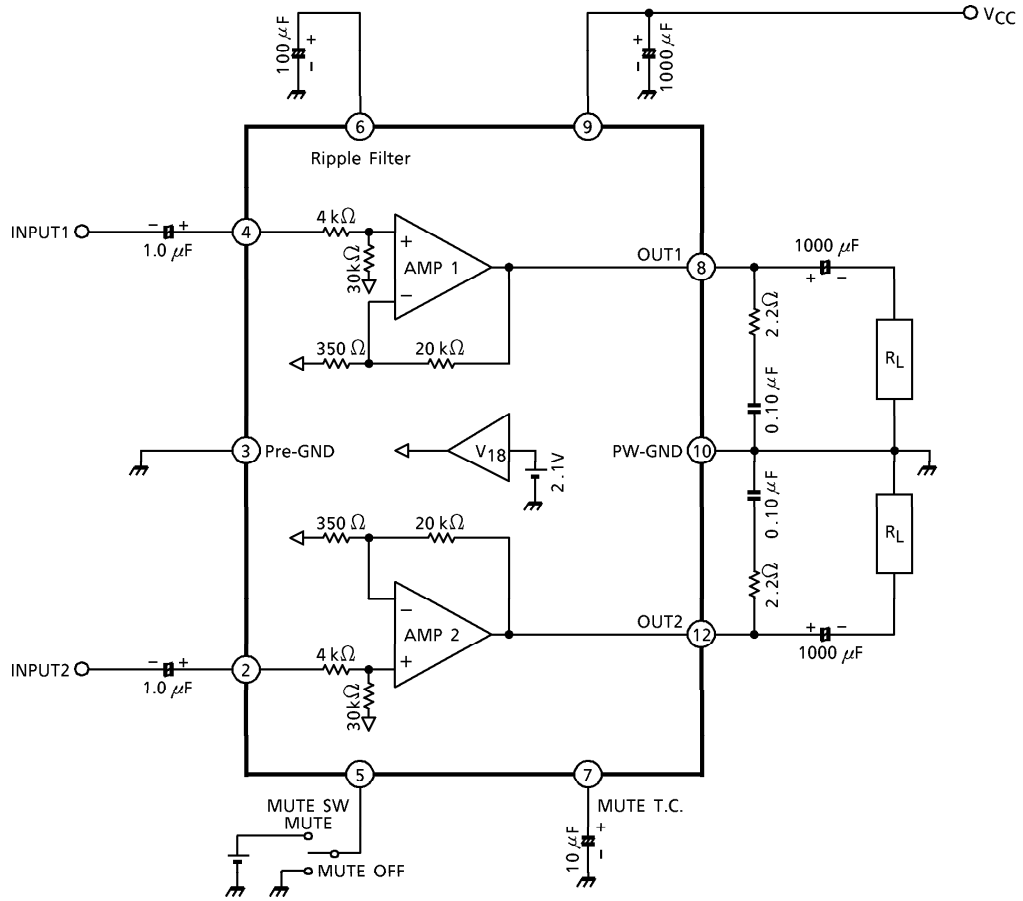

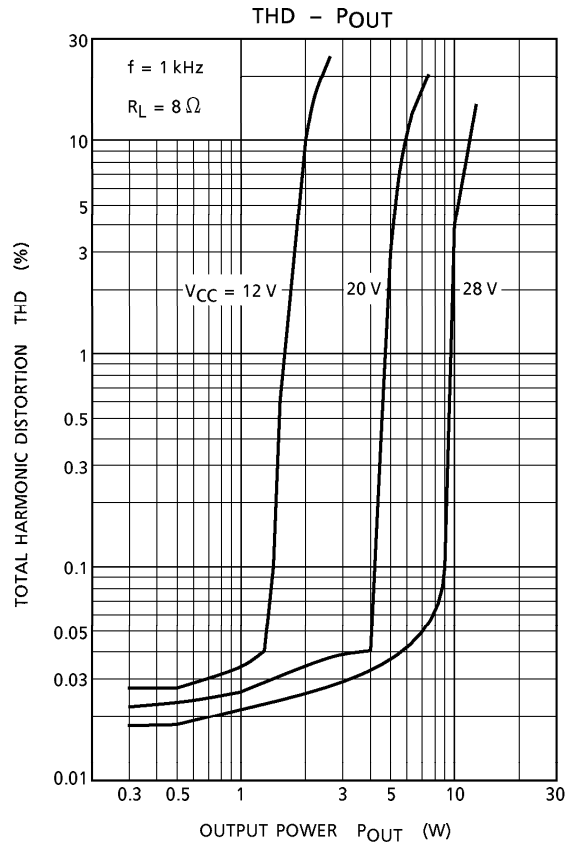
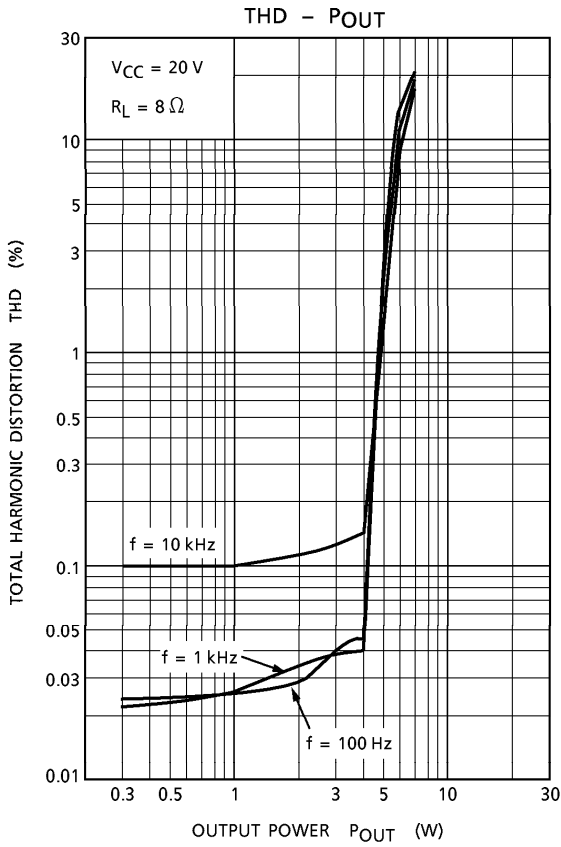
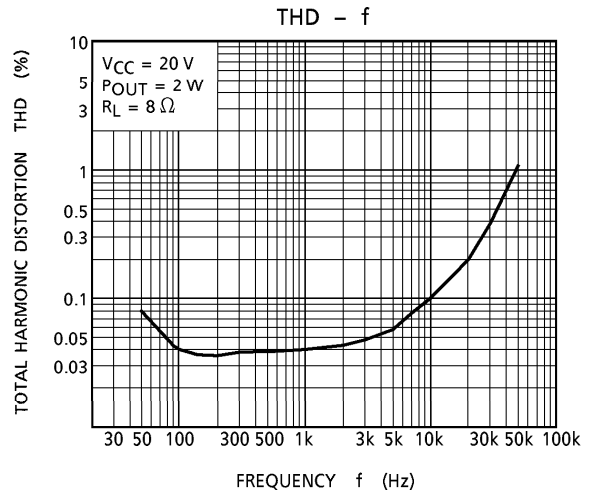
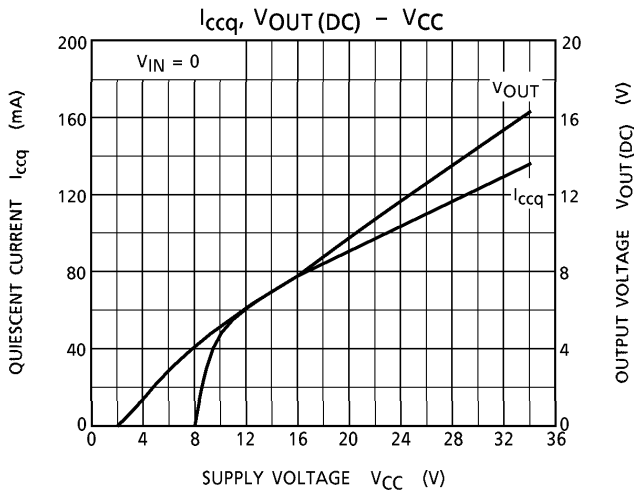

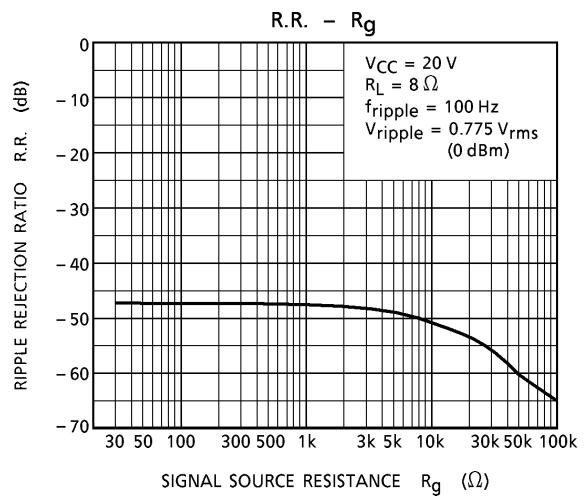
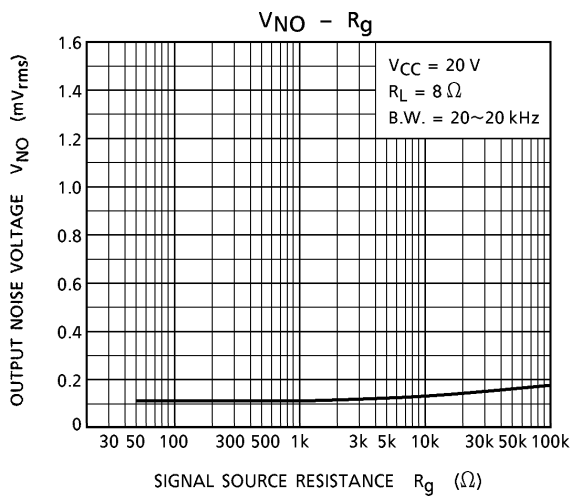
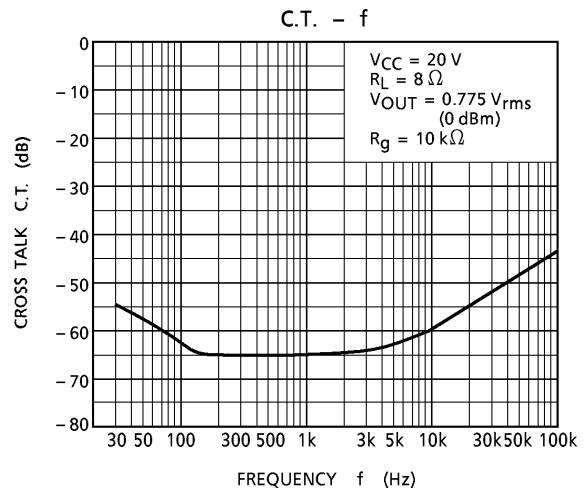
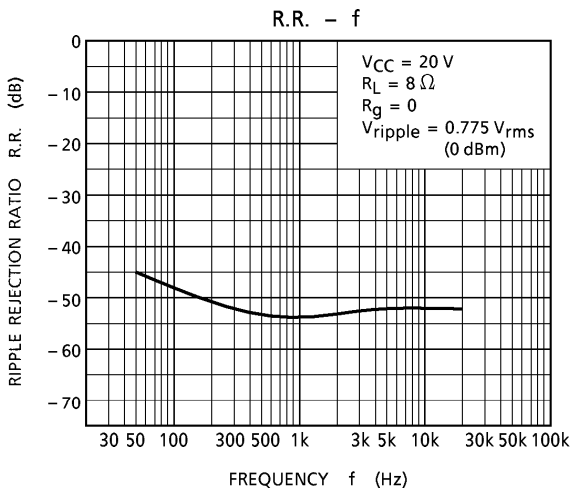
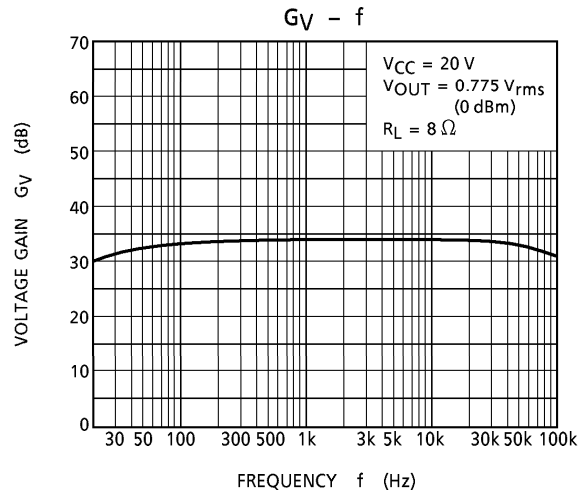
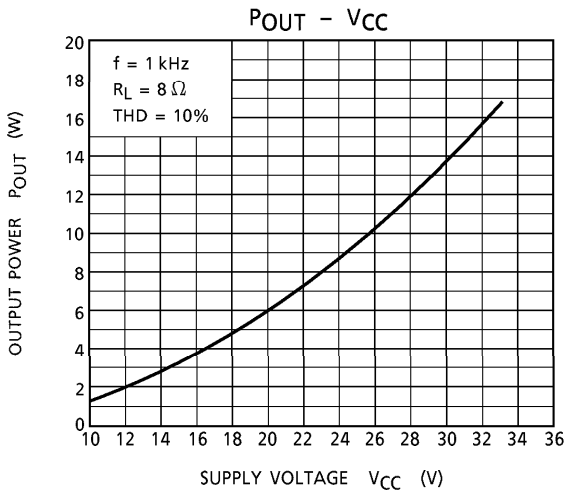

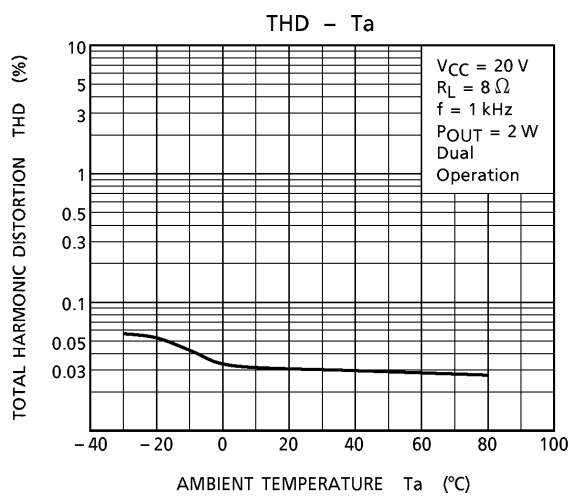
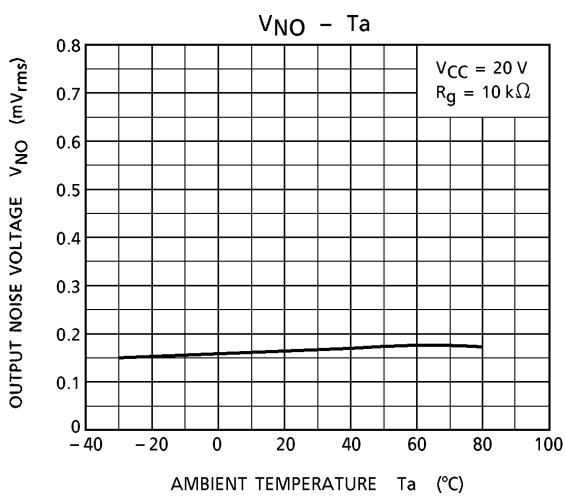
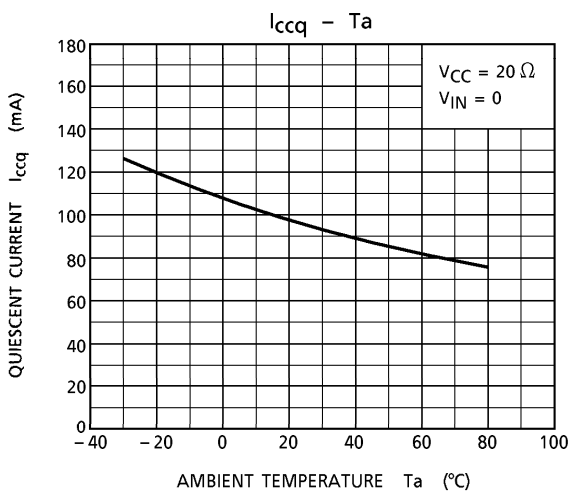
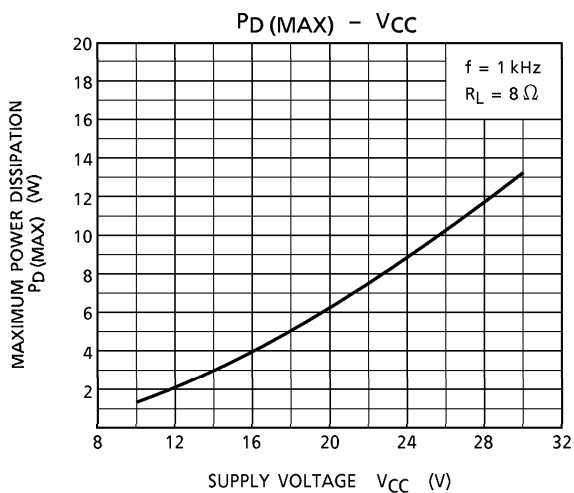
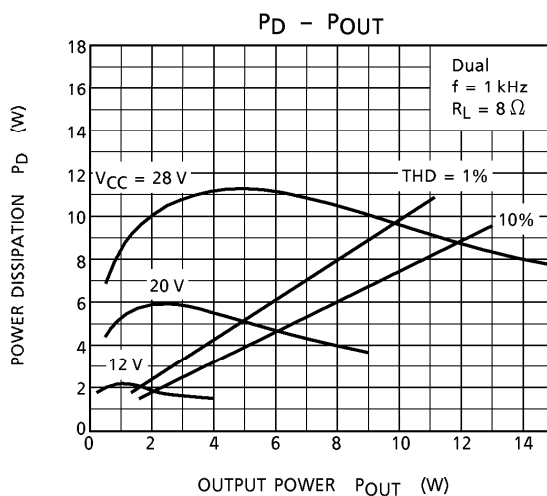
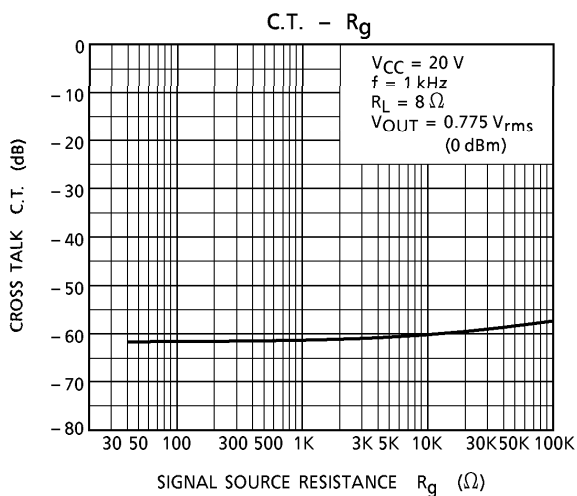



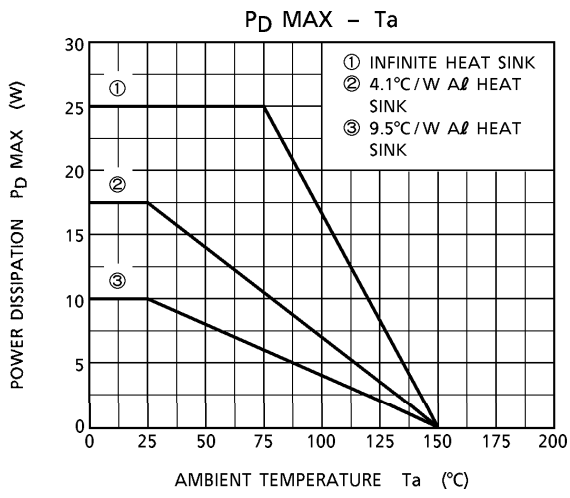

**OUTLINE DRAWING**  
HZIP12-P-1.78B

Unit : mm

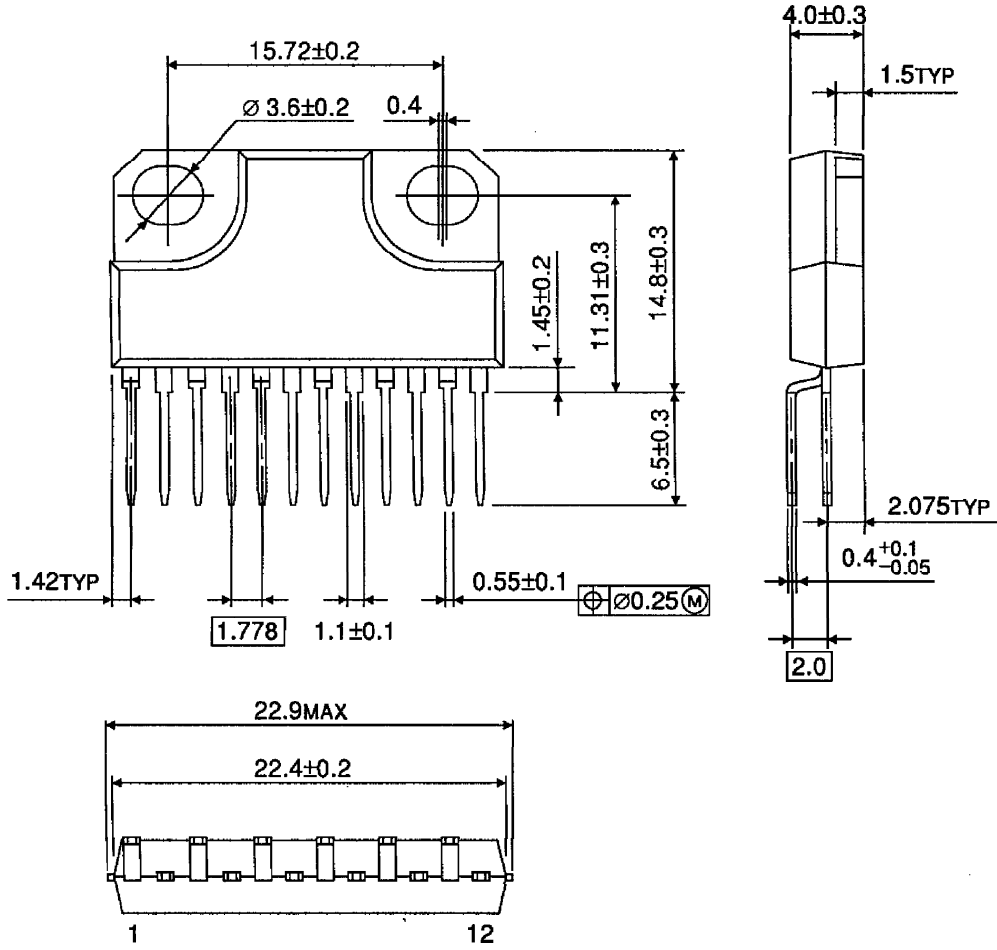

Weight : 4.04 g (Typ.)