

GPS Low Noise Amplifier using BGA622

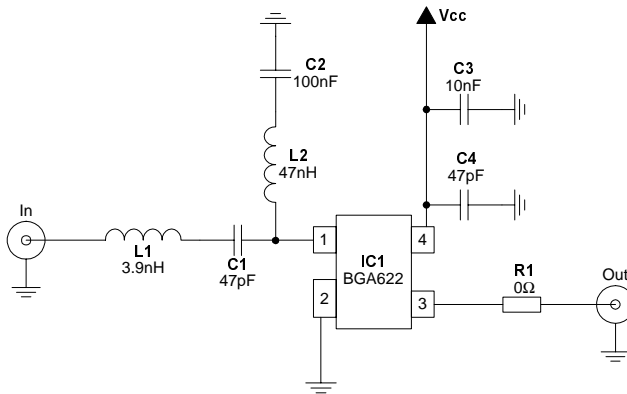

Figure 1 Application Circuit Diagram

Table 1 Measured Performance Data at 1575 MHz and $V_{CC} = 3$ V.

Parameter	Symbol	Value	Unit
Supply current	I_{CC}	5.8	mA
Insertion power gain	$ S_{21} ^2$	15.4	dB
Noise figure	NF	1.3	dB
Input return loss	$ S_{11} ^2$	13.7	dB
Output return loss	$ S_{22} ^2$	14.5	dB
Reverse isolation	$ S_{12} ^2$	27.5	dB
Input 1 dB-compression point	IP_{1dB}	-16	dBm
Input third order intercept point ¹⁾	IIP_3	1	dBm

¹⁾ $\Delta f = 1$ MHz; $P_{in} = -25$ dBm

Table 2 Bill of Materials

Name	Value	Package	Manufacturer	Function
C1	47 pF	0402	various	DC block
C2	100 nF	0603	various	Improve linearity
C3	10 nF	0402	various	RF bypass
C4	47 pF	0402	various	RF bypass
IC1	BGA622	SOT343	Infineon Technologies	SiGe MMIC
L1	3.9 nH	0402	Toko LL 1005-FH	Input matching
L2	47 nH	0402	Toko LL 1005-FH	RF choke
R1	0 Ω	0402	various	Jumper

Measured Circuit Performance

All presented measurement values include losses of both PCB and connectors - in other words, the reference planes used for measurements are the PCB's RF SMA connectors. Noise figure and gain results shown do not have any PCB loss extracted from them.

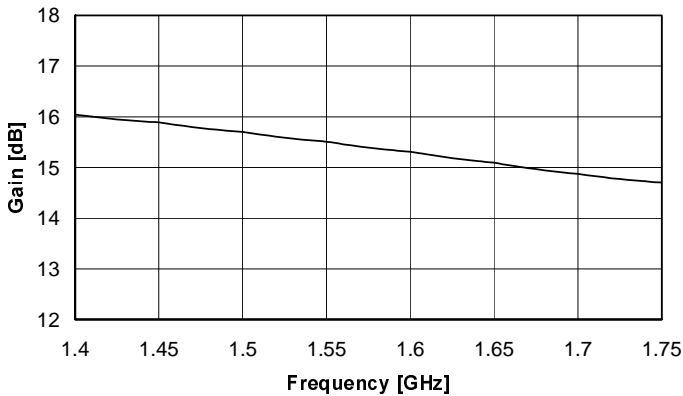

Figure 2 Insertion Gain

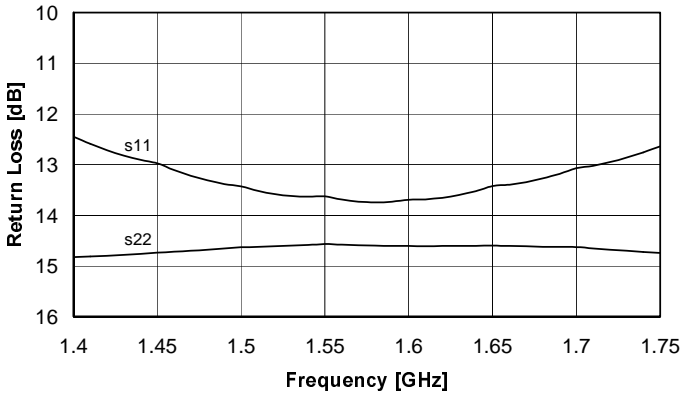

Figure 3 Input and Output Return Loss

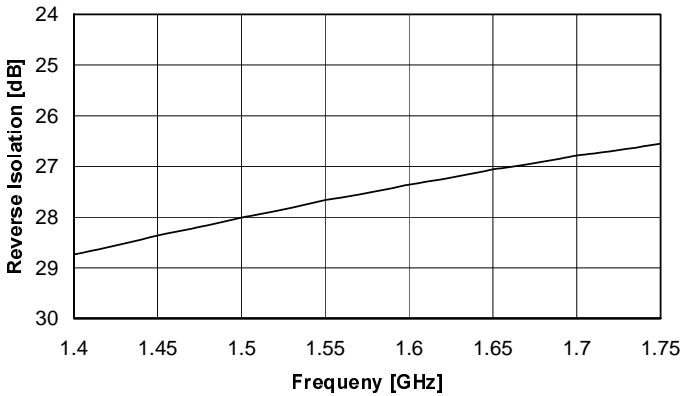

Figure 4 Reverse Isolation

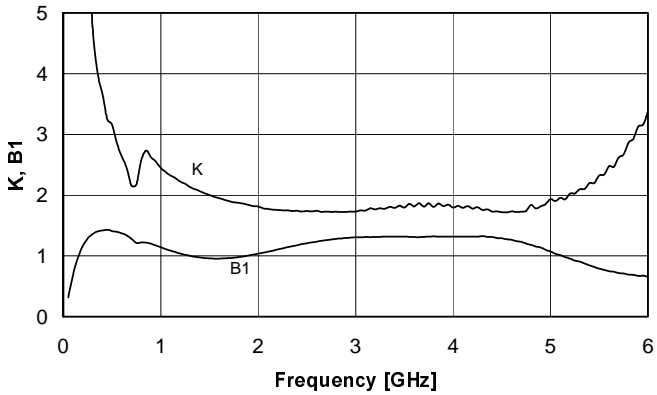

Figure 5 Stability Factor K and Stability Measure B1

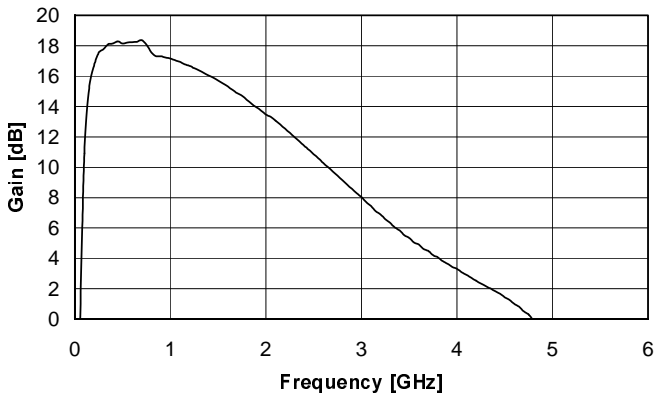

Figure 6 Wide Span Gain

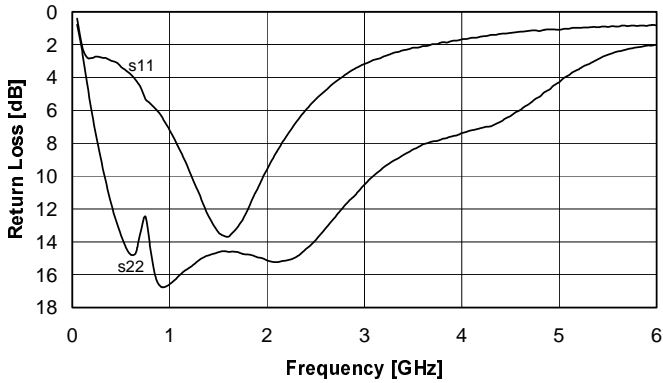

Figure 7 Wide Span Return Loss

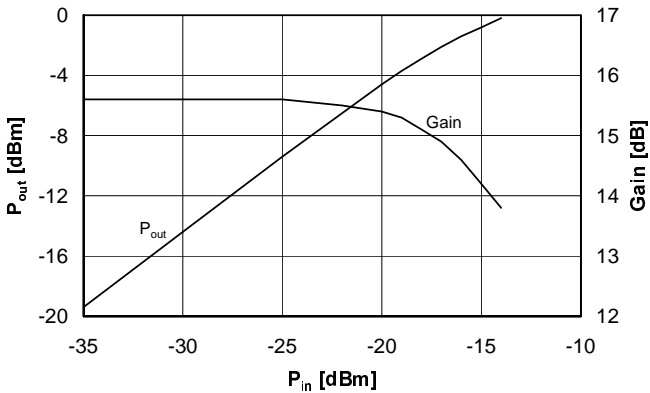

Figure 8 Gain Compression @ 1.575 GHz

Application board and component placement

Figure 9 shows the placement of the specific components on the application PCB.

Figure 10 displays the cross section of the application board. The actually used microstrip structure is the one with the 0.2 mm FR4 dielectric. The 0.8 mm FR4 are for mechanical rigidity purposes only.

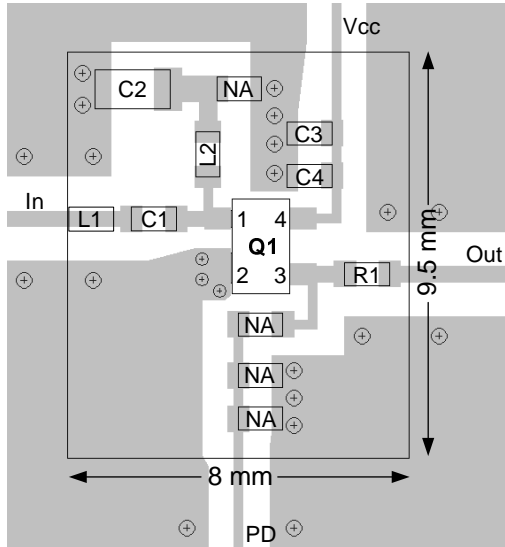

Figure 9 Component Placement on the Application PCB

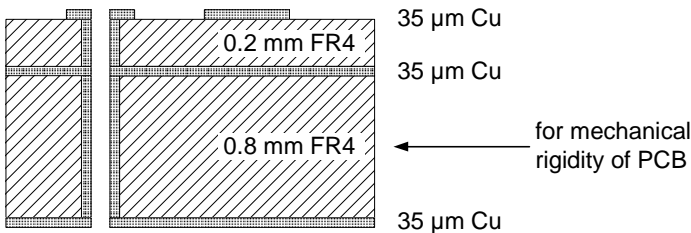

Figure 10 PCB Cross Section