

## SIPMOS<sup>®</sup> Small-Signal Transistor

- P channel
- Enhancement mode
- Logic Level
- $V_{GS(th)} = -0.8...-1.6\text{ V}$

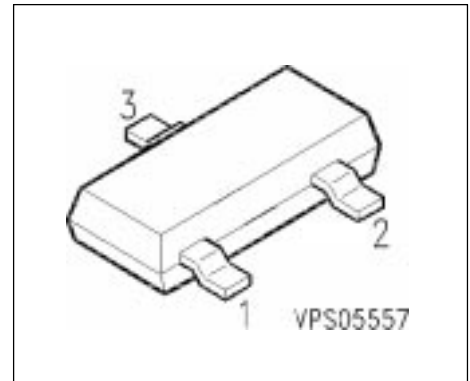

Pin 1	Pin 2	Pin 3
G	S	D

Type	$V_{DS}$	$I_D$	$R_{DS(on)}$	Package	Marking
BSS 284	-50 V	-0.13 A	10 $\Omega$	SOT-23	SDs

Type	Ordering Code	Tape and Reel Information
BSS 284	Q62702-S299	E6327

## Maximum Ratings

Parameter	Symbol	Values	Unit
Drain source voltage	$V_{DS}$	-50	V
Drain-gate voltage $R_{GS} = 20\text{ k}\Omega$	$V_{DGR}$	-50	
Gate source voltage	$V_{GS}$	$\pm 20$	
Continuous drain current $T_A = 30\text{ }^\circ\text{C}$	$I_D$	-0.13	A
DC drain current, pulsed $T_A = 25\text{ }^\circ\text{C}$	$I_{Dpuls}$	-0.52	
Power dissipation $T_A = 25\text{ }^\circ\text{C}$	$P_{tot}$	0.36	W

## Maximum Ratings

Parameter	Symbol	Values	Unit
Chip or operating temperature	$T_j$	-55 ... + 150	°C
Storage temperature	$T_{stg}$	-55 ... + 150	
Thermal resistance, chip to ambient air <sup>1)</sup>	$R_{thJA}$	≤ 350	K/W
Thermal resistance, chip-substrate- reverse side <sup>1)</sup>	$R_{thJSR}$	≤ 285	
DIN humidity category, DIN 40 040		E	
IEC climatic category, DIN IEC 68-1		55 / 150 / 56	

1) For package mounted on aluminium 15 mm x 16.7 mm x 0.7 mm

## Electrical Characteristics, at $T_j = 25^\circ\text{C}$ , unless otherwise specified

Parameter	Symbol	Values			Unit
		min.	typ.	max.	

### Static Characteristics

Drain- source breakdown voltage $V_{GS} = 0 \text{ V}$ , $I_D = -0.25 \text{ mA}$ , $T_j = 25 \text{ }^\circ\text{C}$	$V_{(BR)DSS}$	-50	-	-	V
Gate threshold voltage $V_{GS} = V_{DS}$ , $I_D = -1 \text{ mA}$	$V_{GS(th)}$	-0.8	-1.2	-1.6	
Zero gate voltage drain current $V_{DS} = -50 \text{ V}$ , $V_{GS} = 0 \text{ V}$ , $T_j = 25 \text{ }^\circ\text{C}$ $V_{DS} = -50 \text{ V}$ , $V_{GS} = 0 \text{ V}$ , $T_j = 125 \text{ }^\circ\text{C}$ $V_{DS} = -25 \text{ V}$ , $V_{GS} = 0 \text{ V}$ , $T_j = 25 \text{ }^\circ\text{C}$	$I_{DSS}$	-	-0.1 -2 -	-1 -60 -0.1	μA
Gate-source leakage current $V_{GS} = -20 \text{ V}$ , $V_{DS} = 0 \text{ V}$	$I_{GSS}$	-	-1	-10	
Drain-Source on-state resistance $V_{GS} = -10 \text{ V}$ , $I_D = -0.13 \text{ A}$	$R_{DS(on)}$	-	5	10	Ω

### Electrical Characteristics, at $T_j = 25^\circ\text{C}$ , unless otherwise specified

Parameter	Symbol	Values			Unit
		min.	typ.	max.	

### Dynamic Characteristics

Transconductance $V_{DS} \geq 2 * I_D * R_{DS(on)max}$ , $I_D = -0.13 \text{ A}$	$g_{fs}$	0.05	0.08	-	S
Input capacitance $V_{GS} = 0 \text{ V}$ , $V_{DS} = -25 \text{ V}$ , $f = 1 \text{ MHz}$	$C_{iss}$	-	30	40	pF
Output capacitance $V_{GS} = 0 \text{ V}$ , $V_{DS} = -25 \text{ V}$ , $f = 1 \text{ MHz}$	$C_{oss}$	-	17	25	
Reverse transfer capacitance $V_{GS} = 0 \text{ V}$ , $V_{DS} = -25 \text{ V}$ , $f = 1 \text{ MHz}$	$C_{rss}$	-	8	12	
Turn-on delay time $V_{DD} = -30 \text{ V}$ , $V_{GS} = -10 \text{ V}$ , $I_D = -0.27 \text{ A}$ $R_{GS} = 50 \Omega$	$t_{d(on)}$	-	7	10	ns
Rise time $V_{DD} = -30 \text{ V}$ , $V_{GS} = -10 \text{ V}$ , $I_D = -0.27 \text{ A}$ $R_{GS} = 50 \Omega$	$t_r$	-	12	18	
Turn-off delay time $V_{DD} = -30 \text{ V}$ , $V_{GS} = -10 \text{ V}$ , $I_D = -0.27 \text{ A}$ $R_{GS} = 50 \Omega$	$t_{d(off)}$	-	10	13	
Fall time $V_{DD} = -30 \text{ V}$ , $V_{GS} = -10 \text{ V}$ , $I_D = -0.27 \text{ A}$ $R_{GS} = 50 \Omega$	$t_f$	-	20	27	

**Electrical Characteristics**, at  $T_j = 25^\circ\text{C}$ , unless otherwise specified

Parameter	Symbol	Values			Unit
		min.	typ.	max.	

**Reverse Diode**

Inverse diode continuous forward current $T_A = 25^\circ\text{C}$	$I_S$	-	-	-0.13	A
Inverse diode direct current, pulsed $T_A = 25^\circ\text{C}$	$I_{SM}$	-	-	-0.52	
Inverse diode forward voltage $V_{GS} = 0\text{ V}$ , $I_F = -0.26\text{ A}$ , $T_j = 25^\circ\text{C}$	$V_{SD}$	-	-0.9	-1.2	V

### Power dissipation

$$P_{\text{tot}} = f(T_A)$$

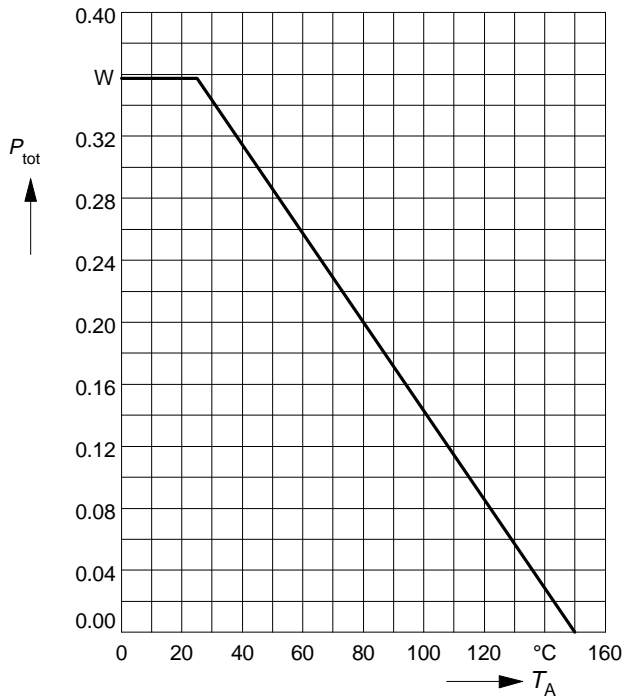

### Drain current

$$I_D = f(T_A)$$

parameter:  $V_{GS} \geq -10$  V

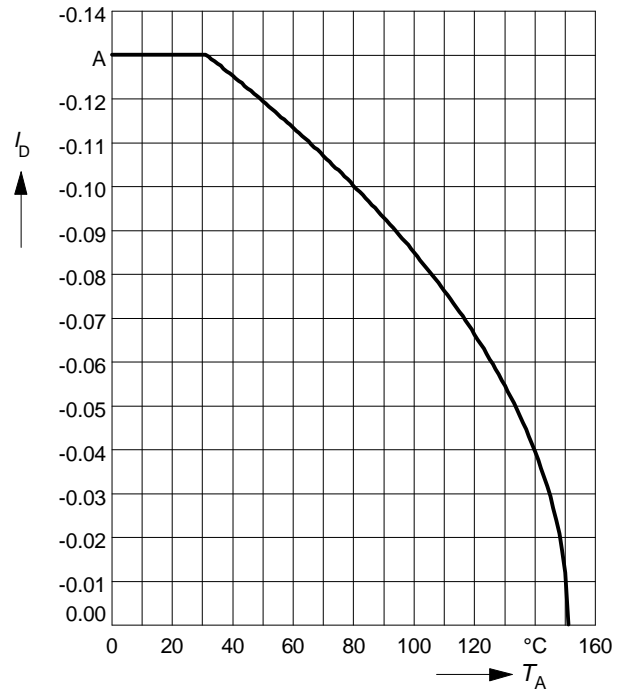

### Safe operating area $I_D = f(V_{DS})$

parameter:  $D = 0.01$ ,  $T_C = 25^\circ\text{C}$

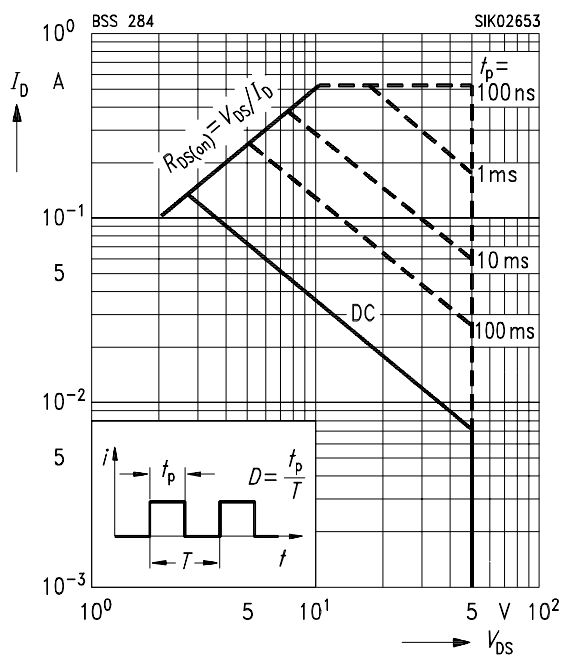

### Drain-source breakdown voltage

$$V_{(BR)DSS} = f(T_j)$$

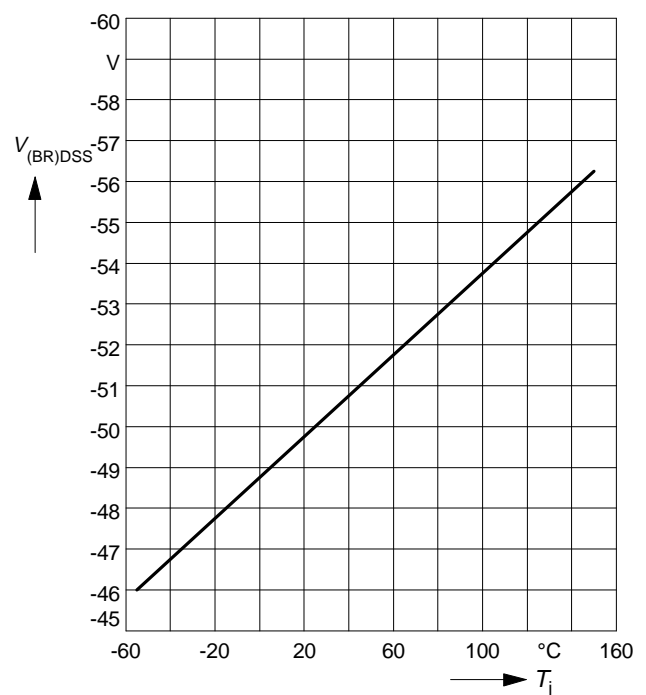

### Typ. output characteristics

$$I_D = f(V_{DS})$$

parameter:  $t_p = 80 \mu s$ ,  $T_j = 25^\circ C$

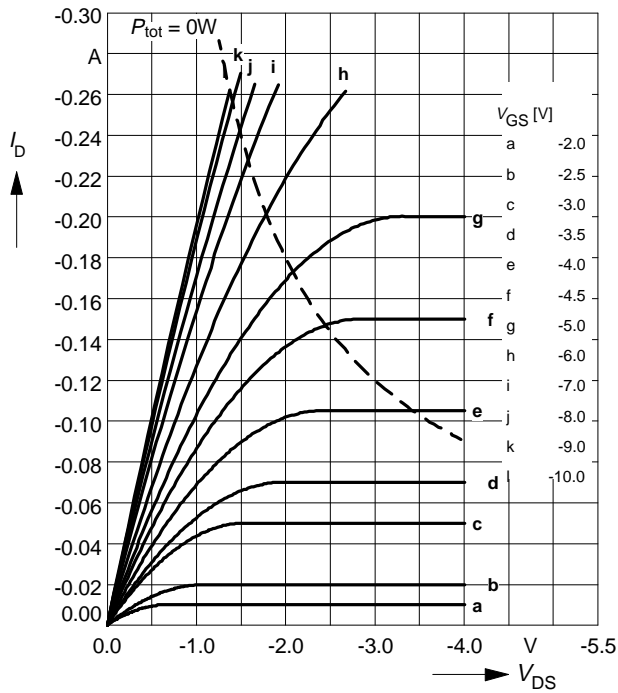

### Typ. drain-source on-resistance

$$R_{DS(on)} = f(I_D)$$

parameter:  $t_p = 80 \mu s$ ,  $T_j = 25^\circ C$

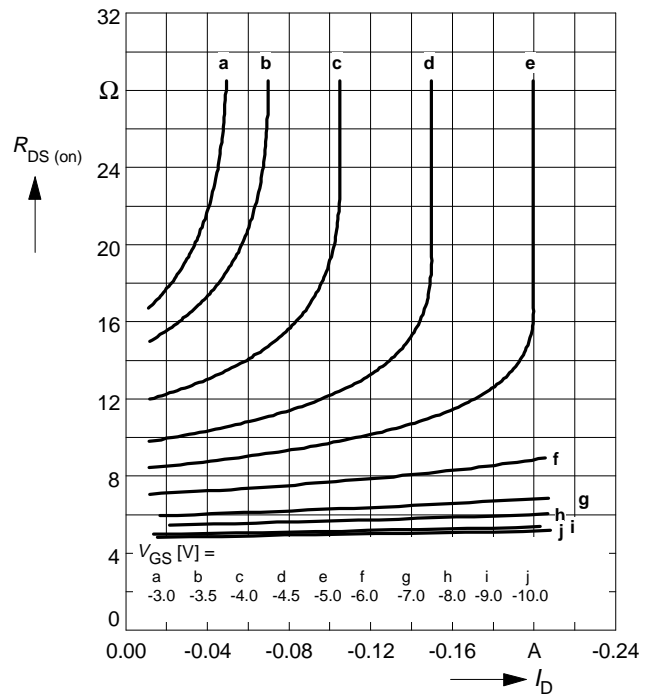

### Typ. transfer characteristics $I_D = f(V_{GS})$

parameter:  $t_p = 80 \mu s$

$$V_{DS} \geq 2 \times I_D \times R_{DS(on)max}$$

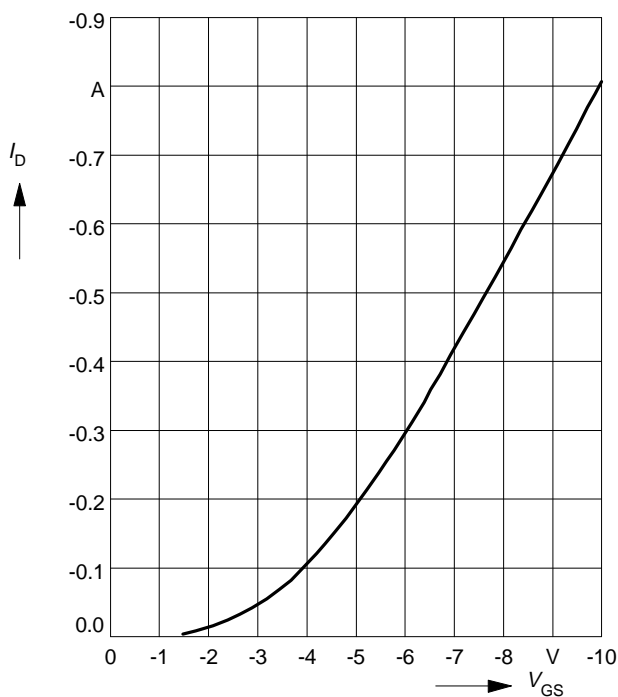

### Typ. forward transconductance $g_{fs} = f(I_D)$

parameter:  $t_p = 80 \mu s$ ,

$$V_{DS} \geq 2 \times I_D \times R_{DS(on)max}$$

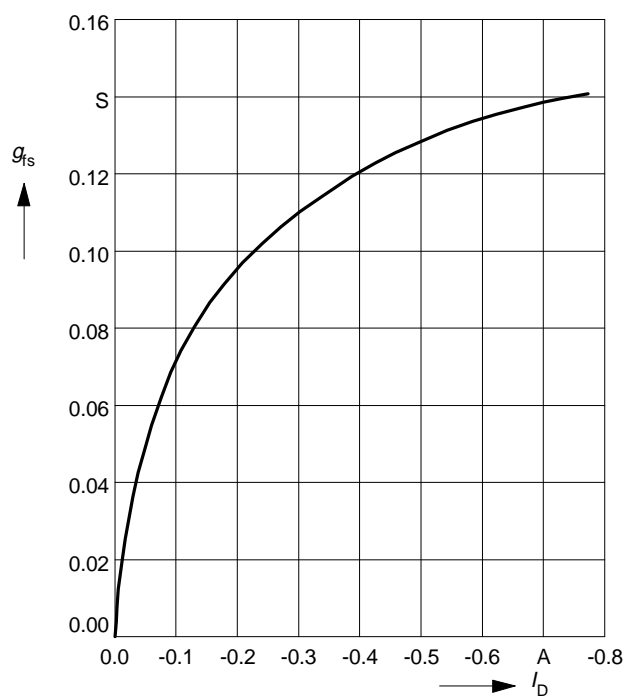

### Drain-source on-resistance

$$R_{DS(on)} = f(T_j)$$

parameter:  $I_D = -0.13$  A,  $V_{GS} = -10$  V

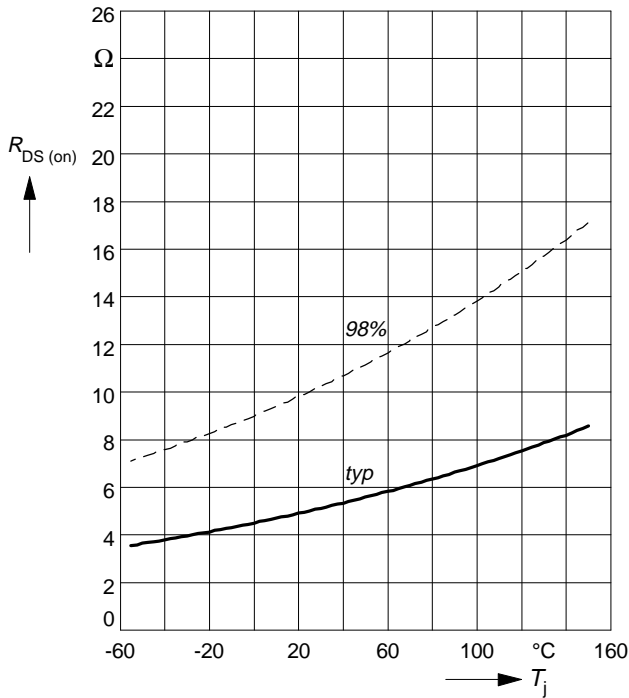

### Gate threshold voltage

$$V_{GS(th)} = f(T_j)$$

parameter:  $V_{GS} = V_{DS}$ ,  $I_D = -1$  mA

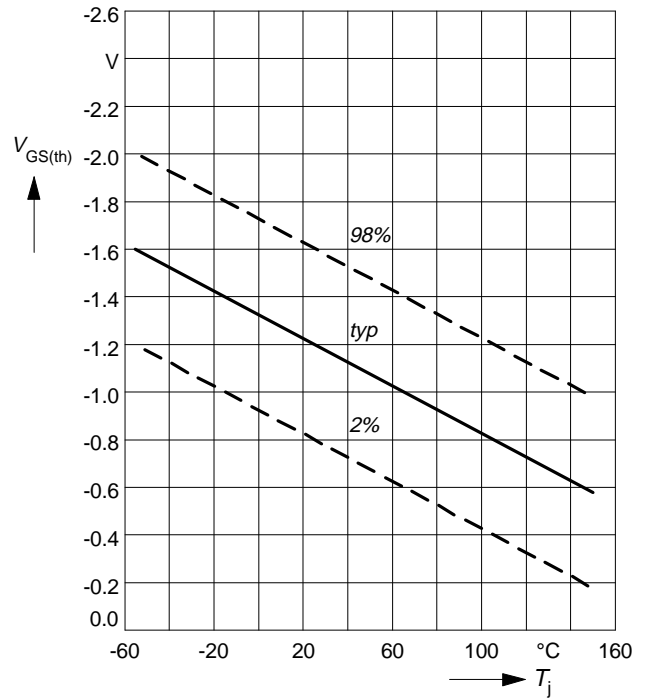

### Typ. capacitances

$$C = f(V_{DS})$$

parameter:  $V_{GS}=0$  V,  $f = 1$  MHz

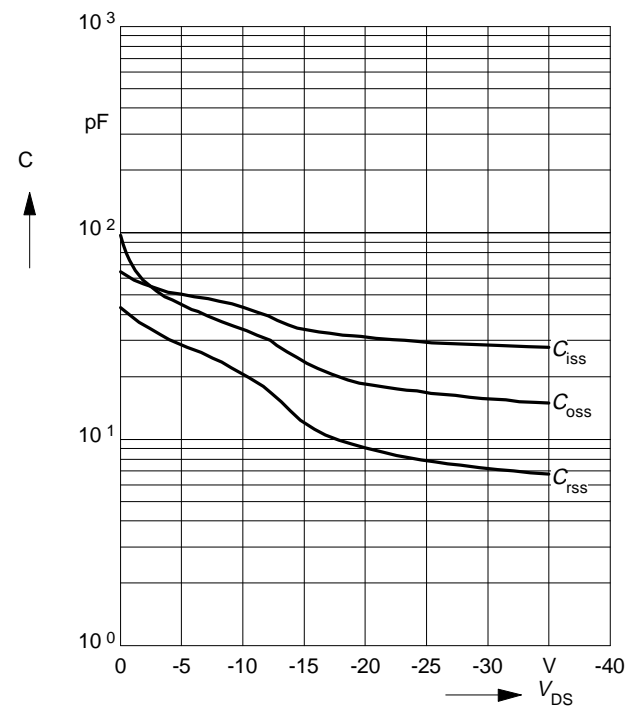

### Forward characteristics of reverse diode

$$I_F = f(V_{SD})$$

parameter:  $T_j, t_p = 80$  μs

