

FULLY PROTECTED H-BRIDGE FOR D.C. MOTOR

Features

- Over temperature shutdown
- Over current shutdown
- Inrush current limited by Soft-Start sequence
- E.S.D protection
- Status feedback
- Sleep mode for direct battery connection
- Braking/non-braking operation

Description

The IR 3220 is a Fully Protected Dual High Side Switch I.C. With two additional Low Side switches (e.g. IRF7474 - available 01/01), the IR 3220 drives and controls the whole H bridge topology. It provides shoot-through protection for each leg, H bridge logic control, soft-start sequence and over-current /over-temp. protections. The signals IN1 and IN2 select the operation modes and the PWM Soft-Start sequence cycles the corresponding active low side switch in order to limit the motor inrush current. By using the recommended part number and the proper cooling, the inner High Side IPS protects the whole H bridge function. The Soft-Start sequence is programmed by an RC time constant and reset itself automatically.

Typical Connection

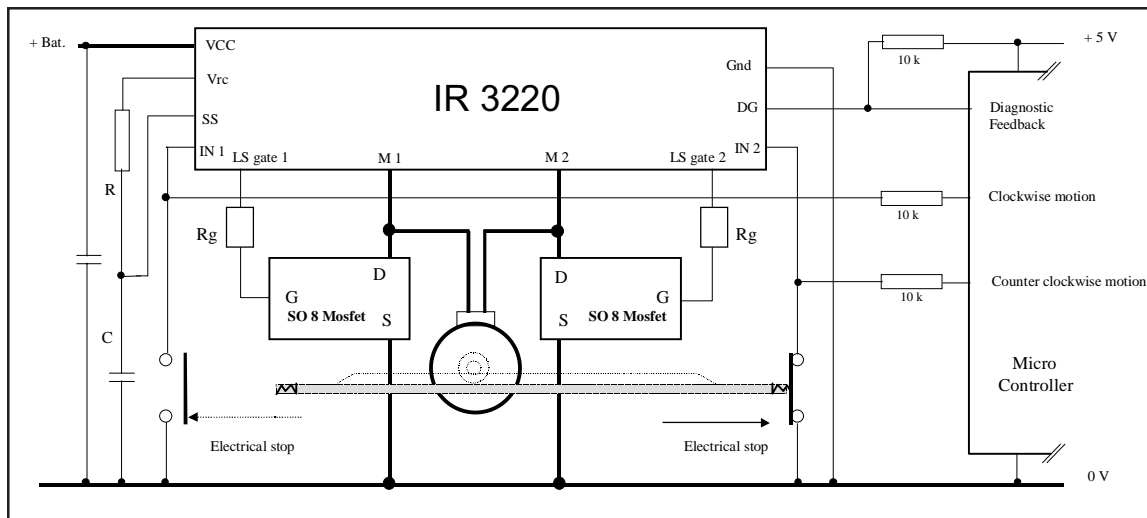

Product Summary

$R_{ds(on)}$	12m Ω max.
$V_{cc.op.}$	5.5 to 35V
$I_{cont.}$ ($T_a = 85^{\circ}C$)	7.0A
$I_{shutdown}$	30A
Oper. Freq.	20 kHz

Packages

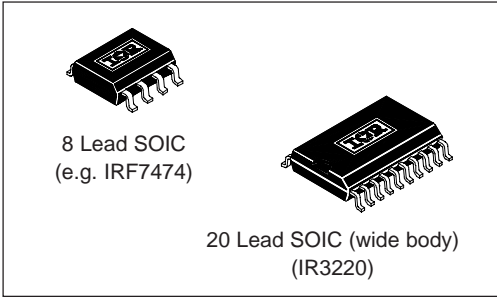

Absolute Maximum Ratings

Absolute maximum ratings indicates sustained limits beyond which damage to the device may occur. All voltage parameters are referenced to Gnd lead. (T_{Ambient} = 25°C unless otherwise specified). Symbols with (2) refer to M2 output.

Symbol	Parameter	Min.	Max.	Units
V _{m1} (2)	Maximum M1 (M2) voltage (active clamp)	V _{CC} -37	V _{CC} +0.3	V
V _{in1} (2)	Maximum IN 1 (IN 2) voltage	-0.3	5.5	
V _{CC/gnd}	Maximum V _{CC} pin to GND pin voltage	0.3	50	
I _{in1} (2)	Maximum IN1 (IN 2) current	-1	10	mA
V _{g1} (2)	Maximum Gate 1 (Gate 2) voltage	-0.3	7.5	V
V _{SS}	Maximum SS voltage	-0.3	5.5	
V _{rc}	Maximum V _{rc} voltage	-0.3	5.5	
I _{rc}	Maximum output current of the V _{rc} pin	—	1	mA
V _{dg}	Maximum diagnostic output voltage	-0.3	5.5	V
I _{dg}	Maximum diagnostic output current	-1	10	mA
I _{sd cont.}	Diode max. permanent current (R _{th} =60°C/W) (1) (R _{th} =45°C/W) (1)	—	3.0	A
I _{sd pulsed}	Diode max. pulsed current (1)	—	15	
ESD 1	Electrostatic discharge (human body model C=100pF, R=1500Ω)	—	tbd	V
ESD 2	Electrostatic discharge (machine model C=200pF, R=0Ω, L=10μH)	—	tbd	
PD	Maximum power dissipation (R _{th} = 60°C/W)	—	1.5	W
T _{J max.}	Max. storage & operating junction temperature	-40	+150	°C
T _L	Lead temperature (soldering 10 seconds)	—	300	
V _{CC max.}	Maximum V _{CC} voltage	—	37	V
I _{g1} (2) max.	Maximum gate current (T _{on} < 5μS)	—	100	mA
I _{g1} (2) avg.	Maximum average gate current	—	10	

(1) Limited by junction temperature (pulsed current limited also by internal wiring)

Thermal Characteristics

Symbol	Parameter	Typ.	Max.	Units
R _{th 1}	Thermal junction to amb. resistance (std footprint 1 MOS on)	60	—	°C/W
R _{th 2}	Thermal junction to ambient resistance (1" sq. footprint 1 MOS on)	45	—	

Recommended Operating Conditions

These values are given for a quick design. For operation outside these conditions, please consult the application notes.

Symbol	Parameter	Min.	Max.	Units
V _{cc}	Continuous V _{cc} voltage (2)	8	18	V
V _{in1} (2)	High level IN 1 (IN 2) input voltage	4	5.5	
V _{in1} (2)	Low level IN 1 (IN 2) input voltage	-0.3	0.9	
I _{out} Ta=85°C	Continuous output current (R _{th/amb} < 5 °C/W, T _j = 125°C)	—	7.0	A
I _{out} Ta=105°C	Continuous output current (R _{th/amb} < 5 °C/W, T _j = 125°C)	—	4.5	
R _{in}	Recommended resistor in series with IN pin	10	20	kΩ
R _{dg}	Recommended pull-up resistor on DG pin	1	20	
R	Soft-Start resistor	5.0	100	
C	Soft-Start capacitor	0.1	3.3	μF
R _{gate}	Recommended gate resistor for Low Side Switch	0	50	Ω

Static Electrical Characteristics

(T_j = 25°C, V_{CC} = 14V unless otherwise specified.)

Symbol	Parameter	Min.	Typ.	Max.	Units	Test Conditions
R _{ds1 on}	ON state resistance T _j = 25°C	—	9	12	mΩ	V _{in1,2} = 5V, I _{m1,2} = 5A
R _{ds2 on}	ON state resistance T _j = 150°C	—	16	22		
V _{cc oper.}	Functional voltage range	5.5	—	35	V	I _d = 10mA see Figs.1,2 I _d = 5A, V _{in1,2} = 0V
V _{clamp1} (2)	V _{cc} to M1 (M2) clamp voltage	37	40	48		
V _{f1} (2)	Body diode 1 (2) forward voltage	—	0.9	—	μA	V _{m1, 2} = 0V; T _j = 25°C V _{in1(2)} = 0V
I _{m1} (2) leakage	M1 (M2) output leakage current	—	10	50		
I _{cc off}	Supply current when off (sleep mode)	—	10	50	mA	V _{in1} = 5V
I _{cc on}	Supply current when on	—	8	—		
V _{dgl}	Low level diagnostic output voltage	—	0.3	—	V	I _{dg} = 1.6mA
I _{dg leakage}	Diagnostic output leakage current	—	—	10	μA	V _{dg} = 5.5V
V _{ih1} (2) th.	IN1 (IN2) high threshold voltage	—	2.6	—	V	
V _{il1} (2) th.	IN1 (IN2) low threshold voltage	—	2.0	—		
I _{in1} (2)	ON state IN1 (IN2) positive current	—	25	—	μA	V _{in1, 2} = 5V
V _{ccuv}	V _{cc} UVLO positive going threshold	—	5	—	V	
V _{ccuv-}	V _{cc} UVLO negative going threshold	—	4	—		
V _{ss+}	SS high level threshold	—	4	—		
V _{ss-}	SS low level threshold	—	1	—		
I _{ss leakage}	SS pin leakage current	—	0.1	10	μA	

Switching Electrical Characteristics

V_{CC} = 14V, Resistive Load = 3.0Ω, T_j = 25°C, (unless otherwise specified).

Symbol	Parameter	Min.	Typ.	Max.	Units	Test Conditions
T _{don}	Turn-on delay time	—	5	—	μs	see figure 3
T _{r1}	Rise time to V _{out} = V _{CC} - 5V	—	4	—		
T _{r2}	Rise time from the end of T _{r1} to V _{out} = 90% of V _{CC}	—	65	—		
dV/dt (on)	Turn ON dV/dt	—	3	—	V/μs	
T _{doff}	Turn-off delay time	—	65	—	μs	see figure 4
T _f	Fall time to V _{out} = 10% of V _{CC}	—	8	—		
dV/dt (off)	Turn OFF dV/dt	—	5	—	V/μs	
IN1 (2) max. freq.	Max. frequency on IN1 (IN2)	—	500	—	Hz	
Soft-Start freq.	Soft-Start oscillator frequency	15	20	30	kHz	
I _{g1} (2) min.	Min. Gate 1 (Gate 2) current	50	—	—	mA	low side driver
Trd	Min. IN1 (2) OFF time to reset SS	2.0	—	—	ms	C=3.0μF, IN1 = IN2
V _{g1}	Gate 1 (gate 2) voltage	—	7	—	V	

Protection Characteristics

Symbol	Parameter	Min.	Typ.	Max.	Units	Test Conditions
T _{sd}	Over-temperature threshold	—	165	—	°C	See figure 2
I _{sd}	Over-current threshold	25	30	35	A	See figure 2
T _{reset}	Minimum time to reset protections	—	100	—	μs	IN1 = IN2 = 0V

Note: The low side switches present sufficient cooling capability in order to have the whole H Bridge function protected by the IR3220 inner temperature sensor.

Functional Block Diagram

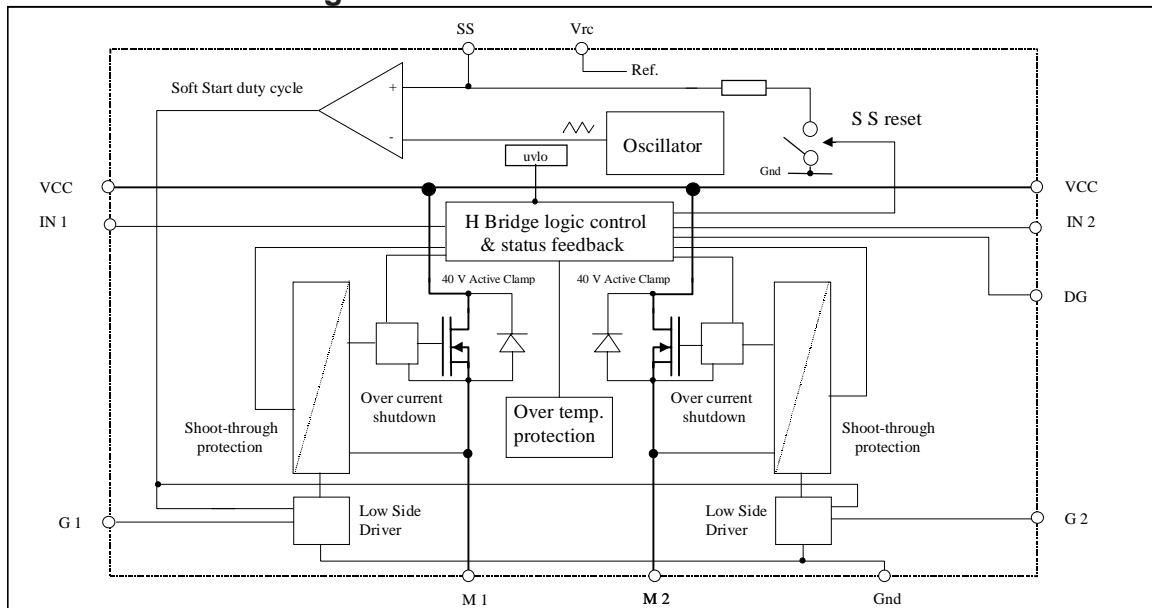

Truth Table

IN1	IN2	MODES	DG	HS1	LSS1	HS2	LSS2	SS reset
L	L	Stand-by with braking - sleep mode**	H	OFF	ON	OFF	ON	ON
L	H	Foward rotation (normal operation)	H	OFF	ON*	ON	OFF	OFF
L	H	Foward rotation (protection triigered)	L	OFF	ON*	OFF	OFF	OFF
H	L	Reverse rotation (normal operation)	H	ON	OFF	OFF	ON*	OFF
H	L	Reverse rotation (protection triggered)	L	OFF	OFF	OFF	ON*	OFF
H	H	Stand-by without braking	H	OFF	OFF	OFF	OFF	ON

* During Soft-start sequence, the low side part is switching.

** Protections are reset in this mode

Lead Definitions

Vcc	Positive power supply	IN1	Logic input 1 (Leg 1 Cdt. / mode)
M1	Motor 1 output (high side source - leg 1)	IN2	Logic input 2 (Leg 2 Cdt. / mode)
M2	Motor 2 output (high side source - leg 2)	Dg	Diagnostic output (open drain)
G1	Gate 1 drive output (low side gate - leg 1)	Vrc	Voltage ref. output (soft-start RC)
G2	Gate 2 drive output (low side gate - leg 2)	SS	RC soft-start input (the voltage on this input drives the switching duty cycle)
Gnd	Power supply return		

Recommended Low Side MOSFET

e.g. IRF7413	OR	a 10mΩ /40V - SOIC 8 packaged Power Mosfet
--------------	----	--

Lead Assignments

<p>Vcc Vcc m1 m1 m1 nc g1 Gnd In1 Vrc</p> <p>Vcc Vcc m2 m2 m2 nc g2 In2 Dg SS</p> <p>20 Lead - SOIC (wide body)</p>	<p>D D D D</p> <p>S S S G</p> <p>8 Lead - SOIC</p>
IR3220	e.g. IRF7474
Part Number	

Soft-start sequence

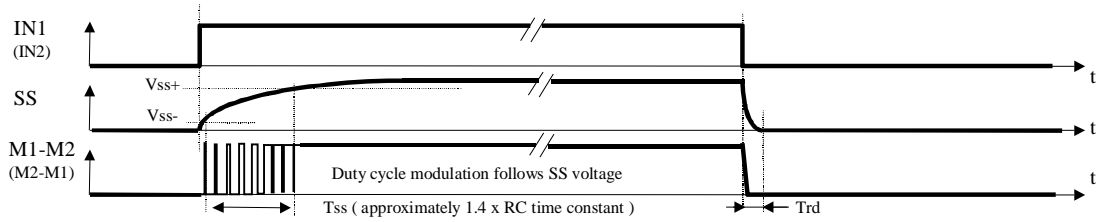

Permanent Switching Operation

(without external RC time constant)

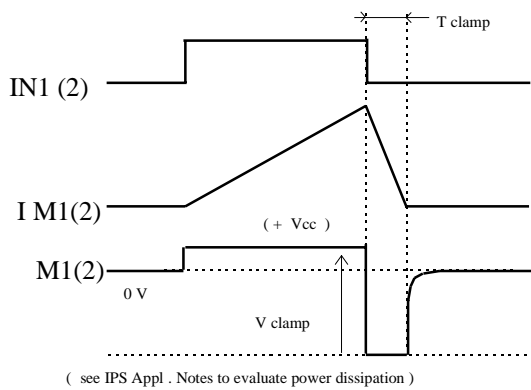
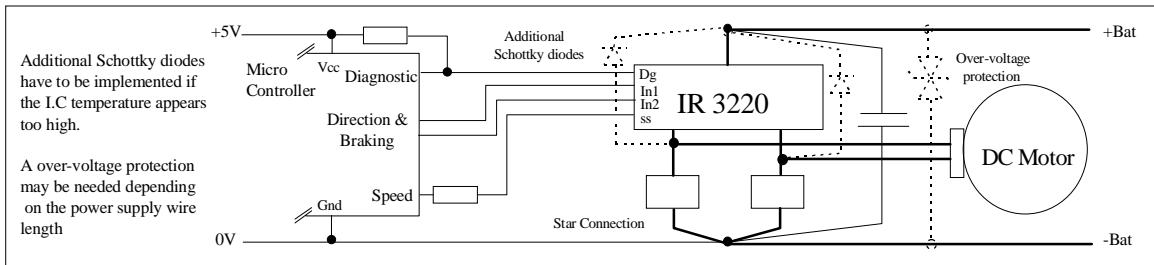

Figure 1 - Active clamp waveforms

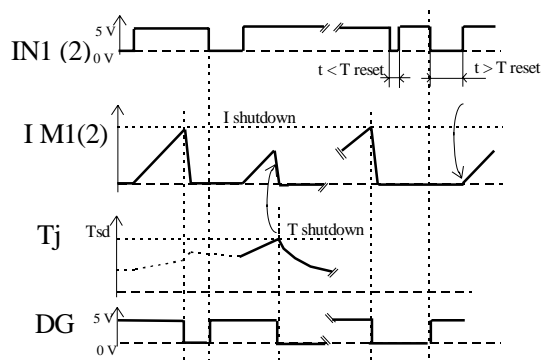

Figure 2 - Protection Timing diagram

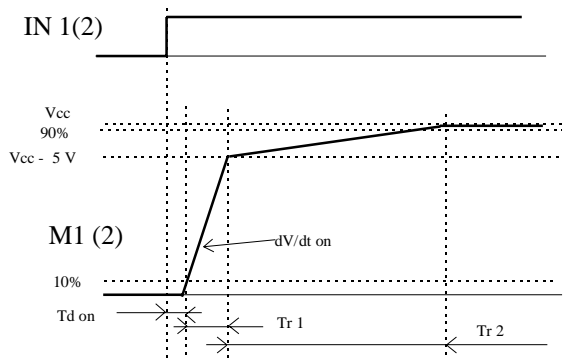

Figure 3 - Switching Time Definitions (turn-on)

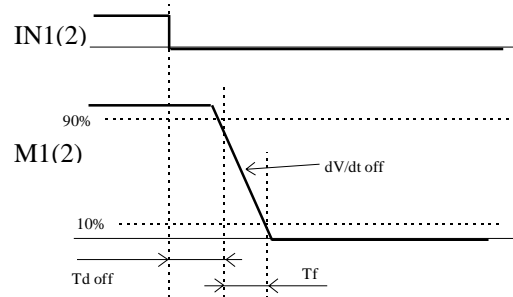

Figure 7 - Switching Time Definitions (turn-off)

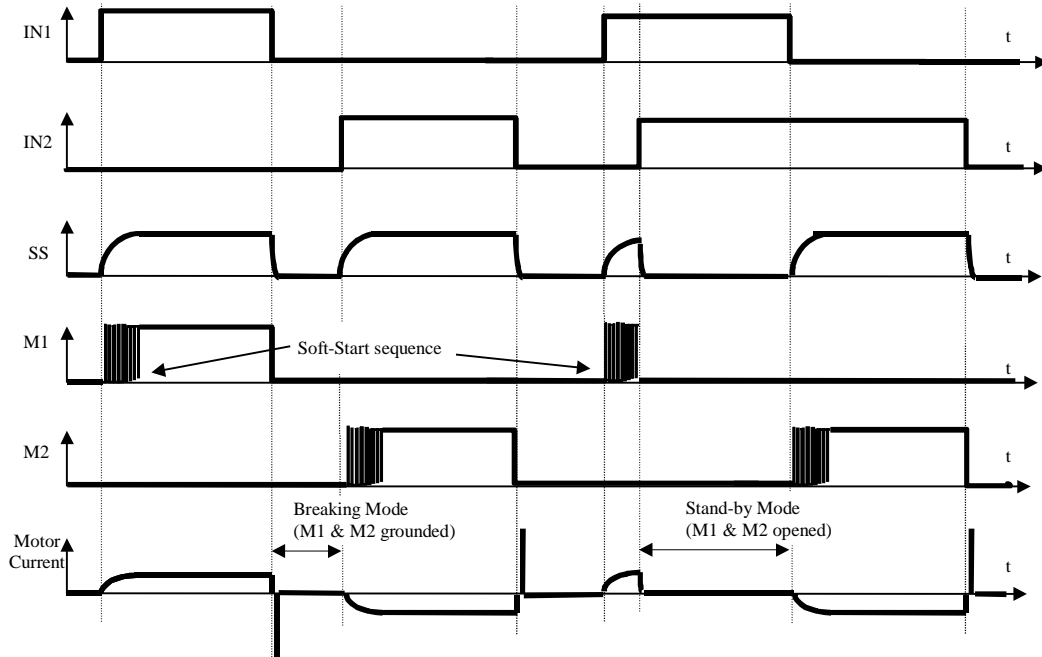

Figure 5 - IN1 (2) & M1 (2) Timing Diagrams

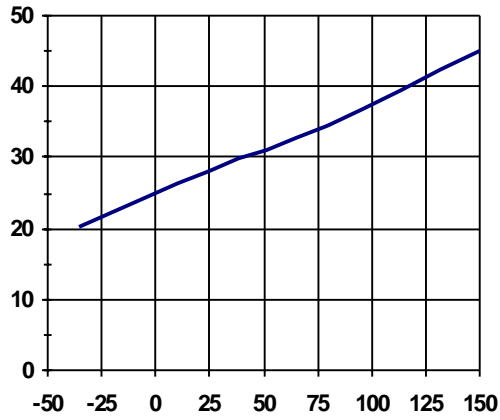

Figure 6 - IN1 (2) current (µA) vs T_j (°C)

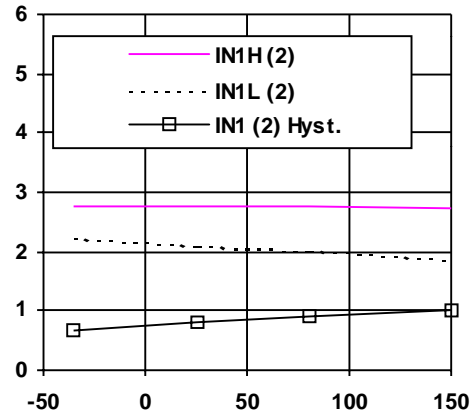

Figure 7 - IN1 (2) thresholds (V) vs T_j (°C)

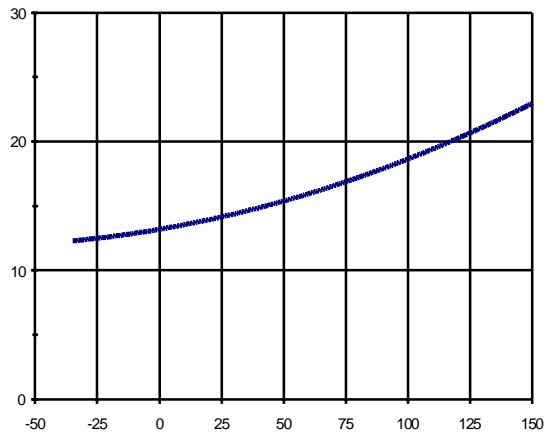

Figure 8 - R_{dson} (mΩ) vs T_j (°C)

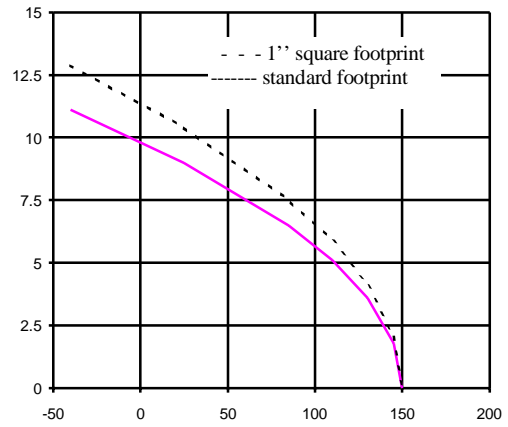

Figure 9 - Max. Cont. current (A) vs Amb. Temp. (°C)

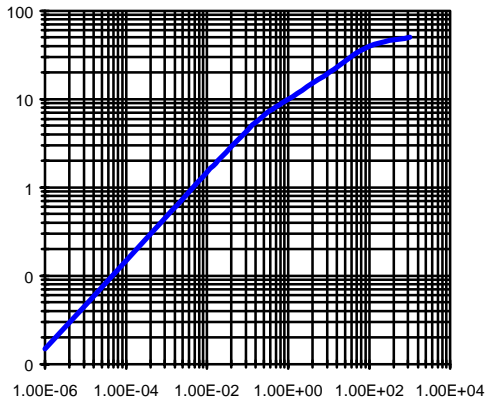

Figure 10 - Transient Thermal Imped. (°C/W) vs Time (s)

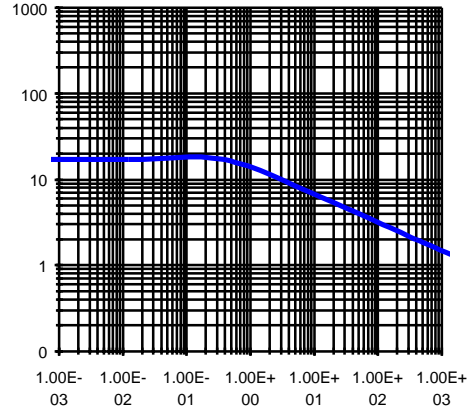

Figure 11 - Iclamp (A) vs Power Supply Wire Inductance (mH - single pulse)

Case Outline - 8 Lead SOIC

DIM	INCHES		MILLIMETERS	
	MIN	MAX	MIN	MAX
A	.0532	.0688	1.35	1.75
A1	.0040	.0098	0.10	0.25
b	.014	.018	0.36	0.46
c	.0075	.0098	0.19	0.25
D	.189	.196	4.80	4.98
E	.150	.157	3.81	3.99
e	.050	BASIC	1.27	BASIC
e1	.025	BASIC	0.635	BASIC
H	.2284	.2440	5.80	6.20
K	.011	.019	0.28	0.48
L	.016	.050	0.41	1.27
y	0°	8°	0°	8°

NOTES:

1. DIMENSIONING & TOLERANCING PER ASME Y14.5M-1994.
2. CONTROLLING DIMENSION: MILLIMETER.
3. DIMENSIONS ARE SHOWN IN MILLIMETERS [INCHES].
4. OUTLINE CONFORMS TO JEDEC OUTLINE MS-012AA.

⑤ DIMENSION DOES NOT INCLUDE MOLD PROTRUSIONS. MOLD PROTRUSIONS NOT TO EXCEED 0.25 [.006].

⑥ DIMENSION IS THE LENGTH OF LEAD FOR SOLDERING TO A SUBSTRATE.

(MS-012AA) 01-0021 09

Case Outline

