

# Surface Mount Microwave Schottky Detector Diodes

## Technical Data

### HSMS-2850 Series HSMS-2860 Series

#### Features

- Surface Mount SOT-23/  
SOT-143 Package
- High Detection Sensitivity:  
up to 50 mV/μW at 915 MHz  
up to 35 mV/μW at 2.45 GHz  
up to 25 mV/μW at 5.80 GHz
- Low Flicker Noise:  
-162 dBV/Hz at 100 Hz
- Low FIT (Failure in Time)  
Rate\*
- Tape and Reel Options  
Available

\* For more information see the Surface Mount Schottky Reliability Data Sheet.

#### HSMS-2860 Package Lead Code Identification

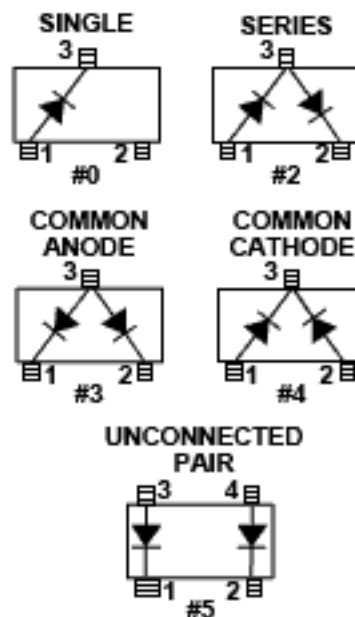

#### HSMS-2850 Package Lead Code Identification

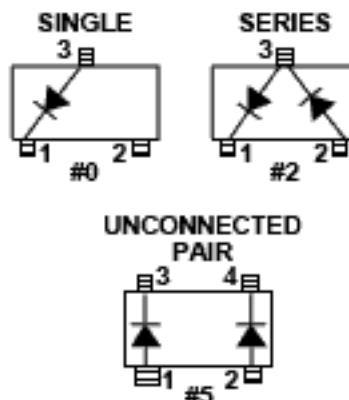

#### Description

Hewlett-Packard's HSMS-2850 family of zero bias Schottky detector diodes and the HSMS-2860 family of DC biased detector diodes have been designed and optimized for use from 915 MHz to 5.8 GHz. They are ideal for RFID and RF Tag applications requiring small and large signal detection, modulation, RF to DC conversion or voltage doubling.

Available in various package configurations, these two families of detector diodes provide low cost solutions to a wide variety of design problems. Hewlett-Packard's manufacturing techniques assure that when two diodes are mounted into a single SOT-23 or SOT-143 package, they are taken from adjacent sites on the wafer, assuring the highest possible degree of match.

**DC Electrical Specifications,  $T_A = +25^\circ\text{C}$ , Single Diode**

Part Number HSMS-	Package Marking Code <sup>[1]</sup>	Lead Code	Configuration	Maximum Forward Voltage $V_F$ (mV)		Typical Capacitance $C_T$ (pF)
				150	250	
2850 2852 2855	P0 P2 P5	0 2 5	Single Series Pair <sup>[2,3]</sup> Unconnected Pair <sup>[2,3]</sup>			0.30
2860 2862 2863 2864 2865	T0 T2 T3 T4 T5	0 2 3 4 5	Single Series Pair <sup>[2,3]</sup> Common Anode <sup>[2,3]</sup> Common Cathode <sup>[2,3]</sup> Unconnected Pair <sup>[2,3]</sup>	250	350	0.30
Test Conditions				$I_F = 0.1 \text{ mA}$	$I_F = 1.0 \text{ mA}$	$V_R = -0.5 \text{ V to } -1.0 \text{ V}$ $f = 1 \text{ MHz}$

**Notes:**

1. Package marking code is in white.
2.  $\Delta V_F$  for diodes in pairs is 15.0 mV maximum at 1.0 mA.
3.  $\Delta C_T$  for diodes in pairs is 0.05 pF maximum at  $-0.5 \text{ V}$ .

**RF Electrical Specifications,  $T_A = +25^\circ\text{C}$ , Single Diode**

Part Number HSMS-	Typical Tangential Sensitivity TSS (dBm) @ $f =$			Typical Voltage Sensitivity $\gamma$ (mV/ $\mu\text{W}$ ) @ $f =$			Typical Video Resistance $R_V$ (K $\Omega$ )
	915 MHz	2.45 GHz	5.8 GHz	915 MHz	2.45 GHz	5.8 GHz	
2850 2852 2855	-57	-56	-55	40	30	22	8.0
Test Conditions	Video Bandwidth = 2 MHz Zero Bias			Power in = -40 dBm $R_L = 100 \text{ K}\Omega$ , Zero Bias			
2860 2862 2863 2864 2865	-57	-56	-55	50	35	25	5.0
Test Conditions	Video Bandwidth = 2 MHz $I_b = 5 \mu\text{A}$			Power in = -40 dBm $R_L = 100 \text{ K}\Omega$ , $I_b = 5 \mu\text{A}$			

### Absolute Maximum Ratings, $T_a = +25^\circ\text{C}$ , Single Diode

Symbol	Parameter	Absolute Maximum <sup>[1]</sup>	
		HSMS-285x	HSMS-286x
$P_T$	Total Device Dissipation <sup>[2]</sup>	75 mW	250 mW
$P_{IV}$	Peak Inverse Voltage	2.0 V	4.0 V
$T_J$	Junction Temperature	150°C	150°C
$T_{STG}$	Storage Temperature	-65°C to 150°C	-65°C to 150°C
$T_{OP}$	Operating Temperature	-65°C to 150°C	-65°C to 150°C

#### Notes:

1. Operation in excess of any one of these conditions may result in permanent damage to the device.
2. CW Power Dissipation at  $T_{LEAD} = +25^\circ\text{C}$ . Derate linearly to zero at maximum rated temperature.

**ESD WARNING: Handling Precautions Should Be Taken To Avoid Static Discharge.**

### Equivalent Circuit Model

HSMS-2850, HSMS-2860;  
Singles

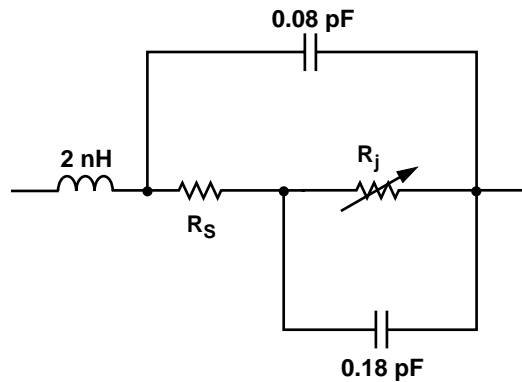

$R_S$  = series resistance (see Table of SPICE parameters)

$$R_j = \frac{8.33 \times 10^{-5} \text{ nT}}{I_b + I_s}$$

where

$I_b$  = externally applied bias current in amps

$I_s$  = saturation current (see table of SPICE parameters)

$T$  = temperature, °K

$n$  = identity factor (see table of SPICE parameters)

### SPICE Parameters

Parameter	Units	HSMS-285X	HSMS-286X
$B_V$	V	3.8	7.0
$C_{J0}$	pF	0.18	0.18
$E_G$	eV	0.69	0.69
$I_{BV}$	A	$3 \times 10E-4$	$10E-5$
$I_S$	A	$3 \times 10E-6$	$5.0 \times 10E-8$
$N$		1.06	1.08
$R_S$	$\Omega$	25	5.0
$P_B$ (VJ)	V	0.35	0.65
$P_T$ (XTI)		2	2
$M$		0.5	0.5

### Typical Parameters, Single Diode

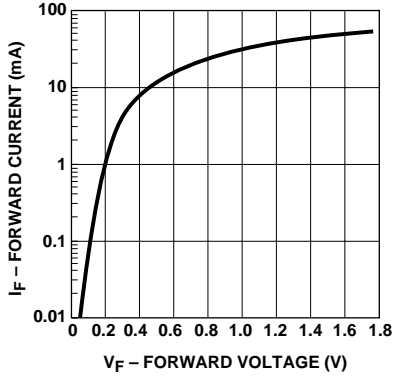

Figure 1. Typical Forward Current vs. Forward Voltage, HSMS-2850 Series.

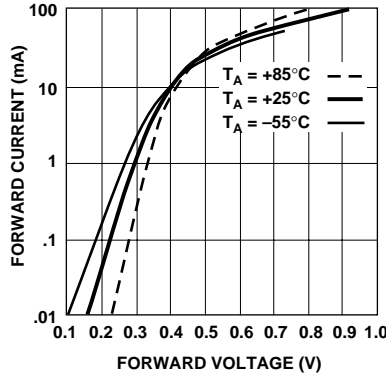

Figure 2. Typical Forward Current vs. Forward Voltage at Temperature, HSMS-2860 Series.

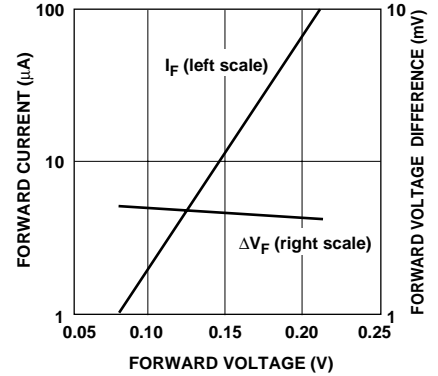

Figure 3. Typical Forward Voltage Match, HSMS-2860 Pairs.

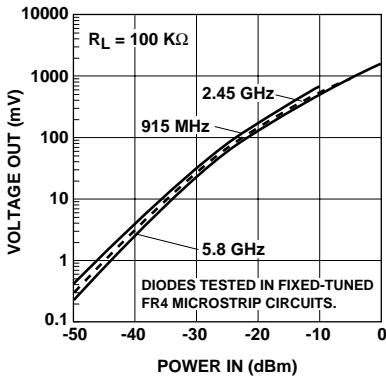

Figure 4. +25°C Output Voltage vs. Input Power, HSMS-2850 at Zero Bias, HSMS-2860 at 3  $\mu$ A Bias.

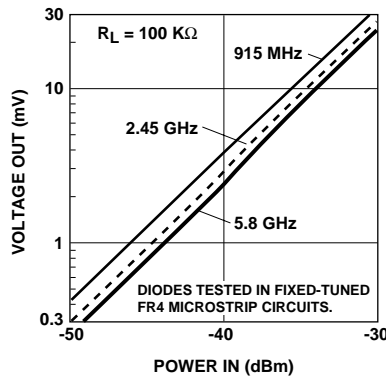

Figure 5. +25°C Expanded Output Voltage vs. Input Power. See Figure 4.

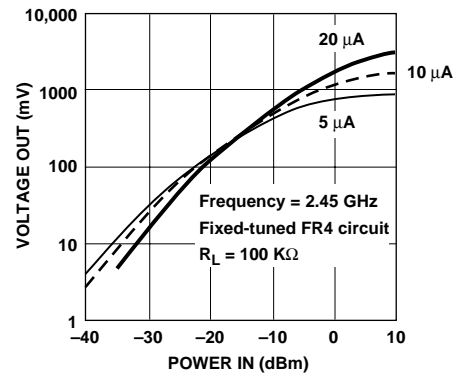

Figure 6. Dynamic Transfer Characteristic as a Function of DC Bias, HSMS-2860.

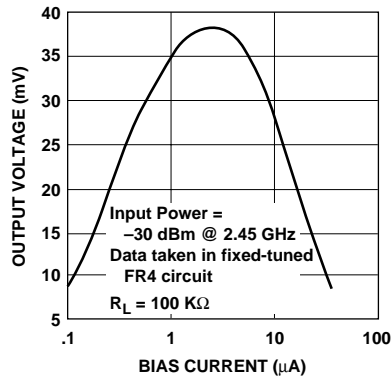

Figure 7. Voltage Sensitivity as a Function of DC Bias Current, HSMS-2860.

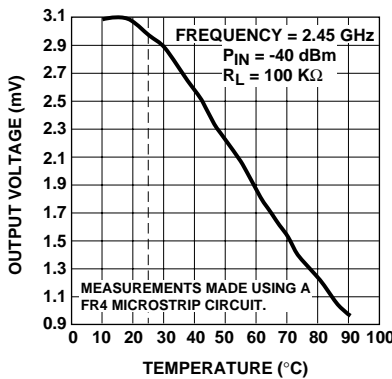

Figure 8. Output Voltage vs. Temperature, HSMS-2850 Series.

### Applications Information

See the HSMS-285A data sheet.

### Ordering Information

Specify part number followed by option. For example:

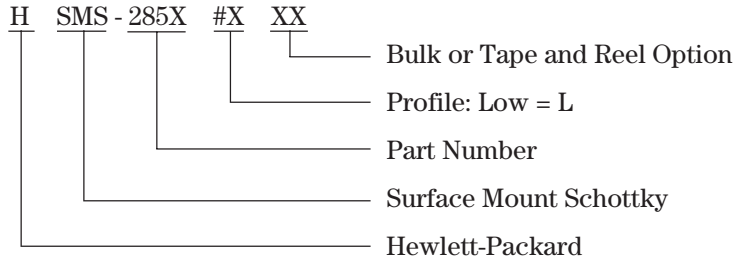

### Profile Option Descriptions

#L30 = Bulk

#L31 = 3K pc. Tape and Reel,  
Device Orientation  
Figures 9, 10

Tape and Reeling conforms to  
Electronic Industries RS-481,  
"Taping of Surface Mounted  
Components for Automated  
Placement."

### Package Dimensions Outline 23 (SOT-23)

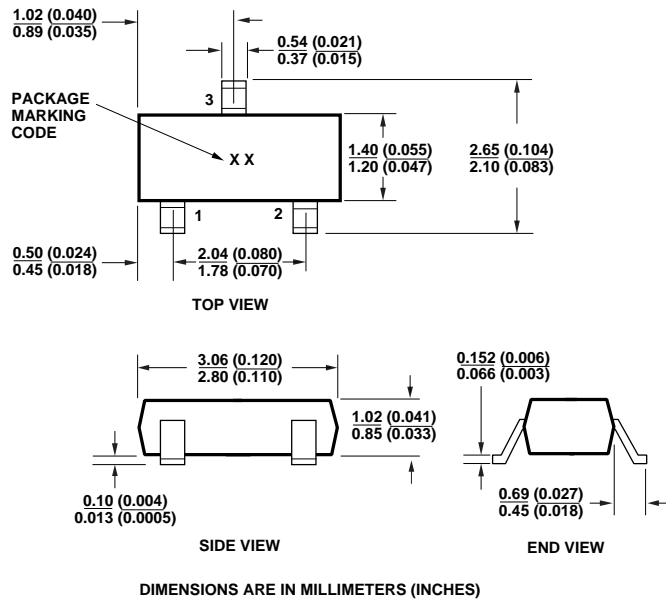

### Outline 143 (SOT-143)

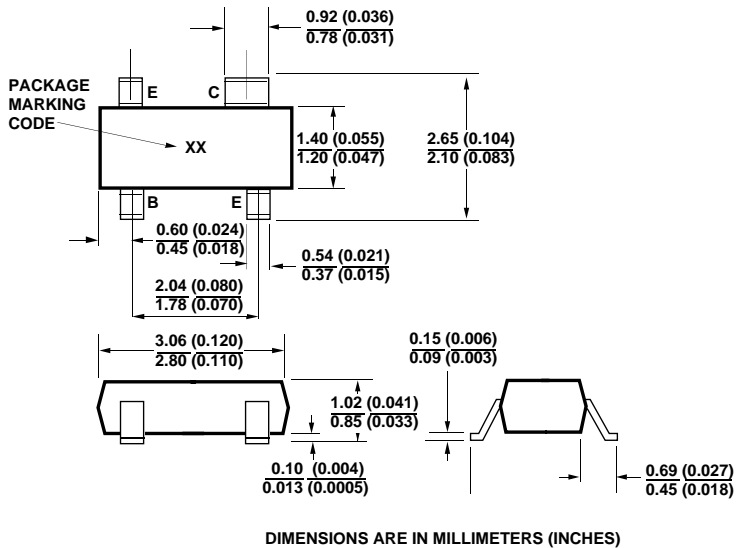

## Package Characteristics

Lead Material	Alloy 42
Lead Finish	Tin-Lead 85/15%
Max. Soldering Temp.	260°C for 5 sec.
Min. Lead Strength	2 pounds pull
Typical Package Inductance	2 nH (opposite leads)
Typical Package Capacitance	0.08 pF (opposite leads)

## Device Orientation

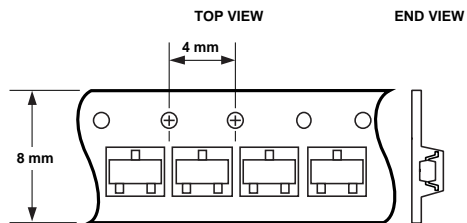
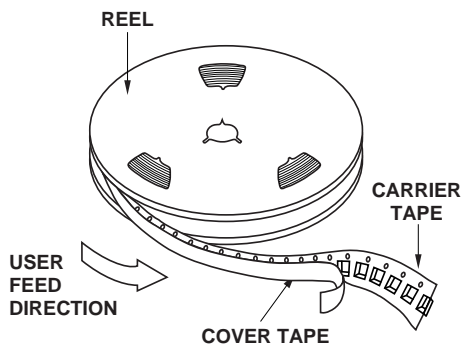

Figure 9. Option L31 for SOT-23 Packages.

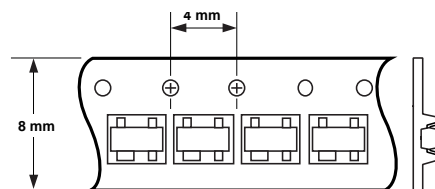

Figure 10. Option L31 for SOT-143 Packages.

[www.hp.com/go/rf](http://www.hp.com/go/rf)

For technical assistance or the location of your nearest Hewlett-Packard sales office, distributor or representative call:

**Americas/Canada:** 1-800-235-0312 or 408-654-8675

**Far East/Australasia:** Call your local HP sales office.

**Japan:** (81 3) 3335-8152

**Europe:** Call your local HP sales office.

Data subject to change.  
Copyright © 1998 Hewlett-Packard Co.

Obsoletes 5966-0928E, 5966-2939E  
Printed in U.S.A. 5966-4283E (3/98)