

FEATURES

- **ISOLATION DISTANCE:**
0.4 mm MIN.
- **HIGH ISOLATION VOLTAGE:**
BV = 2500 Vr.m.s.
- **SOP (SMALL OUT-LINE PACKAGE)**
- **HIGH SPEED SWITCHING:**
tr = 4 μs TYP, tf = 5 μs TYP
- **AVAILABLE ON TAPE AND REEL**

DESCRIPTION

NEC's PS2861-1 is an optically coupled isolator containing a GaAs light emitting diode and an NPN silicon phototransistor. This device's insulation thickness of 0.4 mm meets BSI's supplementary insulation requirements. This package is mounted in a plastic SOP (Small Out-line Package) for high density applications and has a shield effect to cut off ambient light.

APPLICATIONS

- **MODEM**
- **PROGRAMMABLE LOGIC CONTROLLERS**
- **POWER SUPPLY**

ELECTRICAL CHARACTERISTICS (TA = 25°C)

PART NUMBER			PS2861-1			
SYMBOLS	PARAMETERS	UNITS	MIN	TYP	MAX	
Diode	VF	Forward Voltage, IF = 5 mA	V	1.1	1.4	
	IR	Reverse Current, VR = 5 V	μA		5	
	Ct	Terminal Capacitance, V = 0, f = 1 MHz	pF	15		
Transistor	ICEO	Collector to Emitter Dark Current, VCE = 40 V, IF = 0 mA	nA		100	
Coupled	CTR	Current Transfer Ratio (IC/IF) ¹ , IF = 5 mA, VCE = 5 V	%	50	200	400
	VCE (sat)	Collector Saturation Voltage, IF = 10 mA, IC = 2 mA	V			0.3
	RI-O	Isolation Resistance, VI-O = 1 kVDC	Ω	10 ¹¹		
	CI-O	Isolation Capacitance, V = 0, f = 1 MHz	pF		0.4	
	tr	Rise Time ² , VCC = 5 V, IC = 2 mA, RL = 100 Ω	μs		4	
	tf	Fall Time ² , VCC = 5 V, IC = 2 mA, RL = 100 Ω	μs		5	

Notes:

- CTR Rank
K: 200 to 400%
M: 50 to 150%
L: 100 to 300%
N: 50 to 400%

2. Test Circuit for Switching Time

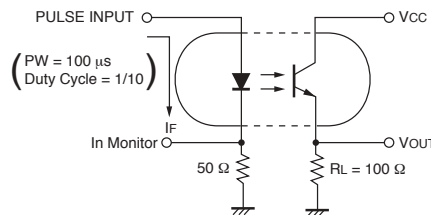

ABSOLUTE MAXIMUM RATINGS¹ (T_A = 25°C)

SYMBOLS	PARAMETERS	UNITS	RATINGS
Diode			
I _F	Forward Current (DC)	mA	50
V _R	Reverse Voltage	V	6
P _D	Power Dissipation	mW	60
ΔP _D /°C	Power Dissipation Derating	mW/°C	0.6
I _F (PEAK)	Peak Forward Current ²	A	0.5
Transistor			
V _{CEO}	Collector to Emitter Voltage	V	40
V _{ECO}	Emitter to Collector Voltage	V	5
I _C	Collector Current	mA	40
P _C	Power Dissipation	mW	120
ΔP _C /°C	Power Dissipation Derating	mW/°C	1.2
Coupled			
BV	Isolation Voltage ³	V _{r.m.s.}	2500
T _A	Operating Ambient Temp.	°C	-55 to +100
T _{STG}	Storage Temperature	°C	-55 to +150

ORDERING INFORMATION

PART NUMBER	PACKAGE	PACKING STYLE
PS2861-1	4-pin SOP	Magazine case 100 pcs
PS2861-1-F3		Embossed Tape 3500 pcs/reel
PS2861-1-F4		

Notes:

1. Operation in excess of any one of these parameters may result in permanent damage.
2. P_W = 100 μs, duty cycle = 1%.
3. AC voltage for 1 minute at T_A = 25 °C, RH = 60 % between input and output.

TYPICAL PERFORMANCE CURVES (T_A = 25°C)

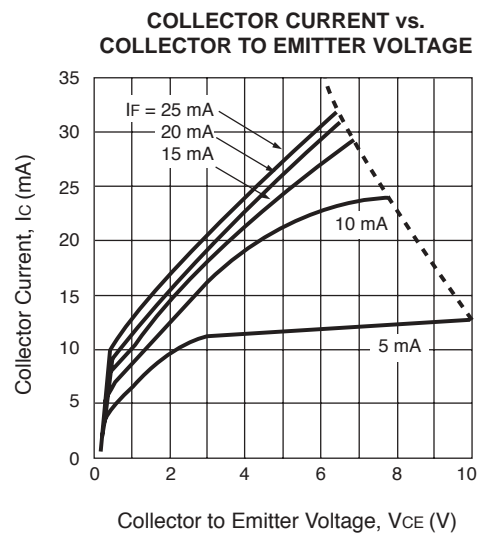
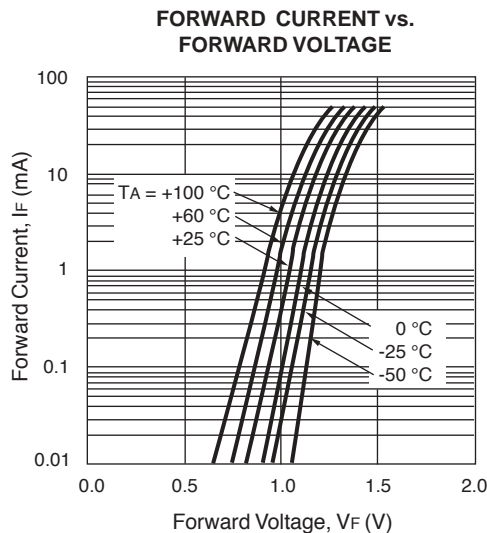
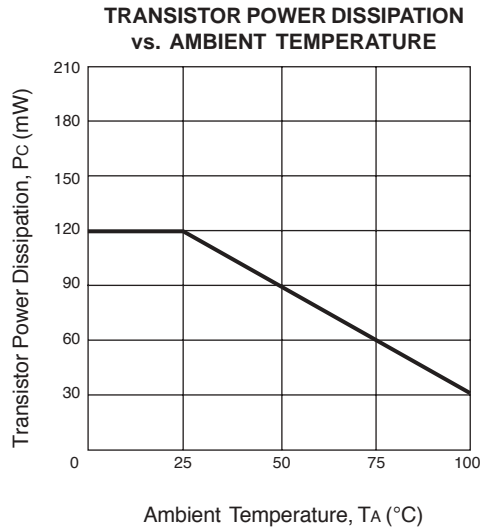
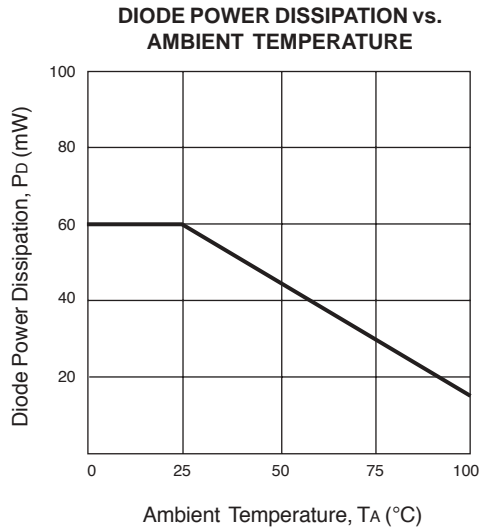

TYPICAL PERFORMANCE CURVES ($T_A = 25^\circ\text{C}$)

COLLECTOR TO EMITTER DARK CURRENT vs. AMBIENT TEMPERATURE

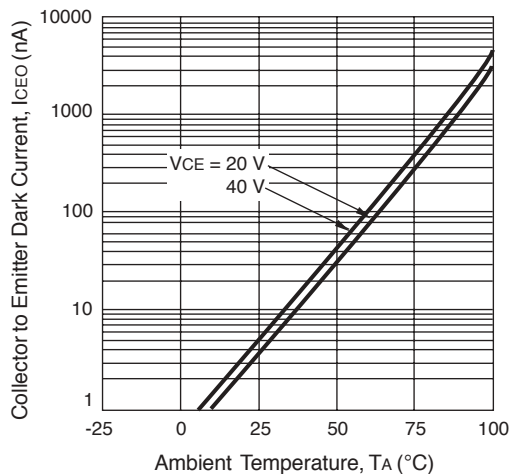

COLLECTOR CURRENT vs. COLLECTOR SATURATION VOLTAGE

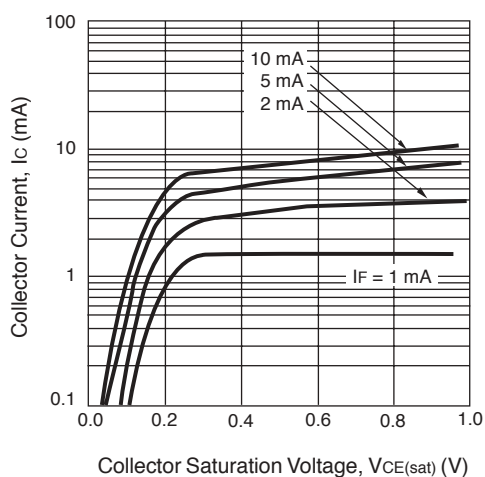

NORMALIZED CURRENT TRANSFER RATIO vs. AMBIENT TEMPERATURE

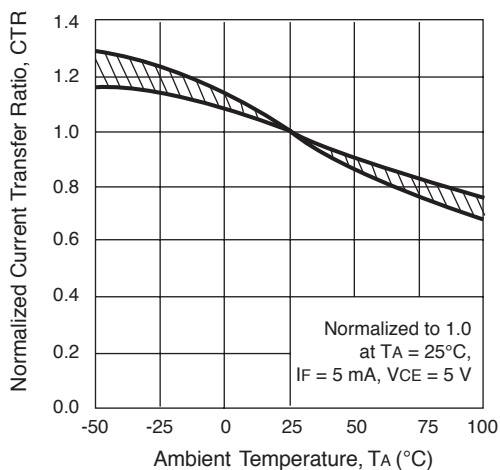

CURRENT TRANSFER RATIO vs. FORWARD CURRENT

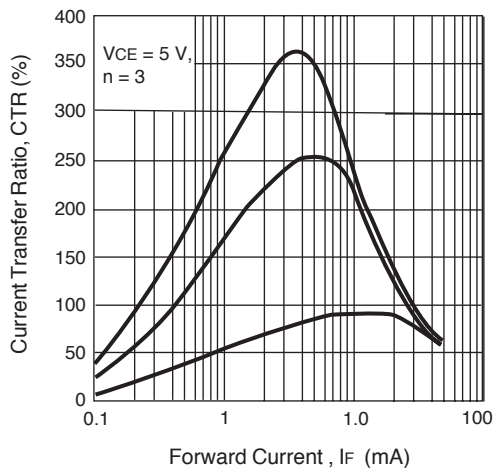

SWITCHING TIME vs. LOAD RESISTANCE

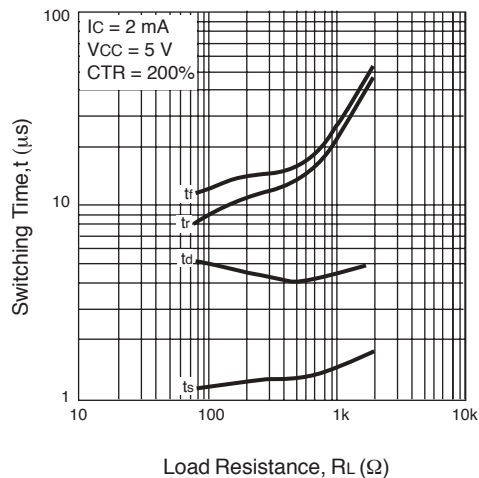

SWITCHING TIME vs. LOAD RESISTANCE

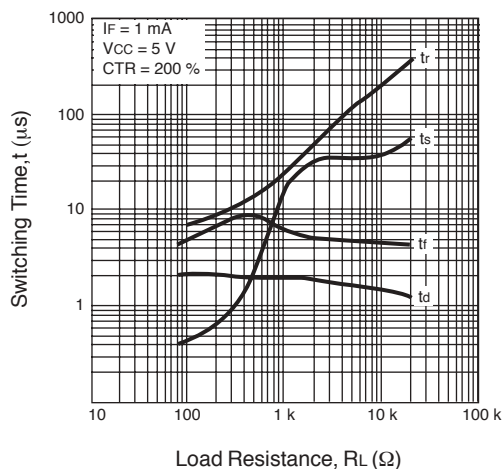

TYPICAL PERFORMANCE CURVES (TA = 25°C)

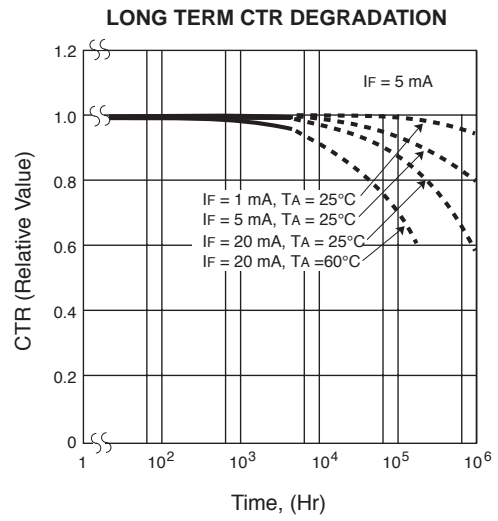
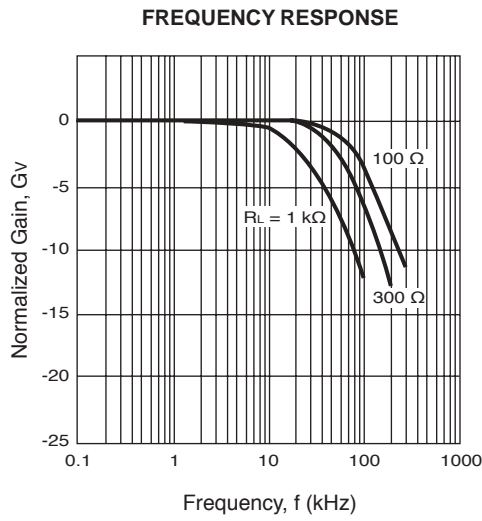

OUTLINE DIMENSIONS (Units in mm)

PHOTOCOUPLER CONSTRUCTION

PARAMETER	UNIT (MIN)
Air Distance	4.5 mm
Creepage Distance	4.5 mm
Isolation Distance	0.4 mm

PS2861-1

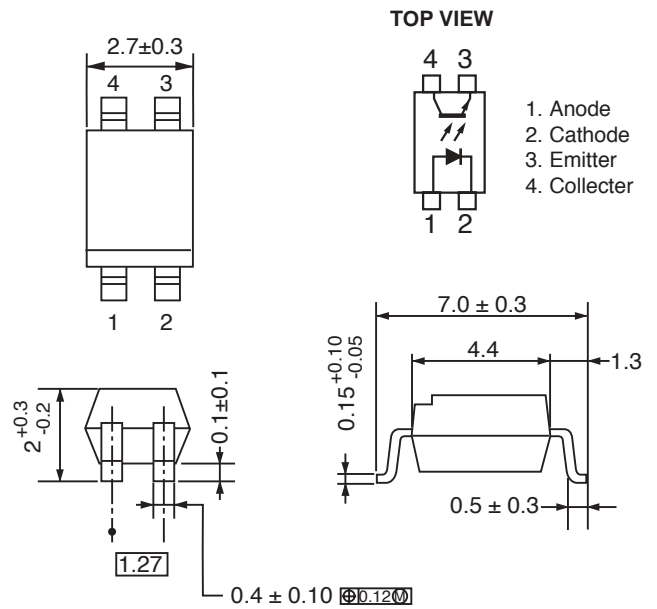

MARKING

Last number of type No.: 61

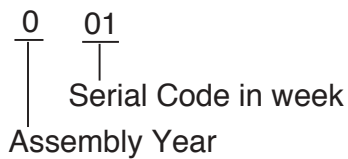

TAPING SPECIFICATIONS (Units in mm)

OUTLINE AND DIMENSIONS (TAPE)

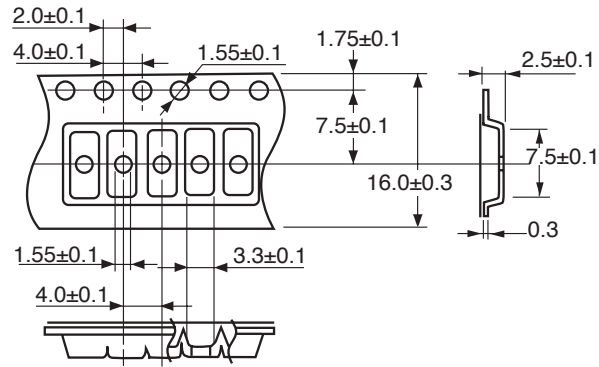

TAPING DIRECTION

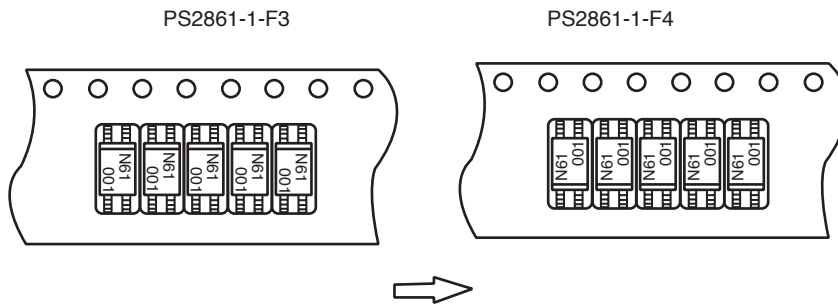

OUTLINE AND DIMENSIONS (REEL)

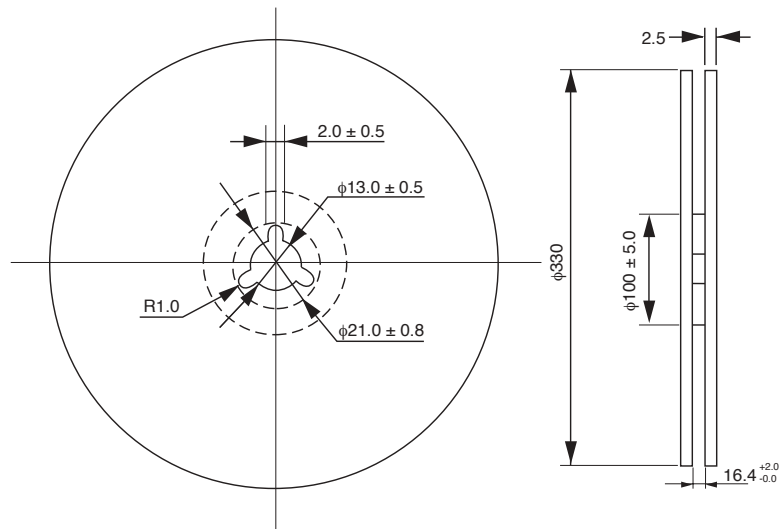

Packing: 3500 pcs/reel

1. Recommended Soldering Conditions

(1) Infrared reflow soldering

- Peak reflow temperature 235 °C (package surface temperature)
- Time of temperature higher than 210 °C 30 seconds or less
- Number of reflows Three
- Flux Rosin flux containing small amount of chlorine (The flux with a maximum chlorine content of 0.2 Wt % is recommended).

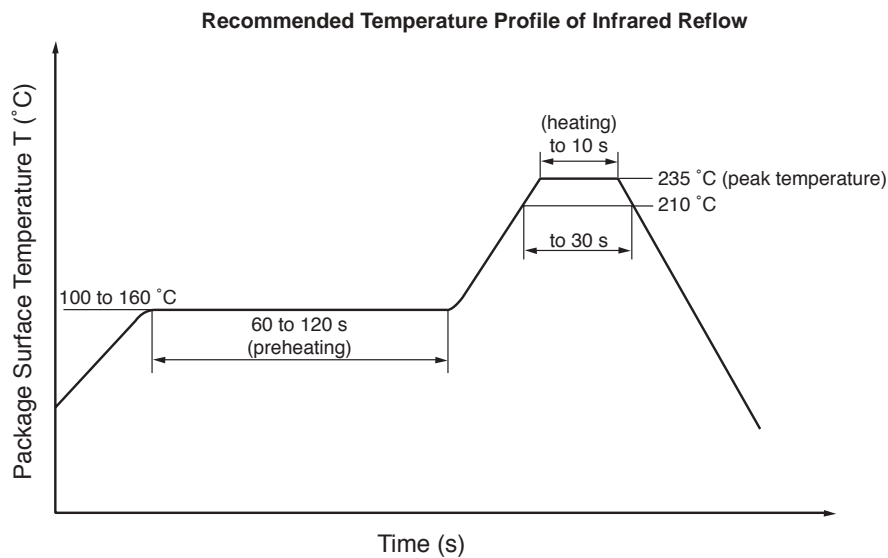

(2) Dip soldering

- Temperature 260 °C or below (molten solder temperature)
- Time 10 seconds or less
- Number of times One (allowed to be dipped in solder including plastic mold portion)
- Flux Rosin flux containing small amount of chlorine (The flux with a maximum chlorine content of 0.2 Wt % is recommended).

(3) Cautions

- Fluxes Avoid removing the residual flux with freon-based and chlorine-based cleaning solvent.

2. Cautions regarding noise

Be aware that when voltage is applied suddenly between the photocoupler's input and output or between collector -emitters at startup, the output side may enter the on state, even if the voltage is within the absolute maximum ratings.

Life Support Applications

These NEC products are not intended for use in life support devices, appliances, or systems where the malfunction of these products can reasonably be expected to result in personal injury. The customers of CEL using or selling these products for use in such applications do so at their own risk and agree to fully indemnify CEL for all damages resulting from such improper use or sale.

CEL California Eastern Laboratories, Your source for NEC RF, Microwave, Optoelectronic, and Fiber Optic Semiconductor Devices.

4590 Patrick Henry Drive • Santa Clara, CA 95054-1817 • (408) 988-3500 • FAX (408) 988-0279 • www.cel.com

DATA SUBJECT TO CHANGE WITHOUT NOTICE

10/14/2003