

T-37-21

INTERNATIONAL RECTIFIER

INTERNATIONAL RECTIFIER 

HEXFET® TRANSISTORS IRF9630

**P-CHANNEL
200 VOLT
POWER MOSFETs**

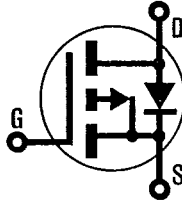

**IRF9631
IRF9632
IRF9633**

-200 Volt, 0.8 Ohm HEXFET TO-220AB Plastic Package

The HEXFET technology is the key to International Rectifier's advanced line of power MOSFET transistors. The efficient geometry and unique processing of the HEXFET design achieve very low on-state resistance combined with high transconductance and extreme device ruggedness.

The P-Channel HEXFETs are designed for applications which require the convenience of reverse polarity operation. They retain all of the features of the more common N-Channel HEXFETs such as voltage control, very fast switching, ease of paralleling, and excellent temperature stability. The P-Channel IRF9630 device is an approximate electrical complement to the N-Channel IRF620 HEXFET.

P-Channel HEXFETs are intended for use in power stages where complementary symmetry with N-Channel devices offers circuit simplification. They are also very useful in drive stages because of the circuit versatility offered by the reverse polarity connection. Applications include motor control, audio amplifiers, switched mode converters, control circuits and pulse amplifiers.

Product Summary

Part Number	V _{DS}	R _{DS(on)}	I _D
IRF9630	-200V	0.8Ω	-6.5A
IRF9631	-150V	0.8Ω	-6.5A
IRF9632	-200V	1.2Ω	-5.5A
IRF9633	-150V	1.2Ω	-5.5A

Features:

- P-Channel Versatility
- Compact Plastic Package
- Fast Switching
- Low Drive Current
- Ease of Paralleling
- Excellent Temperature Stability



CASE STYLE AND DIMENSIONS

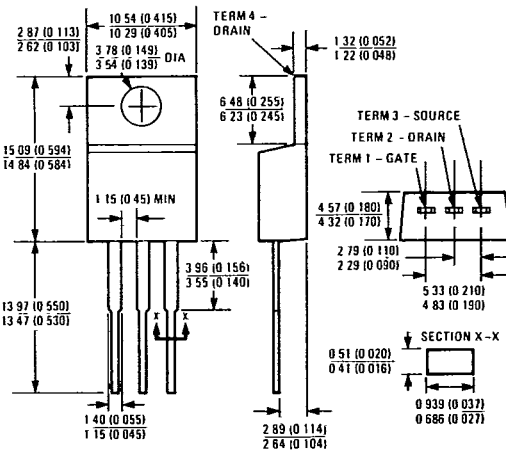
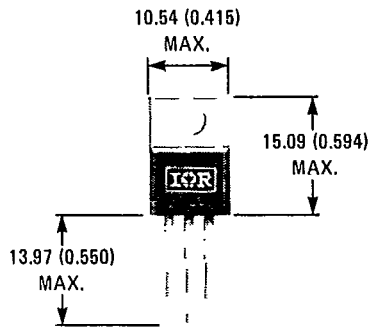

Case Style TO-220AB
All Dimensions in Millimeters and (Inches)

INTERNATIONAL RECTIFIER

Absolute Maximum Ratings

Parameter	IRF9630	IRF9631	IRF9632	IRF9633	Units
V _{DS} Drain - Source Voltage ①	-200	-150	-200	-150	V
V _{DGR} Drain - Gate Voltage (R _{GS} = 20 kΩ) ①	-200	-150	-200	-150	V
I _D @ T _C = 25°C Continuous Drain Current	-6.5	-6.5	-5.5	-5.5	A
I _D @ T _C = 100°C Continuous Drain Current	-4.0	-4.0	-3.5	-3.5	A
I _{DM} Pulsed Drain Current ③	-26	-26	-22	-22	A
V _{GS} Gate - Source Voltage	± 20				V
P _D @ T _C = 25°C Max. Power Dissipation	75 (See Fig. 14)				W
Linear Derating Factor	0.6 (See Fig. 14)				W/K ④
I _{LM} Inductive Current, Clamped	(See Fig. 15 and 16) L = 100 μH				A
	-26	-26	-22	-22	
T _J Operating Junction and Storage Temperature Range	-55 to 150				°C
T _{stg} Lead Temperature	300 (0.063 in. (1.6mm) from case for 10s)				°C

Electrical Characteristics @ T_C = 25°C (Unless Otherwise Specified)

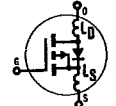
Parameter	Type	Min.	Typ.	Max.	Units	Test Conditions	
BV _{DSS} Drain - Source Breakdown Voltage	IRF9630 IRF9632	-200	—	—	V	V _{GS} = 0V	
	IRF9631 IRF9633	-150	—	—	V	I _D = -250 μA	
V _{GS(th)} Gate Threshold Voltage	ALL	-2.0	—	-4.0	V	V _{DS} = V _{GS} , I _D = -250 μA	
I _{GSS} Gate-Source Leakage Forward	ALL	—	—	-500	nA	V _{GS} = -20V	
I _{GSS} Gate-Source Leakage Reverse	ALL	—	—	500	nA	V _{GS} = 20V	
I _{DSS} Zero Gate Voltage Drain Current	ALL	—	—	-250	μA	V _{DS} = Max. Rating, V _{GS} = 0V	
		—	—	-1000	μA	V _{DS} = Max. Rating x 0.8, V _{GS} = 0V, T _C = 125°C	
I _{D(on)} On-State Drain Current ②	IRF9630 IRF9631	-6.5	—	—	A	V _{DS} > I _{D(on)} x R _{DS(on)} max.; V _{GS} = -10V	
	IRF9632 IRF9633	-5.5	—	—	A		
R _{DS(on)} Static Drain-Source On-State Resistance ②	IRF9630 IRF9631	—	0.5	0.8	Ω	V _{GS} = -10V, I _D = -3.5A	
	IRF9632 IRF9633	—	0.8	1.2	Ω		
g _{fs} Forward Transconductance ②	ALL	2.2	3.5	—	S (ft)	V _{DS} > I _{D(on)} x R _{DS(on)} max.; I _D = -3.5A	
C _{iss} Input Capacitance	ALL	—	550	650	pF	V _{GS} = 0V, V _{DS} = -25V, f = 1.0 MHz See Fig. 10	
C _{oss} Output Capacitance	ALL	—	170	300	pF		
C _{rss} Reverse Transfer Capacitance	ALL	—	50	90	pF	V _{DD} = 0.5 BV _{DSS} , I _D = -3.5A, Z _o = 50Ω See Fig. 17 (MOSFET switching times are essentially independent of operating temperature.)	
t _{d(on)} Turn-On Delay Time	ALL	—	30	50	ns		
t _r Rise Time	ALL	—	50	100	ns		
t _{d(off)} Turn-Off Delay Time	ALL	—	50	100	ns		
t _f Fall Time	ALL	—	40	80	ns		
Q _g Total Gate Charge (Gate-Source Plus Gate-Drain)	ALL	—	31	45	nC	V _{GS} = -15V, I _D = -8.0A, V _{DS} = 0.8 Max. Rating. See Fig. 18 for test circuit. (Gate charge is essentially independent of operating temperature.)	
Q _{gs} Gate-Source Charge	ALL	—	18	—	nC		
Q _{gd} Gate-Drain ("Miller") Charge	ALL	—	13	—	nC		
L _D Internal Drain Inductance	ALL	—	3.5	—	nH	Measured from the contact screw on tab to center of die.	Modified MOSFET symbol showing the internal device inductances. 
		—	4.5	—	nH	Measured from the drain lead, 6mm (0.25 in.) from package to center of die.	
L _S Internal Source Inductance	ALL	—	7.5	—	nH	Measured from the source lead, 6mm (0.25 in.) from package to source bonding pad.	

Thermal Resistance

R _{thJC} Junction-to-Case	ALL	—	—	1.67	K/W ④	
R _{thCS} Case-to-Sink	ALL	—	1.0	—	K/W ④	Mounting surface flat, smooth, and greased.
R _{thJA} Junction-to-Ambient	ALL	—	—	80	K/W ④	Typical socket mount

IRF9630, IRF9631, IRF9632, IRF9633 Devices

INTERNATIONAL RECTIFIER

Source-Drain Diode Ratings and Characteristics

I_S	Continuous Source Current (Body Diode)	IRF9630	-	-	-6.5	A	Modified MOSFET symbol showing the integral reverse P-N junction rectifier.
		IRF9631	-	-	-6.5	A	
I_{SM}	Pulse Source Current (Body Diode) ③	IRF9630	-	-	-26	A	
		IRF9631	-	-	-26	A	
V_{SD}	Diode Forward Voltage ②	IRF9630	-	-	-6.5	V	$T_C = 25^\circ\text{C}, I_S = -6.5\text{A}, V_{GS} = 0\text{V}$
		IRF9631	-	-	-6.5	V	$T_C = 25^\circ\text{C}, I_S = -6.5\text{A}, V_{GS} = 0\text{V}$
t_{rr}	Reverse Recovery Time	IRF9632	-	-	-	ns	$T_J = 150^\circ\text{C}, I_F = -6.5\text{A}, di_F/dt = 100\text{A}/\mu\text{s}$
		IRF9633	-	-	-	ns	$T_J = 150^\circ\text{C}, I_F = -6.5\text{A}, di_F/dt = 100\text{A}/\mu\text{s}$
Q_{RR}	Reverse Recovered Charge	ALL	-	2.6	-	μC	$T_J = 150^\circ\text{C}, I_F = -6.5\text{A}, di_F/dt = 100\text{A}/\mu\text{s}$
t_{on}	Forward Turn-on Time	ALL	Intrinsic turn-on time is negligible. Turn-on speed is substantially controlled by $L_S + L_D$.				

T-39-21



- ① $T_J = 25^\circ\text{C}$ to 150°C .
- ② Pulse Test: Pulse width $\leq 300\mu\text{s}$, Duty Cycle $\leq 2\%$.
- ③ Repetitive Rating: Pulse width limited by max. junction temperature. See Transient Thermal Impedance Curve (Fig. 5).
- ④ $K/W = ^\circ\text{C}/\text{W}$
 $W/K = \text{W}/^\circ\text{C}$

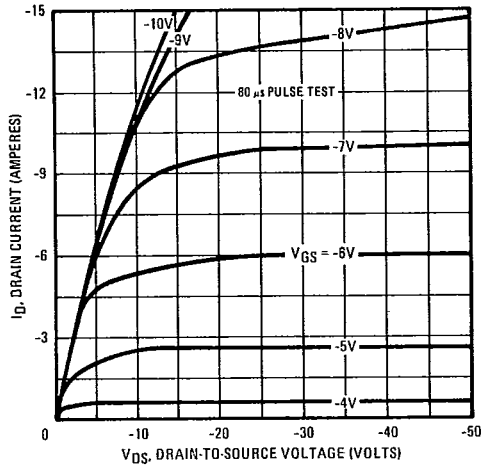

Fig. 1 - Typical Output Characteristics

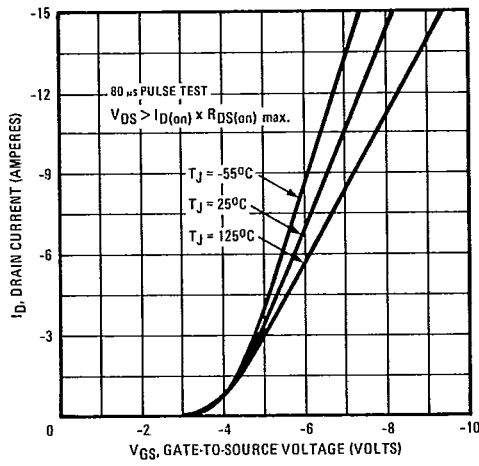

Fig. 2 - Typical Transfer Characteristics

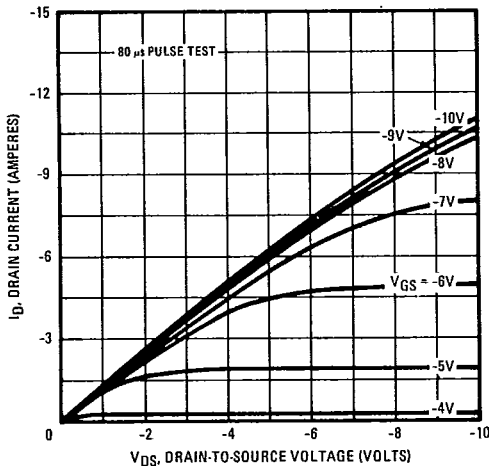

Fig. 3 - Typical Saturation Characteristics

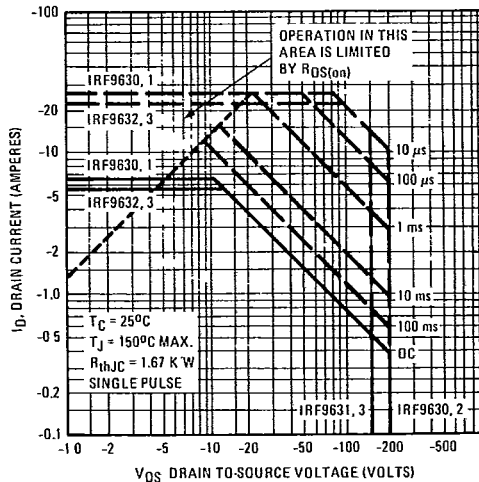

Fig. 4 - Maximum Safe Operating Area

INTERNATIONAL RECTIFIER T-39-21

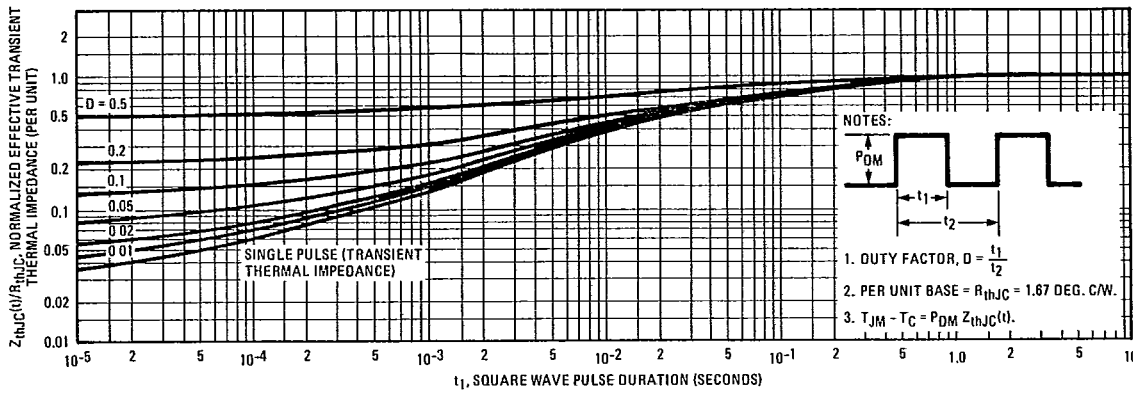

Fig. 5 – Maximum Effective Transient Thermal Impedance, Junction-to-Case Vs. Pulse Duration

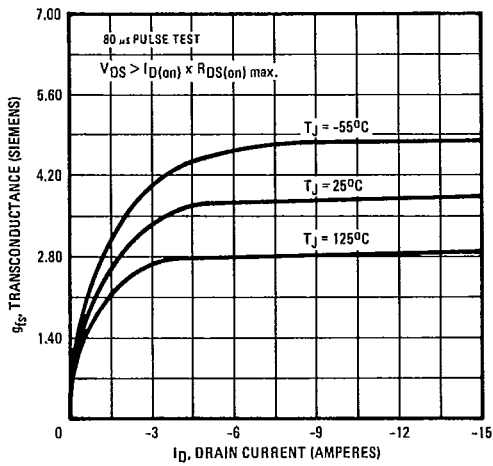

Fig. 6 – Typical Transconductance Vs. Drain Current

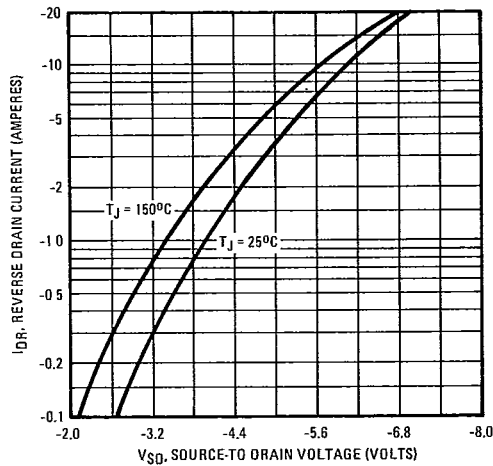

Fig. 7 – Typical Source-Drain Diode Forward Voltage

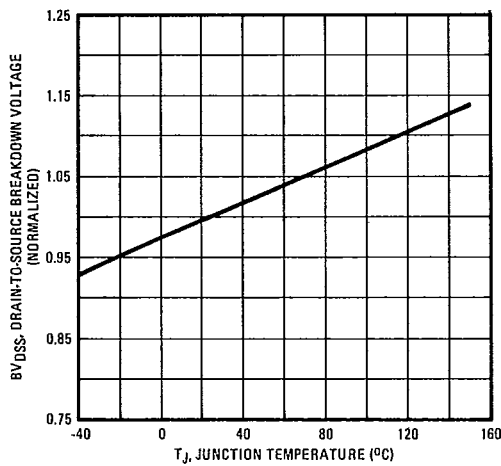

Fig. 8 – Breakdown Voltage Vs. Temperature

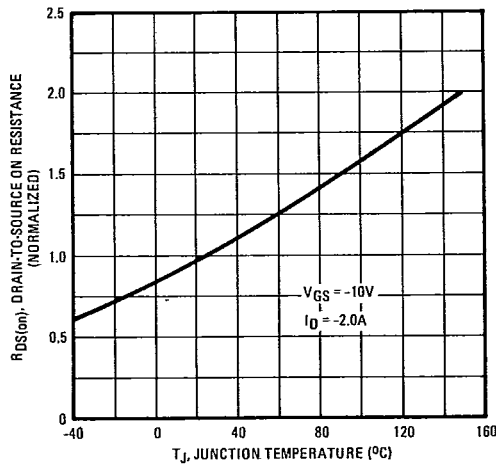

Fig. 9 – Normalized On-Resistance Vs. Temperature

INTERNATIONAL RECTIFIER T-39-21

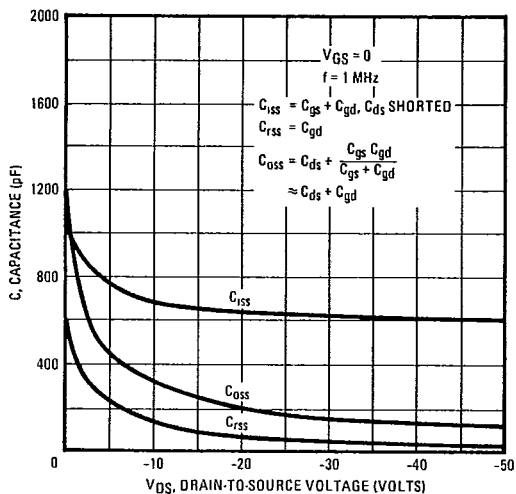

Fig. 10 - Typical Capacitance Vs. Drain-to-Source Voltage

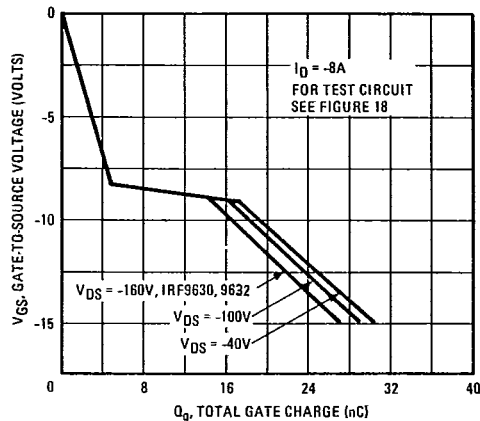

Fig. 11 - Typical Gate Charge Vs. Gate-to-Source Voltage

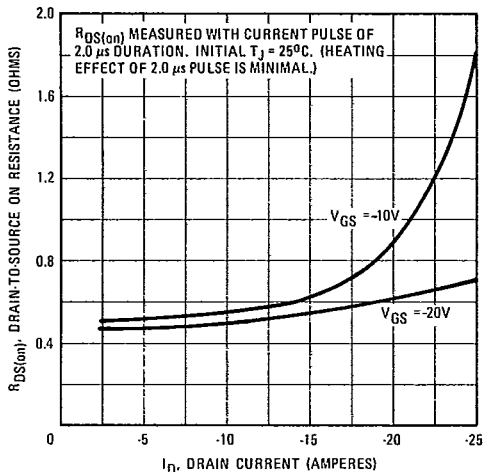

Fig. 12 - Typical On-Resistance Vs. Drain Current

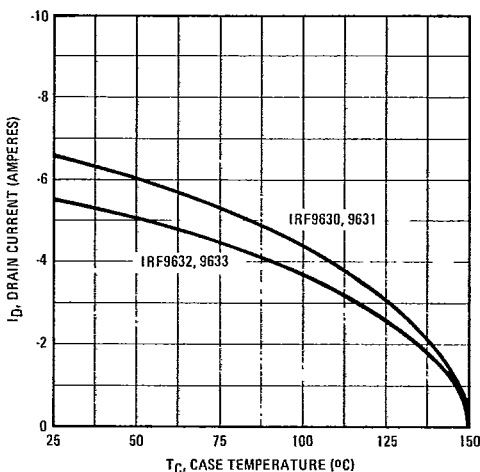

Fig. 13 - Maximum Drain Current Vs. Case Temperature

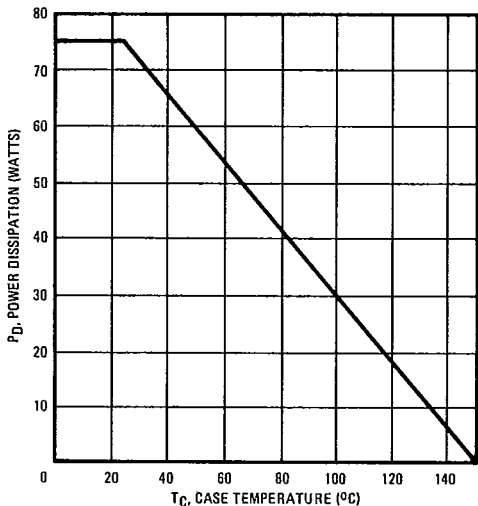

Fig. 14 - Power Vs. Temperature Derating Curve

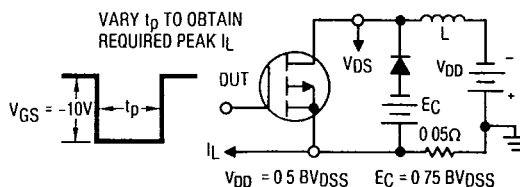

Fig. 15 - Clamped Inductive Test Circuit

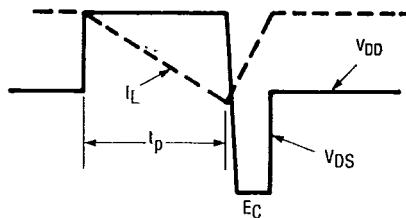

Fig. 16 - Clamped Inductive Waveforms



INTERNATIONAL RECTIFIER

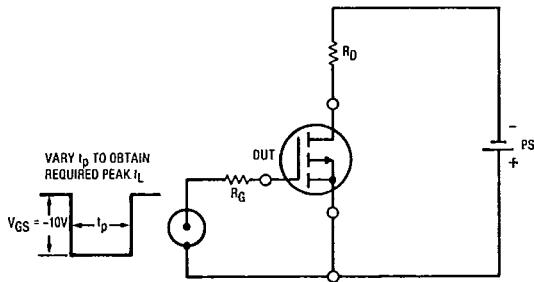

Fig. 17 — Switching Time Test Circuit

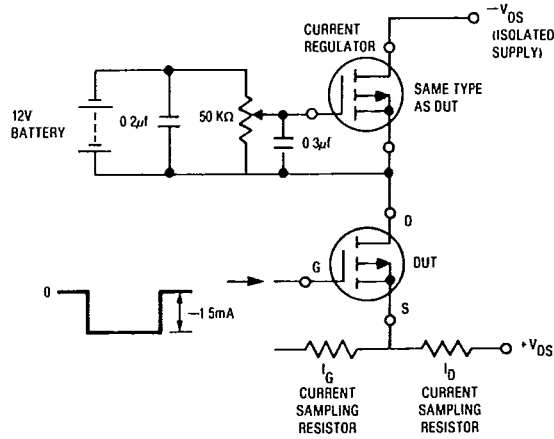
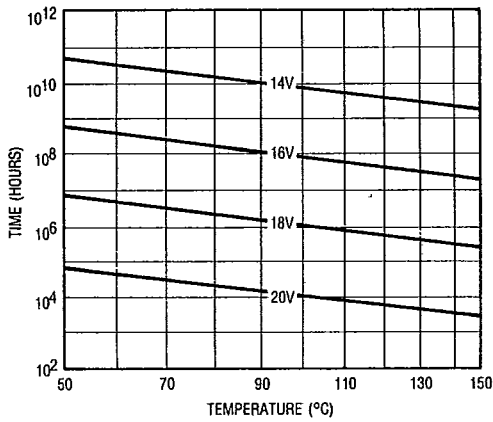
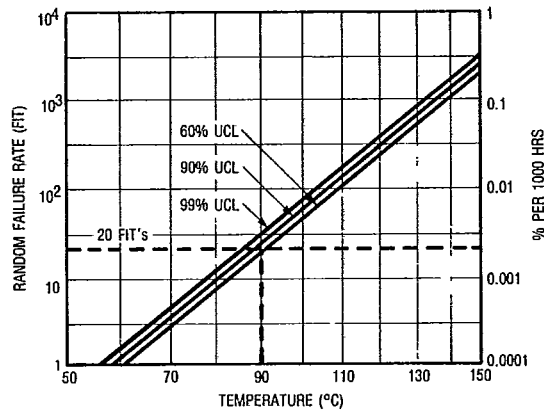

Fig. 18 — Gate Charge Test Circuit



*Fig. 19 — Typical Time to Accumulated 1% Failure



*Fig. 20 — Typical High Temperature Reverse Bias (HTRB) Failure Rate

*The data shown in correct as of April 15, 1987. This information is updated on a quarterly basis; for the latest reliability data, please contact your local IR field office.