

## 0.5 dB LSB GaAs MMIC 6-BIT DIGITAL POSITIVE CONTROL ATTENUATOR, DC - 3.0 GHz

### Typical Applications

The HMC472LP4 is ideal for both RF and IF applications:

- Cellular; UMTS/3G Infrastructure
- ISM, MMDS, WLAN, WiMAX
- Microwave Radio & VSAT
- Test Equipment & Sensors

### Functional Diagram

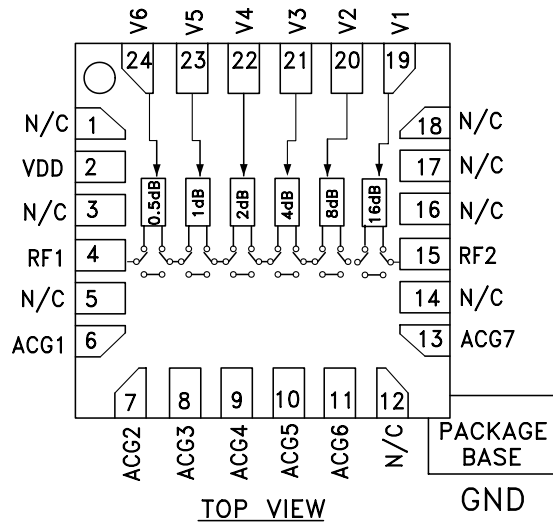

### Features

- 0.5 dB LSB Steps to 31.5 dB
- Single Control Line Per Bit
- TTL/CMOS Compatible Control
- +/- 0.5 dB Typical Step Error
- Single +5V Supply
- 4 mm x 4 mm x 1 mm SMT Package

### General Description

The HMC472LP4 is a broadband 6-bit GaAs IC digital attenuator in a low cost leadless surface mount package. This single positive control line per bit digital attenuator incorporates off chip AC ground capacitors for near DC operation, making it suitable for a wide variety of RF and IF applications. Covering DC to 3.0 GHz, the insertion loss is less than 2.0 dB typical. The attenuator bit values are 0.5 (LSB), 1, 2, 4, 8, and 16 dB for a total attenuation of 31.5 dB. Attenuation accuracy is excellent at  $\pm 0.5$  dB typical step error with an IIP3 of +45 dBm. Six TTL/CMOS control inputs are used to select each attenuation state. A single Vdd bias of +5V is required.

### Electrical Specifications,

$T_a = +25^\circ \text{C}$ , With  $V_{dd} = +5\text{V}$  &  $V_{ctl} = 0/+5\text{V}$  (Unless Otherwise Noted)

Parameter	Frequency (GHz)	Min.	Typ.	Max.	Units
Insertion Loss	DC - 1.5 GHz		1.5	1.8	dB
	1.5 - 3.0 GHz		2.0	2.3	dB
Attenuation Range	DC - 3.0 GHz		31.5		dB
Return Loss (RF1 & RF2, All Atten. States)	DC - 3.0 GHz		15		dB
Attenuation Accuracy: (Referenced to Insertion Loss)	DC - 3.0 GHz	REF - 15.5 dB	$\pm (0.4 + 4\% \text{ of Atten. Setting}) \text{ Max.}$		dB
		16.0 - 31.5 dB	$\pm (0.5 + 4\% \text{ of Atten. Setting}) \text{ Max.}$		dB
Input Power for 0.1 dB Compression	0.1 - 3.0 GHz		20		dBm
Input Third Order Intercept Point (Two-Tone Input Power= 0 dBm Each Tone)	0.1 - 3.0 GHz	REF - 15.5 dB States	45		dBm
		16.0 - 31.5 dB States	35		dBm
Switching Characteristics	DC - 3.0 GHz	tRISE, tFALL (10/90% RF)	130		ns
		tON, tOFF (50% CTL to 10/90% RF)	140		ns

**0.5 dB LSB GaAs MMIC 6-BIT DIGITAL POSITIVE CONTROL ATTENUATOR, DC - 3.0 GHz**

**Insertion Loss**

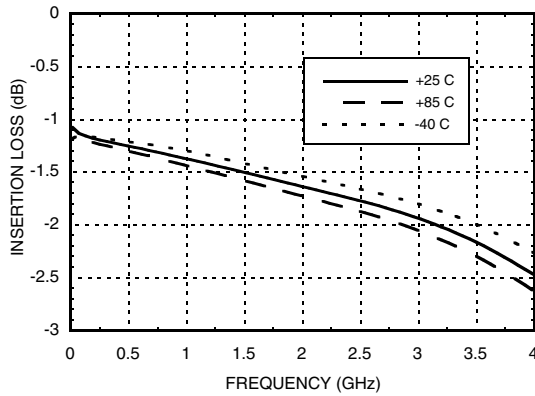

**Return Loss RF1, RF2**  
(Only Major States are Shown)

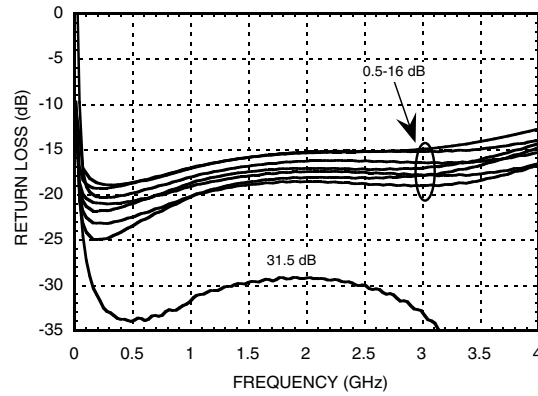

**Normalized Attenuation**  
(Only Major States are Shown)

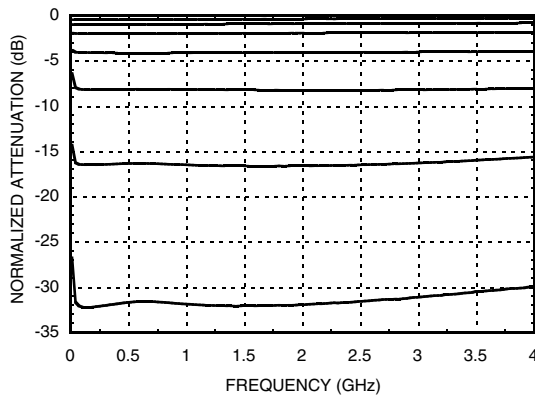

**Bit Error vs. Attenuation State**

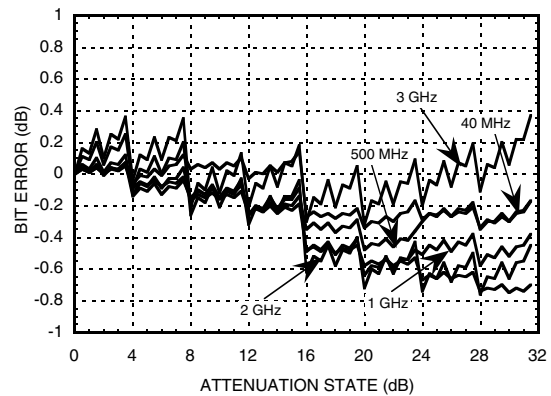

**Bit Error vs. Frequency**  
(Only Major States are Shown)

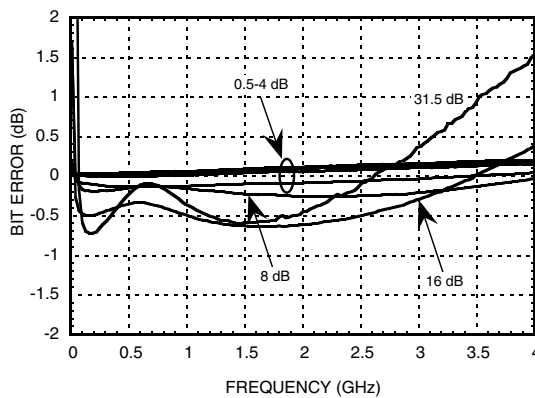

**Relative Phase vs. Frequency**  
(Only Major States are Shown)

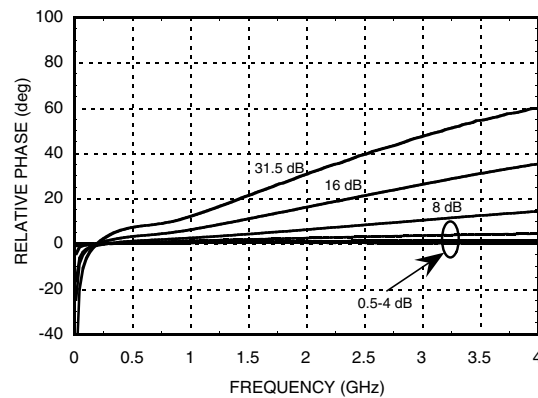

## 0.5 dB LSB GaAs MMIC 6-BIT DIGITAL POSITIVE CONTROL ATTENUATOR, DC - 3.0 GHz

### Worst Case Step Error Between Successive Attenuation States

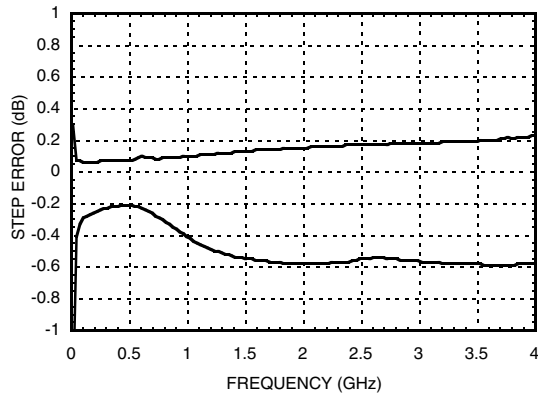

### Bias Voltage & Current

Vdd = +5.0 Vdc ± 10%	
Vdd (VDC)	Idd (Typ.) (mA)
+4.5	4.7
+5.0	5.0
+5.5	5.3

### Control Voltage

State	Bias Condition
Low	0 to +0.8 Vdc @ -5 uA Typ.
High	+ 2.0 to + 5.0 Vdc @ 40 uA Typ.

Note: Vdd = +5V

### Truth Table

Control Voltage Input						Attenuation State RF1 - RF2
V1 16 dB	V2 8 dB	V3 4 dB	V4 2 dB	V5 1 dB	V6 0.5 dB	
High	High	High	High	High	High	Reference I.L.
High	High	High	High	High	Low	0.5 dB
High	High	High	High	Low	High	1 dB
High	High	High	Low	High	High	2 dB
High	High	Low	High	High	High	4 dB
High	Low	High	High	High	High	8 dB
Low	High	High	High	High	High	16 dB
Low	Low	Low	Low	Low	Low	31.5 dB

Any combination of the above states will provide an attenuation approximately equal to the sum of the bits selected.

## 0.5 dB LSB GaAs MMIC 6-BIT DIGITAL POSITIVE CONTROL ATTENUATOR, DC - 3.0 GHz

### Absolute Maximum Ratings

RF Input Power (DC - 3.0 GHz)	+27 dBm (T = +85 °C)
Control Voltage Range (V1 to V6)	-1V to Vdd +1V
Bias Voltage (Vdd)	+7.0 Vdc
Channel Temperature	150 °C
Continuous Pdiss (T = 85 °C) (derate 7.7 mW/°C above 85 °C)	0.5 W
Thermal Resistance	130 °C/W
Storage Temperature	-65 to +150 °C
Operating Temperature	-40 to +85 °C



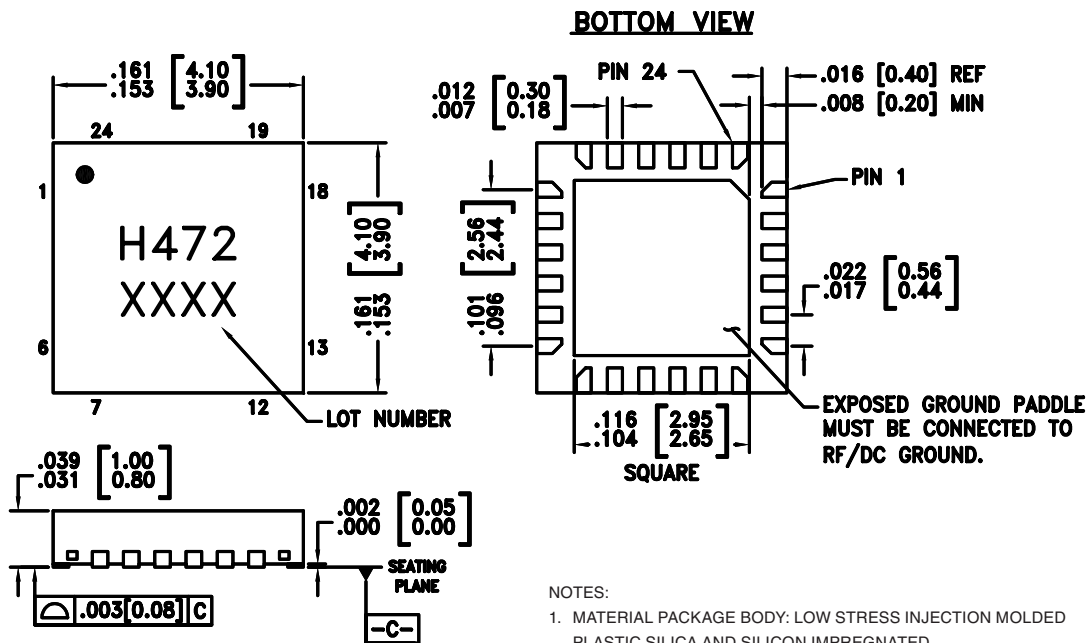

ELECTROSTATIC SENSITIVE DEVICE  
OBSERVE HANDLING PRECAUTIONS

### Outline Drawing

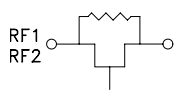
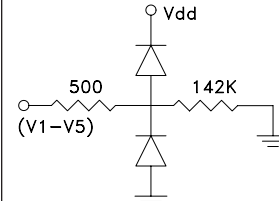

## 0.5 dB LSB GaAs MMIC 6-BIT DIGITAL POSITIVE CONTROL ATTENUATOR, DC - 3.0 GHz

### Pin Descriptions

Pin Number	Function	Description	Interface Schematic
1, 3, 5, 12, 14, 16, 17, 18	N/C	These pins should be connected to PCB RF ground to maximize performance.	
2	Vdd	Supply Voltage.	
4, 15	RF1, RF2	This pin is DC coupled and matched to 50 Ohm. Blocking capacitors are required. Select value based on lowest frequency of operation.	
6 - 11, 13	ACG1 - ACG7	External capacitor to ground is required. Select value for lowest frequency of operation. Place capacitor as close to pins as possible.	
19 - 24	V1 - V6	See truth table and control voltage table.	
	GND	Package bottom has an exposed metal paddle that must also be connected to RF/DC Ground.	

### Application Circuit

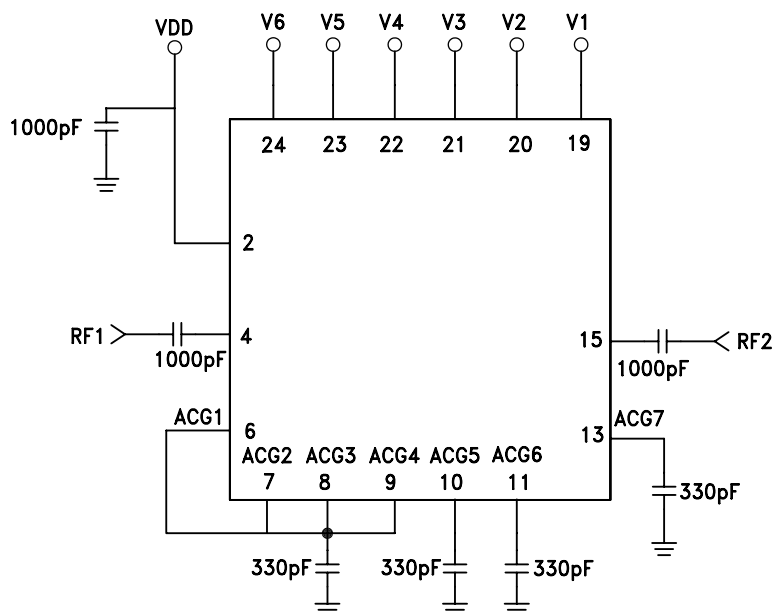

**0.5 dB LSB GaAs MMIC 6-BIT DIGITAL  
POSITIVE CONTROL ATTENUATOR, DC - 3.0 GHz**

**Evaluation PCB**

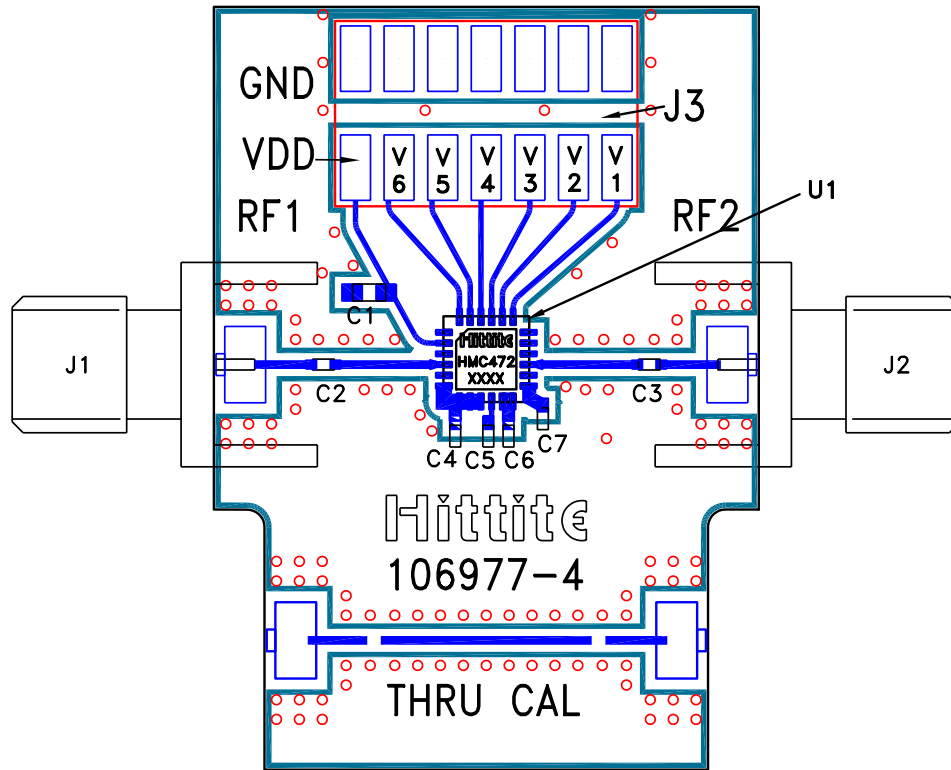

**List of Material for Evaluation PCB 107010 [1]**

Item	Description
J1 - J2	PC Mount SMA Connector
J3	14 Pin DC Connector
C1	1000 pF Capacitor, 0603 Pkg.
C2, C3	1000 pF Capacitor, 0402 Pkg.
C4 - C7	330 pF Capacitor, 0402 Pkg.
U1	HMC472LP4 Digital Attenuator
PCB [2]	106977 Evaluation PCB

[1] Reference this number when ordering complete evaluation PCB

[2] Circuit Board Material: Rogers 4350

The circuit board used in the final application should use RF circuit design techniques. Signal lines should have 50 ohm impedance while the package ground leads and exposed paddle should be connected directly to the ground plane similar to that shown. A sufficient number of via holes should be used to connect the top and bottom ground planes. The evaluation circuit board shown is available from Hittite upon request.