



## SINGLE COMPARATOR

### ■ GENERAL DESCRIPTION

The NJM2406F is a single comparator of ultra miniature surface mount package.

The NJM2406F is suitable for small electronic equipments and hybrid circuits.

### ■ PACKAGE OUTLINE

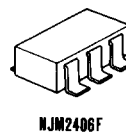

### ■ FEATURES

- Operating Voltage (±2.5V ~ ±7V)
- Single Supply Operation
- Mounted in Ultra Miniature Package 2.9×1.5mm (1/5 of DMP-8 package)
- Ground Shield Plate between + Input and Output
- Ground Shield Plate between + Input and - Input
- Suitable Pin Arrangement for Application
- Package Outline MTP5
- Bipolar Technology

### ■ PIN CONFIGURATION

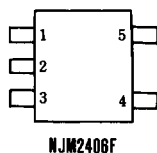

#### PIN FUNCTION

1. -INPUT
2. GND
3. +INPUT
4. OUTPUT
5. V<sup>+</sup>

### ■ EQUIVALENT CIRCUIT

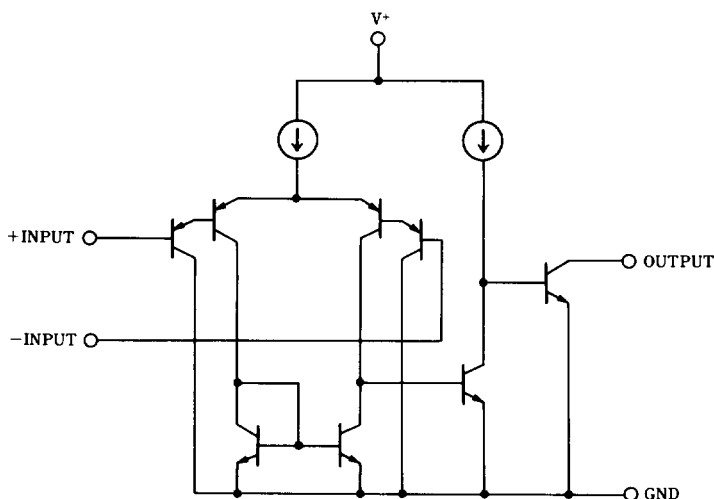



■ ABSOLUTE MAXIMUM RATINGS

(Ta=25°C)

PARAMETER	SYMBOL	RATINGS	UNIT
Supply Voltage	V*	7	V
Differential Input Voltage	V <sub>ID</sub>	7	V
Input Voltage	V <sub>IN</sub>	-0.3 to 7	V
Power Dissipation	P <sub>D</sub>	200	mW
Output to Negative Supply Voltage	V <sub>SUS</sub>	20	V
Operating Temperature Range	T <sub>OPR</sub>	-20 to +75	°C
Storage Temperature Range	T <sub>STG</sub>	-40 to +125	°C

■ ELECTRICAL CHARACTERISTICS

(V\*=5V, Ta=25°C)

PARAMETER	SYMBOL	TEST CONDITION	MIN.	TYP.	MAX.	UNIT
Input Offset Voltage	V <sub>IO</sub>	R <sub>S</sub> = 0Ω, V <sub>O</sub> = 1.4V	—	1	7	mV
Input Offset Current	I <sub>IO</sub>		—	1	50	nA
Input Bias Current	I <sub>B</sub>		—	20	250	nA
Input Common Mode Voltage Range	V <sub>ICM</sub>		0~3.5	—	—	V
Large Signal Voltage Gain	A <sub>V</sub>	R <sub>L</sub> = 15kΩ	—	106	—	dB
Response Time	t <sub>R</sub>	R <sub>L</sub> = 5.1kΩ	—	1.5	—	μs
Output Sink Current	I <sub>SINK</sub>	V <sub>IN</sub> <sup>-</sup> = 1V, V <sub>IN</sub> <sup>+</sup> = 0V, V <sub>O</sub> = 1.5V	6	—	—	mA
Output Saturation Voltage	V <sub>SAT</sub>	V <sub>IN</sub> <sup>-</sup> = 1V, V <sub>IN</sub> <sup>+</sup> = 0V, I <sub>SINK</sub> = 5mA	—	300	500	mV
Output Leakage Current	I <sub>LEAK</sub>	V <sub>IN</sub> <sup>-</sup> = 0V, V <sub>IN</sub> <sup>+</sup> = 1V, V <sub>O</sub> = 20V	—	—	1	μA
Operating Current	I <sub>CC</sub>		200	400	800	μA





## ■ TYPICAL CHARACTERISTICS

**Input Bias Current vs. Temperature**  
( $V^+ = 5\text{ V}$ )

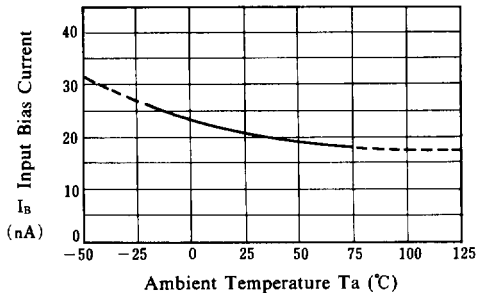

**Input Offset Voltage vs. Temperature**  
( $V^+ = 5\text{ V}$ )

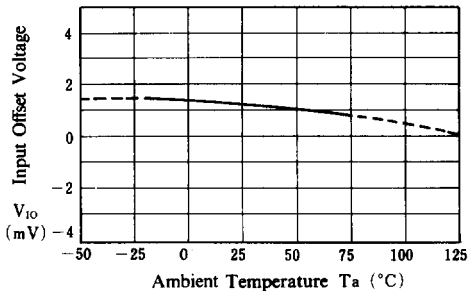

**Operating Current vs. Operating Voltage**  
( $T_a = 25^\circ\text{C}$ )

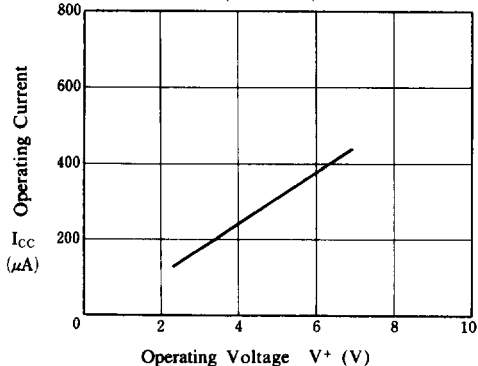

**Input Bias Current vs. Operating Voltage**  
( $T_a = 25^\circ\text{C}$ )

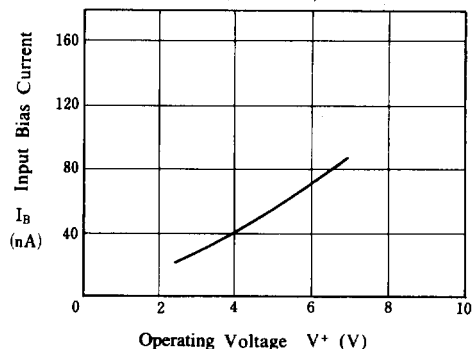

**Output Saturation Voltage vs. Output Sink Current**  
( $V^+ = 5\text{ V}$ )

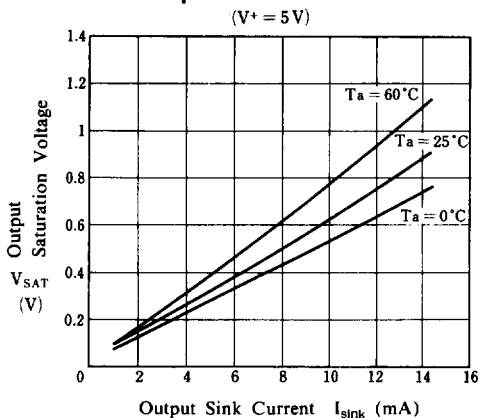

**Output Saturation Voltage vs. Operating Voltage**  
( $T_a = 25^\circ\text{C}$ )

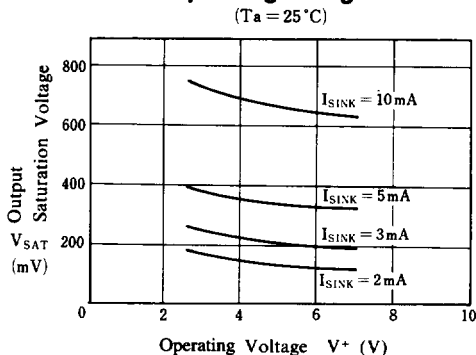



■ TYPICAL CHARACTERISTICS

Response Time for Various Input Over Drives  
( $T_a = 25^\circ\text{C}$ )

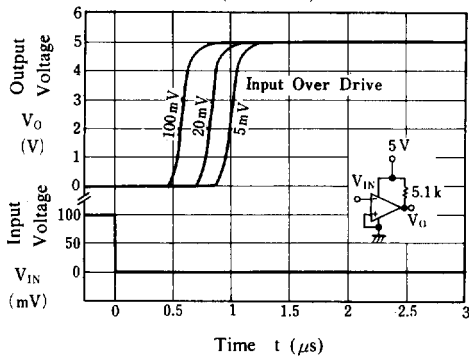

Response Time for Various Input Over Drives  
( $T_a = 25^\circ\text{C}$ )

