



Product Preview

9-Bit Register With 3-State Outputs (Non-Inverting)

The MC74AC/ACT823 consists of nine D-type edge-triggered flip-flops. This device has 3-state outputs for bus systems, organized in a broadside pinning. In addition to the clock and output enabled pins, the buffered clock (CP) and buffered Output Enable (OE) are common to all flip-flops. The flip-flops will store the state of their individual D inputs that meet the setup and hold time requirements on the LOW-to-HIGH CP transition. With OE LOW, the contents of the flip-flops are available at the outputs. When OE is HIGH, the outputs go to the high impedance state.

Operation of the OE input does not affect the state of the flip-flops. The MC74AC/ACT823 has Clear (CLR) and Clock Enable (EN) pins. These devices are ideal for parity bus interfacing in high performance systems.

When CLR is LOW, and OE is LOW, the outputs are LOW. When CLR is HIGH, data can be entered into the flip-flops. When EN is LOW, data on the inputs is transferred to the outputs on the LOW-to-HIGH clock transition. When EN is HIGH, the outputs do not change state, regardless of the data or clock input transitions.

- 3-State Outputs for Bus Interfacing
- Broad Side Pin Configuration
- ACT has TTL – Compatible Inputs
- High Speed Parallel Positive Edge-Triggered D-Type Flip-Flops
- High Performance Bus Interface Buffering for Busses Carrying Parity
- Outputs Source/Sink 24 mA

Pinout: 24-Lead Packages (Top View)

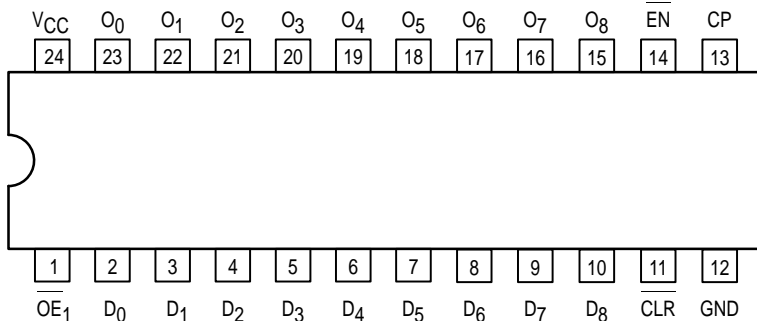

FUNCTION TABLE

Inputs					Internal	Outputs	Operating Mode
OE	CLR	EN	CP	D _n	Q	O	
H	X	L	↑	L	L	Z	High Z
H	X	L	↑	H	H	Z	High Z
H	L	X	X	X	L	Z	Clear
L	L	X	X	X	L	L	Clear
H	H	H	X	X	NC	Z	Hold
L	H	H	X	X	NC	NC	Hold
H	H	L	↑	L	L	Z	Load
H	H	L	↑	H	H	Z	Load
L	H	L	↑	L	L	L	Load
L	H	L	↑	H	H	H	Load

H = HIGH Voltage Level; L = LOW Voltage Level; X = Immaterial; Z = High Impedance State; ↑ = LOW-to-High Transition; NC = No Change

This document contains information on a product under development. Motorola reserves the right to change or discontinue this product without notice.

MC74AC823
MC74ACT823

9-BIT REGISTER WITH 3-STATE OUTPUTS

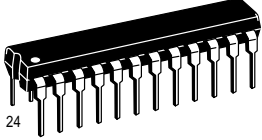

N SUFFIX
CASE 724-03
PLASTIC PACKAGE

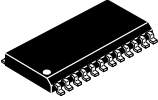

DW SUFFIX
CASE 751E-04
SOIC PACKAGE

PIN NAMES

- D₀ – D₈ Data Inputs
- O₀ – O₈ Data Outputs
- OE Output Enable
- EN Clock Enable
- CLR Clear
- CP Clock Input

MC74AC823 MC74ACT823

LOGIC SYMBOL

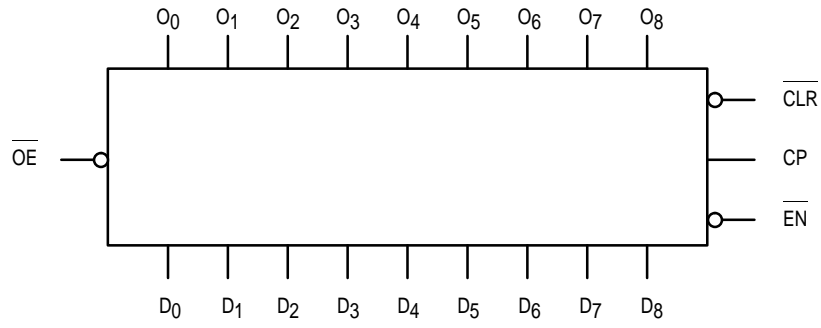

LOGIC DIAGRAM

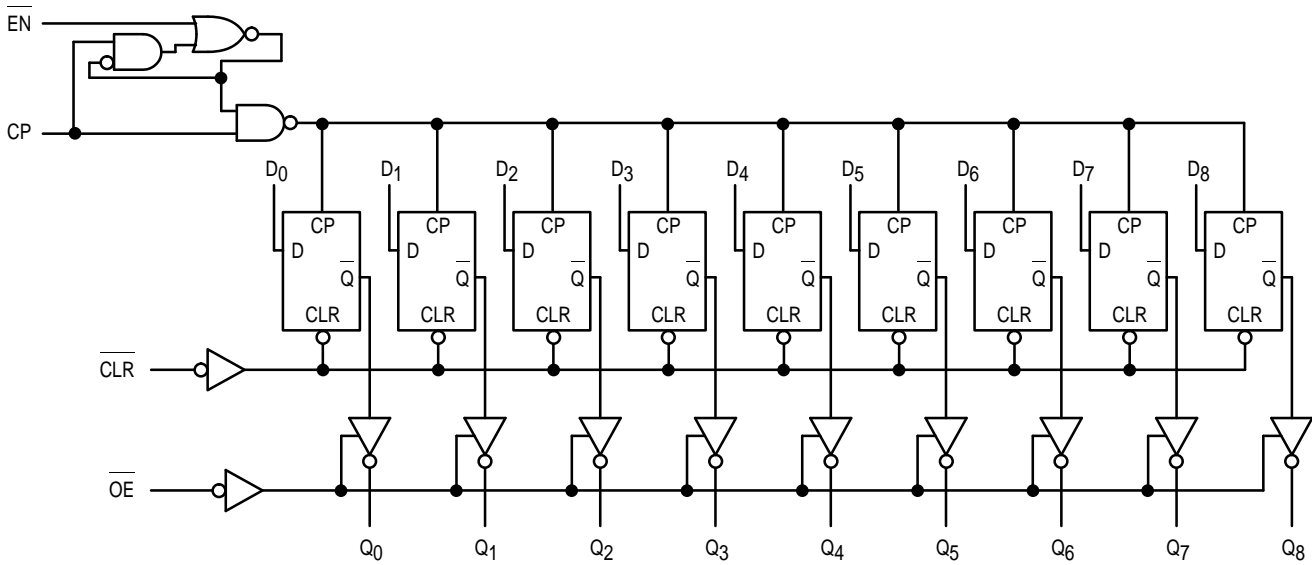

MC74AC823 MC74ACT823

MAXIMUM RATINGS*

Symbol	Parameter	Value	Units
V _{CC}	DC Supply Voltage (Referenced to GND)	-0.5 to +7.0	V
V _{in}	DC Input Voltage (Referenced to GND)	-0.5 to V _{CC} + 0.5	V
V _O	DC Output Voltage (Referenced to GND)	-0.5 to V _{CC} + 0.5	V
I _{in}	DC Input Current, per Pin	± 20	mA
I _{out}	DC Output Sink/Source Current, per Pin	± 50	mA
I _{CC}	DC V _{CC} or GND Current per Output Pin	± 50	mA
T _{stg}	Storage Temperature Range	-65 to +150	°C

* Maximum Ratings are those values beyond which damage to the device may occur. Functional operation should be restricted to the Recommended Operating Conditions.

RECOMMENDED OPERATING CONDITIONS

Symbol	Parameter	Min	Typ	Max	Unit	
V _{CC}	Supply Voltage	'AC	2.0	5.0	6.0	V
		'ACT	4.5	5.0	5.5	
V _{in}	DC Input Voltage, Output Voltage (Ref. to GND)	0		V _{CC}	V	
Δt/Δv	Input Rise and Fall Time (Note 1) 'AC Devices except Schmitt Inputs	V _{CC} @ 3.0 V		150		ns/V
		V _{CC} @ 4.5 V		40		
		V _{CC} @ 5.5 V		25		
t _r , t _f	Input Rise and Fall Time (Note 2) 'ACT Devices except Schmitt Inputs	V _{CC} @ 4.5 V		10		ns/V
		V _{CC} @ 5.5 V		8.0		
T _J	Junction Temperature (PDIP)			140	°C	
T _A	Operating Ambient Temperature Range	-40	25	85	°C	
I _{OH}	Output Current — HIGH			-24	mA	
I _{OL}	Output Current — LOW			24	mA	

1. V_{in} from 30% to 70% V_{CC}; see individual Data Sheets for devices that differ from the typical input rise and fall times.

2. V_{in} from 0.8 V to 2.0 V; see individual Data Sheets for devices that differ from the typical input rise and fall times.

MC74AC823 MC74ACT823

DC CHARACTERISTICS

Symbol	Parameter	V _{CC} (V)	74AC		74AC		Unit	Conditions
			T _A = +25°C		T _A = -40°C to +85°C			
			Typ	Guaranteed Limits				
V _{IH}	Minimum High Level Input Voltage	3.0	1.5	2.1	2.1		V	V _{OUT} = 0.1 V or V _{CC} - 0.1 V
		4.5	2.25	3.15	3.15			
		5.5	2.75	3.85	3.85			
V _{IL}	Maximum Low Level Input Voltage	3.0	1.5	0.9	0.9		V	V _{OUT} = 0.1 V or V _{CC} - 0.1 V
		4.5	2.25	1.35	1.35			
		5.5	2.75	1.65	1.65			
V _{OH}	Minimum High Level Output Voltage	3.0	2.99	2.9	2.9		V	I _{OUT} = - 50 μA
		4.5	4.49	4.4	4.4			
		5.5	5.49	5.4	5.4			
		3.0		2.56	2.46		V	*V _{IN} = V _{IL} or V _{IH} - 12 mA I _{OH} - 24 mA - 24 mA
		4.5		3.86	3.76			
		5.5		4.86	4.76			
V _{OL}	Maximum Low Level Output Voltage	3.0	0.002	0.1	0.1		V	I _{OUT} = 50 μA
		4.5	0.001	0.1	0.1			
		5.5	0.001	0.1	0.1			
		3.0		0.36	0.44		V	*V _{IN} = V _{IL} or V _{IH} 12 mA I _{OH} 24 mA 24 mA
		4.5		0.36	0.44			
		5.5		0.36	0.44			
I _{IN}	Maximum Input Leakage Current	5.5		±0.1	±1.0		μA	V _I = V _{CC} , GND
I _{OZ}	Maximum 3-State Current	5.5		±0.5	±5.0		μA	V _I (OE) = V _{IL} , V _{IH} V _I = V _{CC} , GND V _O = V _{CC} , GND
I _{OLD}	†Minimum Dynamic Output Current	5.5			75		mA	V _{OLD} = 1.65 V Max
I _{OHD}		5.5			-75		mA	V _{OHD} = 3.85 V Min
I _{CC}	Maximum Quiescent Supply Current	5.5		8.0	80		μA	V _{IN} = V _{CC} or GND

* All outputs loaded; thresholds on input associated with output under test.

† Maximum test duration 2.0 ms, one input loaded at a time.

Note: I_{IN} and I_{CC} @ 3.0 V are guaranteed to be less than or equal to the respective limit @ 5.5 V V_{CC}.

MC74AC823 MC74ACT823

AC CHARACTERISTICS

Symbol	Parameter	V _{CC} * (V)	74AC			74AC		Unit	Fig. No.
			T _A = +25°C C _L = 50 pF			T _A = -40°C to +85°C C _L = 50 pF			
			Min	Typ	Max	Min	Max		
f _{max}	Maximum Clock Frequency	3.3 5.0						MHz	
t _{PLH}	Propagation Delay CP to Q _n	3.3 5.0						ns	
t _{PHL}	Propagation Delay CP to Q _n	3.3 5.0						ns	
t _{PHL}	Propagation Delay CLR to O _n	3.3 5.0						ns	
t _{PZH}	Output Enable Time OE to O _n	3.3 5.0						ns	
t _{PZL}	Output Enable Time OE to O _n	3.3 5.0						ns	
t _{PHZ}	Output Disable Time OE to O _n	3.3 5.0						ns	
t _{PLZ}	Output Disable Time OE to O _n	3.3 5.0						ns	

* Voltage Range 3.3 V is 3.3 V ±0.3 V.
Voltage Range 5.0 V is 5.0 V ±0.5 V.

AC OPERATING REQUIREMENTS

Symbol	Parameter	V _{CC} * (V)	74AC		74AC		Unit	Fig. No.
			T _A = +25°C C _L = 50 pF		T _A = -40°C to +85°C C _L = 50 pF			
			Typ	Guaranteed Minimum				
t _s	Set-up Time, HIGH or LOW D _n to CP	3.3 5.0					ns	
t _h	Hold Time, HIGH or LOW D _n to CP	3.3 5.0					ns	
t _s	Set-up Time, HIGH or LOW EN to CP	3.3 5.0					ns	
t _h	Hold Time, HIGH or LOW EN to CP	3.3 5.0					ns	
t _w	CP Pulse Width HIGH or LOW	3.3 5.0					ns	
t _w	CLR Pulse Width, LOW	3.3 5.0					ns	
t _{rec}	CLR to CP Recovery Time	3.3 5.0					ns	

* Voltage Range 3.3 V is 3.3 V ±0.3 V.
Voltage Range 5.0 V is 5.0 V ±0.5 V.

MC74AC823 MC74ACT823

DC CHARACTERISTICS

Symbol	Parameter	V _{CC} (V)	74ACT		74ACT		Unit	Conditions
			T _A = +25°C		T _A = -40°C to +85°C			
			Typ	Guaranteed Limits				
V _{IH}	Minimum High Level Input Voltage	4.5	1.5	2.0	2.0	V	V _{OUT} = 0.1 V or V _{CC} - 0.1 V	
		5.5	1.5	2.0	2.0			
V _{IL}	Maximum Low Level Input Voltage	4.5	1.5	0.8	0.8	V	V _{OUT} = 0.1 V or V _{CC} - 0.1 V	
		5.5	1.5	0.8	0.8			
V _{OH}	Minimum High Level Output Voltage	4.5	4.49	4.4	4.4	V	I _{OUT} = -50 μA	
		5.5	5.49	5.4	5.4			
		4.5		3.86	3.76	V	*V _{IN} = V _{IL} or V _{IH} - 24 mA I _{OH} - 24 mA	
5.5		4.86	4.76					
V _{OL}	Maximum Low Level Output Voltage	4.5	0.001	0.1	0.1	V	I _{OUT} = 50 μA	
		5.5	0.001	0.1	0.1			
		4.5		0.36	0.44	V	*V _{IN} = V _{IL} or V _{IH} 24 mA I _{OH} 24 mA	
5.5		0.36	0.44					
I _{IN}	Maximum Input Leakage Current	5.5		±0.1	±1.0	μA	V _I = V _{CC} , GND	
I _{OZ}	Maximum 3-State Current	5.5		±0.5	±5.0	μA	V _I (OE) = V _{IL} , V _{IH} V _I = V _{CC} , GND V _O = V _{CC} , GND	
ΔI _{CC} T	Additional Max. I _{CC} /Input	5.5	0.6		1.5			
I _{OLD}	†Minimum Dynamic Output Current	5.5			75	mA	V _{OLD} = 1.65 V Max	
I _{OHD}		5.5			-75	mA	V _{OHD} = 3.85 V Min	
I _{CC}	Maximum Quiescent Supply Current	5.5		8.0	80	μA	V _{IN} = V _{CC} or GND	

* All outputs loaded; thresholds on input associated with output under test.

† Maximum test duration 2.0 ms, one input loaded at a time.

MC74AC823 MC74ACT823

AC CHARACTERISTICS (For Figures and Waveforms — See Section 3)

Symbol	Parameter	V _{CC} * (V)	74ACT			74ACT		Unit	Fig. No.
			T _A = +25°C C _L = 50 pF			T _A = -40°C to +85°C C _L = 50 pF			
			Min	Typ	Max	Min	Max		
f _{max}	Maximum Clock Frequency	5.0	120	158		109		MHz	
t _{PLH}	Propagation Delay CP to Q _n	5.0	1.5	5.5	9.5	1.5	10.5	ns	
t _{PHL}	Propagation Delay CP to Q _n	5.0	2.0	5.5	9.5	1.5	10.5	ns	
t _{PHL}	Propagation Delay CLR to O _n	5.0	2.5	8.0	13.5	2.0	15.5	ns	
t _{PZH}	Output Enable Time OE to O _n	5.0	1.5	6.0	10.5	1.5	11.5	ns	
t _{PZL}	Output Enable Time OE to O _n	5.0	2.0	6.5	11.0	1.5	12.0	ns	
t _{PHZ}	Output Disable Time OE to O _n	5.0	1.5	6.5	11.0	1.5	12.0	ns	
t _{PLZ}	Output Disable Time OE to O _n	5.0	1.5	6.0	10.5	1.5	11.5	ns	

* Voltage Range 5.0 V is 5.0 V ±0.5 V.

AC OPERATING REQUIREMENTS

Symbol	Parameter	V _{CC} * (V)	74ACT		74ACT		Unit	Fig. No.
			T _A = +25°C C _L = 50 pF		T _A = -40°C to +85°C C _L = 50 pF			
			Typ	Guaranteed Minimum				
t _s	Set-up Time, HIGH or LOW D _n to CP	5.0	0.5	2.5	2.5	ns		
t _h	Hold Time, HIGH or LOW D _n to CP	5.0	0	2.5	2.5	ns		
t _s	Set-up Time, HIGH or LOW EN to CP	5.0	0	2.0	2.5	ns		
t _h	Hold Time, HIGH or LOW EN to CP	5.0	0	1.0	1.0	ns		
t _w	CP Pulse Width, HIGH or LOW	5.0	2.5	4.5	5.5	ns		
t _w	CLR Pulse Width, LOW	5.0	3.0	5.5	5.5	ns		
t _{rec}	CLR to CP Recovery Time	5.0	1.5	3.5	4.0	ns		

* Voltage Range 5.0 V is 5.0 V ±0.5 V.

CAPACITANCE

Symbol	Parameter	Value Typ	Unit	Test Conditions
C _{IN}	Input Capacitance	4.5	pF	V _{CC} = 5.0 V
C _{PD}	Power Dissipation Capacitance	44.0	pF	V _{CC} = 5.0 V

MC74AC823 MC74ACT823

OUTLINE DIMENSIONS

N SUFFIX PLASTIC DIP PACKAGE CASE 724-03 ISSUE D

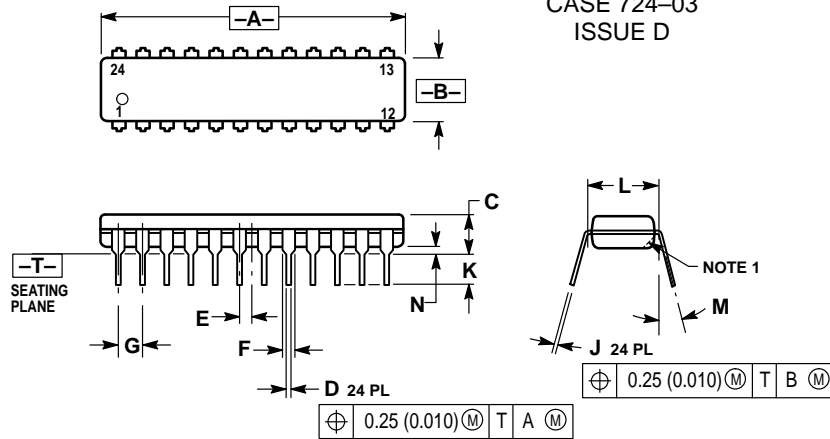

- NOTES:
1. CHAMFERED CONTOUR OPTIONAL.
 2. DIMENSION L TO CENTER OF LEADS WHEN FORMED PARALLEL.
 3. DIMENSIONING AND TOLERANCING PER ANSI Y14.5M, 1982.
 4. CONTROLLING DIMENSION: INCH.

DW SUFFIX PLASTIC SOIC PACKAGE CASE 751E-04 ISSUE E

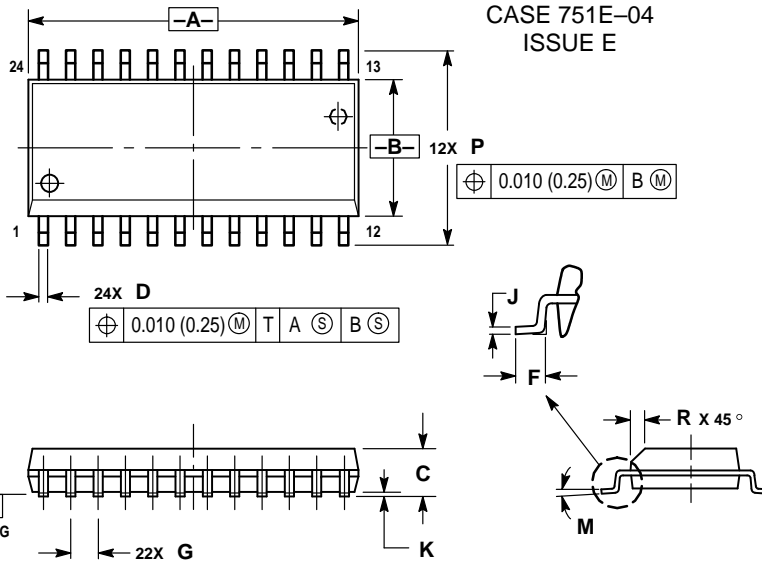

- NOTES:
1. DIMENSIONING AND TOLERANCING PER ANSI Y14.5M, 1982.
 2. CONTROLLING DIMENSION: MILLIMETER.
 3. DIMENSIONS A AND B DO NOT INCLUDE MOLD PROTRUSION.
 4. MAXIMUM MOLD PROTRUSION 0.15 (0.006) PER SIDE.
 5. DIMENSION D DOES NOT INCLUDE DAMBAR PROTRUSION. ALLOWABLE DAMBAR PROTRUSION SHALL BE 0.13 (0.005) TOTAL IN EXCESS OF D DIMENSION AT MAXIMUM MATERIAL CONDITION.

Motorola reserves the right to make changes without further notice to any products herein. Motorola makes no warranty, representation or guarantee regarding the suitability of its products for any particular purpose, nor does Motorola assume any liability arising out of the application or use of any product or circuit, and specifically disclaims any and all liability, including without limitation consequential or incidental damages. "Typical" parameters can and do vary in different applications. All operating parameters, including "Typicals" must be validated for each customer application by customer's technical experts. Motorola does not convey any license under its patent rights nor the rights of others. Motorola products are not designed, intended, or authorized for use as components in systems intended for surgical implant into the body, or other applications intended to support or sustain life, or for any other application in which the failure of the Motorola product could create a situation where personal injury or death may occur. Should Buyer purchase or use Motorola products for any such unintended or unauthorized application, Buyer shall indemnify and hold Motorola and its officers, employees, subsidiaries, affiliates, and distributors harmless against all claims, costs, damages, and expenses, and reasonable attorney fees arising out of, directly or indirectly, any claim of personal injury or death associated with such unintended or unauthorized use, even if such claim alleges that Motorola was negligent regarding the design or manufacture of the part. Motorola and  are registered trademarks of Motorola, Inc. Motorola, Inc. is an Equal Opportunity/Affirmative Action Employer.

How to reach us:

USA/EUROPE: Motorola Literature Distribution;
P.O. Box 20912; Phoenix, Arizona 85036. 1-800-441-2447

JAPAN: Nippon Motorola Ltd.; Tatsumi-SPD-JLDC, Toshikatsu Otsuki,
6F Seibu-Butsuryu-Center, 3-14-2 Tatsumi Koto-Ku, Tokyo 135, Japan. 03-3521-8315

MFAX: RMFAX0@email.sps.mot.com -TOUCHTONE (602) 244-6609
INTERNET: <http://Design-NET.com>

HONG KONG: Motorola Semiconductors H.K. Ltd.; 8B Tai Ping Industrial Park,
51 Ting Kok Road, Tai Po, N.T., Hong Kong. 852-26629298



MC74AC823/D

