

HFA180NH40R

HEXFRED™

Ultrafast, Soft Recovery Diode

Features

- Reduced RFI and EMI
- Reduced Snubbing
- Extensive Characterization of Recovery Parameters

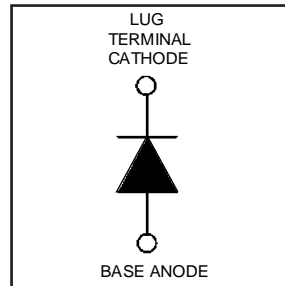

$V_R = 400V$
$V_F(\text{typ.})^{\textcircled{3}} = 1.1V$
$I_{F(AV)} = 180A$
$Q_{rr}(\text{typ.}) = 420nC$
$I_{RRM}(\text{typ.}) = 8.7A$
$t_{rr}(\text{typ.}) = 45ns$
$di_{(rec)M}/dt(\text{typ.})^{\textcircled{3}} = 280A/\mu s$

Description

HEXFRED™ diodes are optimized to reduce losses and EMI/RFI in high frequency power conditioning systems. An extensive characterization of the recovery behavior for different values of current, temperature and di/dt simplifies the calculations of losses in the operating conditions. The softness of the recovery eliminates the need for a snubber in most applications. These devices are ideally suited for power converters, motors drives and other applications where switching losses are significant portion of the total losses.

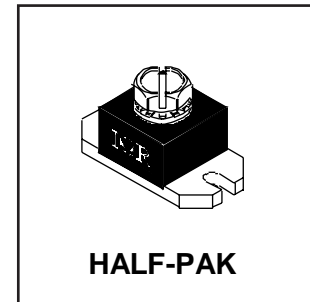

Absolute Maximum Ratings (per Leg)

	Parameter	Max.	Units
V_R	Cathode-to-Anode Voltage	400	V
$I_F @ T_C = 25^\circ C$	Continuous Forward Current	280	A
$I_F @ T_C = 100^\circ C$	Continuous Forward Current	138	
I_{FSM}	Single Pulse Forward Current ^①	1200	
E_{AS}	Non-Repetitive Avalanche Energy ^②	1.4	mJ
$P_D @ T_C = 25^\circ C$	Maximum Power Dissipation	521	W
$P_D @ T_C = 100^\circ C$	Maximum Power Dissipation	208	
T_J T_{STG}	Operating Junction and Storage Temperature Range	-55 to +150	°C

Thermal - Mechanical Characteristics

	Parameter	Min.	Typ.	Max.	Units
R_{thJC}	Junction-to-Case	—	—	0.20	°C/W
R_{thCS}	Case-to-Sink, Flat, Greased Surface	—	0.15	—	K/W
Wt	Weight	—	26 (0.9)	—	g (oz)
	Mounting Torque ^④	15 (1.7)	—	25 (2.8)	lbf·in
	Terminal Torque	30 (3.4)	—	40 (4.6)	(N·m)
	Vertical Pull	—	—	80	lbf·in
	2 inch Lever Pull	—	—	40	

Note: ^① Limited by junction temperature
^② L = 100μH, duty cycle limited by max T_J
^③ 125°C

^④ Mounting surface must be smooth, flat, free of burrs or other protrusions. Apply a thin even film of thermal grease to mounting surface. Gradually tighten each mounting bolt in 5-10 lbf·in steps until desired or maximum torque limits are reached. Module

HFA180NH40R

PD-2.451 rev. B 03/99

International
IOR Rectifier

Electrical Characteristics (per Leg) @ $T_J = 25^\circ\text{C}$ (unless otherwise specified)

	Parameter	Min.	Typ.	Max.	Units	Test Conditions
V_{BR}	Cathode Anode Breakdown Voltage	400	—	—	V	$I_R = 100\mu\text{A}$
V_{FM}	Max Forward Voltage See Fig. 1	—	1.10	1.35	V	$I_F = 180\text{A}$
		—	1.40	1.65		$I_F = 360\text{A}$
		—	1.10	1.30		$I_F = 180\text{A}, T_J = 125^\circ\text{C}$
I_{RM}	Max Reverse Leakage Current See Fig. 2	—	2.0	12	μA	$V_R = V_R \text{ Rated}$
		—	3.0	16	mA	$T_J = 125^\circ\text{C}, V_R = 320\text{V}$
C_T	Junction Capacitance See Fig. 3	—	370	500	pF	$V_R = 200\text{V}$
L_S	Series Inductance	—	5.0	—	nH	From top of terminal hole to mounting plane

Dynamic Recovery Characteristics (per Leg) @ $T_J = 25^\circ\text{C}$ (unless otherwise specified)

	Parameter	Min.	Typ.	Max.	Units	Test Conditions	
t_{rr}	Reverse Recovery Time	—	45	—	ns	$I_F = 1.0\text{A}, di_f/dt = 200\text{A}/\mu\text{s}, V_R = 30\text{V}$ $T_J = 25^\circ\text{C}$	
t_{rr1}	See Fig. 5	—	90	140			$T_J = 125^\circ\text{C}$
t_{rr2}		—	290	440			
I_{RRM1}	Peak Recovery Current	—	8.7	20	A	$T_J = 25^\circ\text{C}$ $T_J = 125^\circ\text{C}$	
I_{RRM2}	See Fig. 6	—	18	30			
Q_{rr1}	Reverse Recovery Charge	—	420	1100	nC	$T_J = 25^\circ\text{C}$ $T_J = 125^\circ\text{C}$	
Q_{rr2}	See Fig. 7	—	2600	7000			
$di_{(rec)M}/dt1$	Peak Rate of Fall of Recovery Current	—	300	—	$\text{A}/\mu\text{s}$	$T_J = 25^\circ\text{C}$ $T_J = 125^\circ\text{C}$	
$di_{(rec)M}/dt2$	During t_b See Fig. 8	—	280	—			

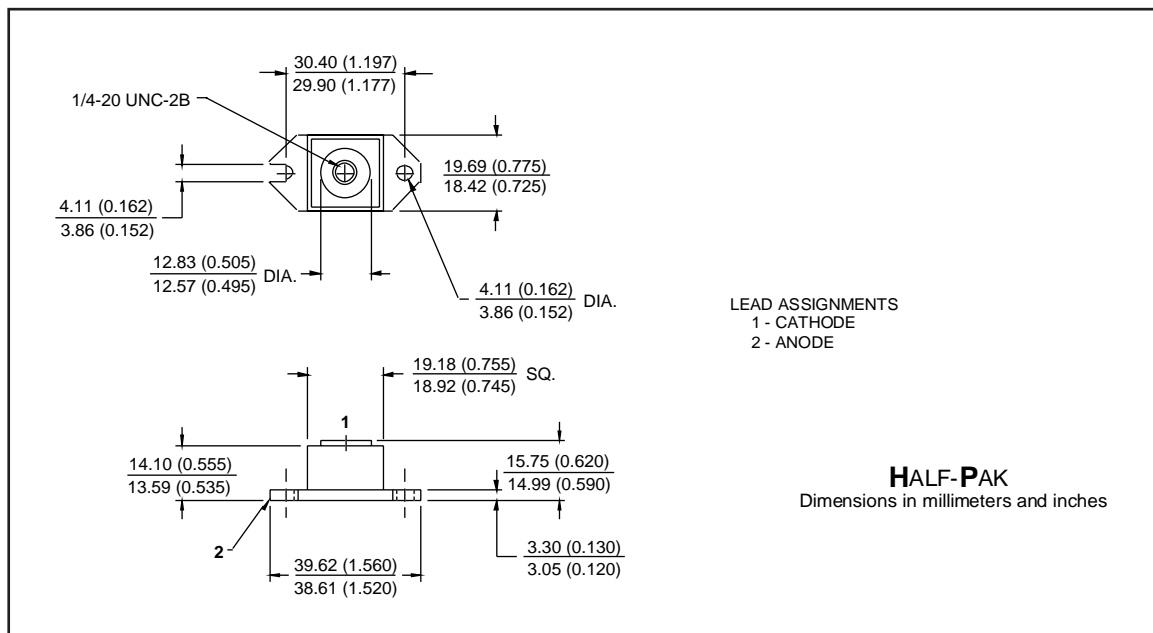

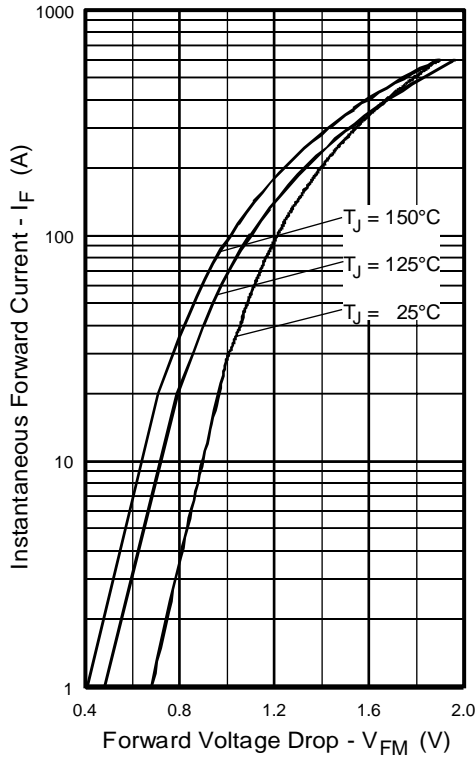

Fig. 1 - Maximum Forward Voltage Drop vs. Instantaneous Forward Current

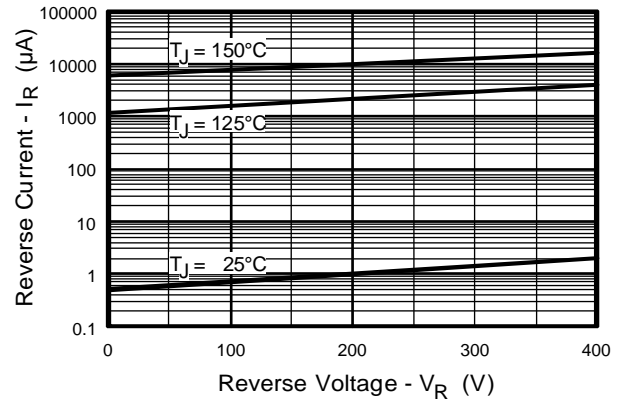

Fig. 2 - Typical Reverse Current vs. Reverse Voltage

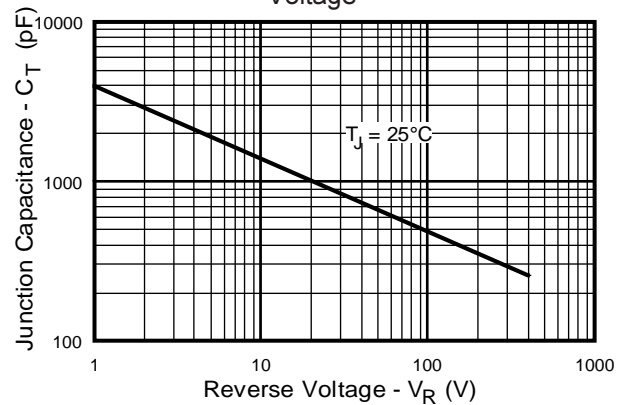

Fig. 3 - Typical Junction Capacitance vs. Reverse Voltage

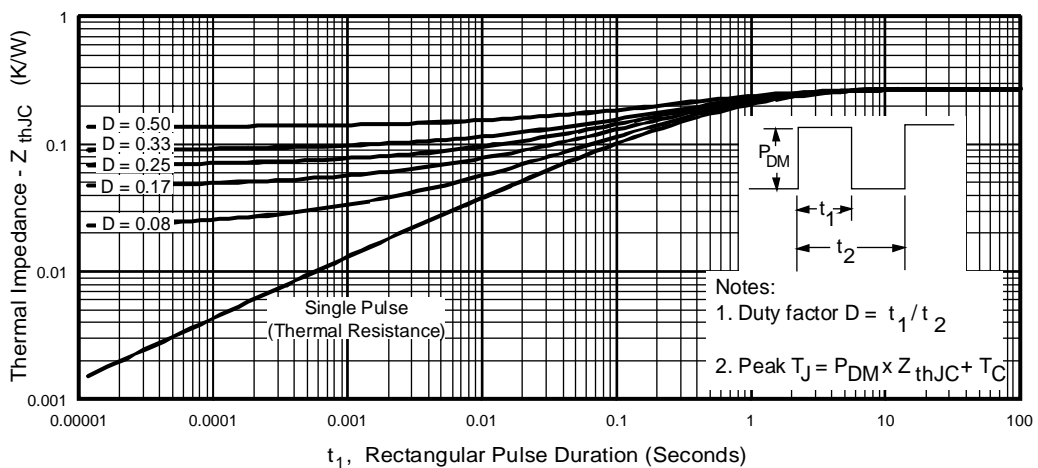

Fig. 4 - Maximum Thermal Impedance Z_{thJC} Characteristics

HFA180NH40R

PD-2.451 rev. B 03/99

International
IOR Rectifier

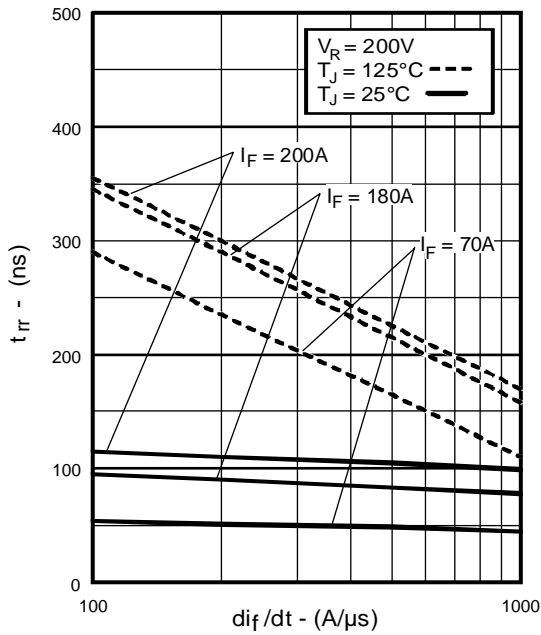

Fig. 5 - Typical Reverse Recovery vs. di_f/dt

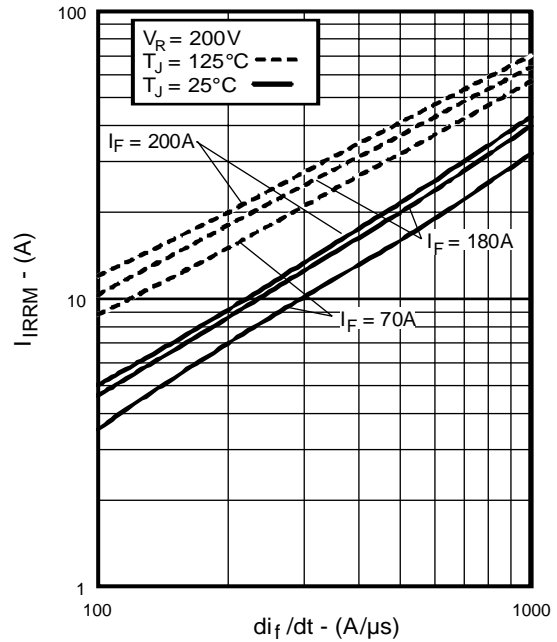

Fig. 6 - Typical Recovery Current vs. di_f/dt

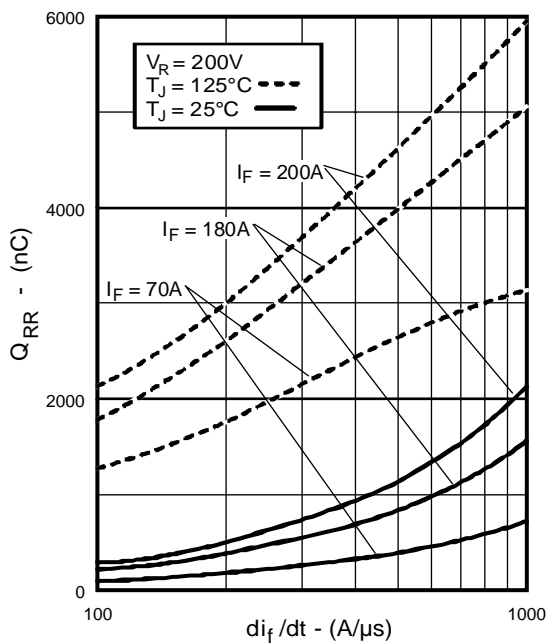

Fig. 7 - Typical Stored Charge vs. di_f/dt

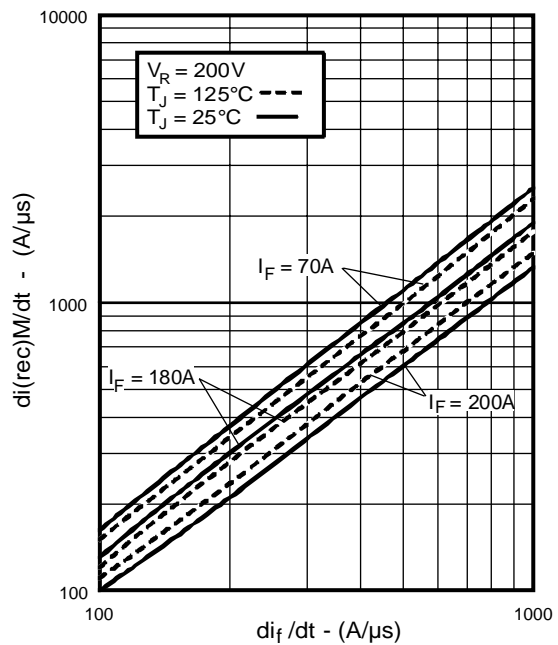

Fig. 8 - Typical $di_{(rec)M}/dt$ vs. di_f/dt

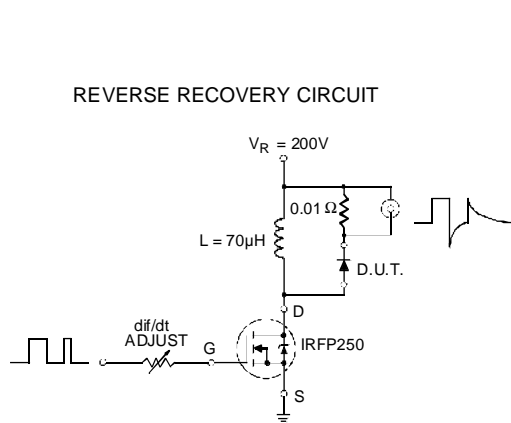

Fig. 9 - Reverse Recovery Parameter Test Circuit

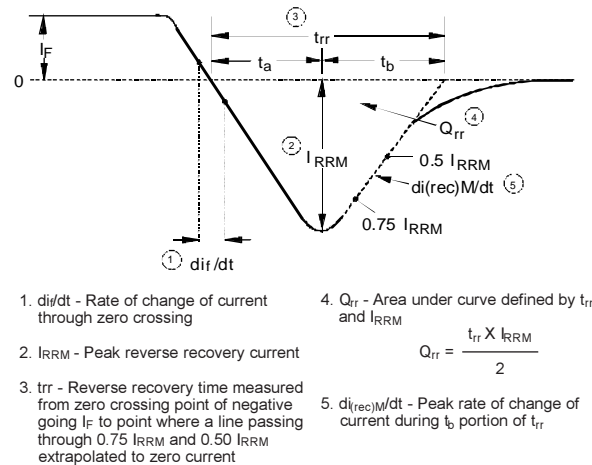

Fig. 10 - Reverse Recovery Waveform and Definitions

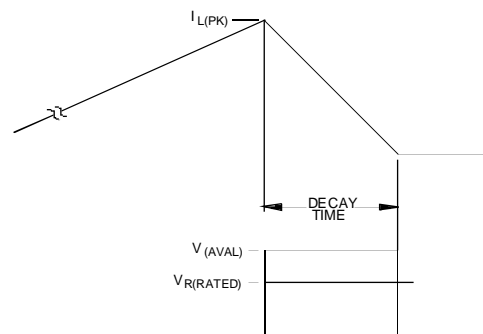
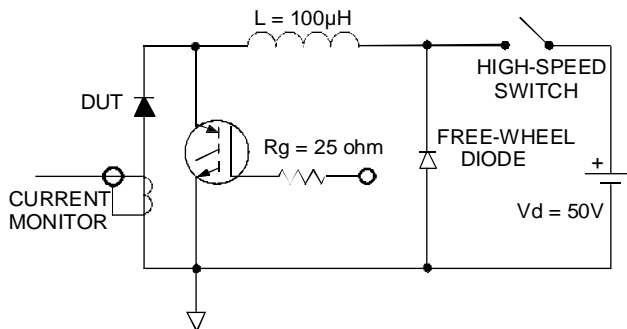

Fig. 11 - Avalanche Test Circuit and Waveforms