

SWITCHING REGULATOR CONTROL IC FOR FLYBACK

■GENERAL DESCRIPTION

The **NJM2369** is a high speed switching regulator control IC which can operate at low voltage.

It uses a totempole output circuit, so that it can drive an external power MOS-FET directly.

It is suitable for applications of flyback type switching regulation of up to 10W.

■PACKAGE OUTLINE

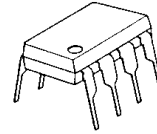

NJM2369D

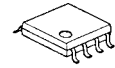

NJM2369M

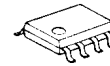

NJM2369E



NJM2369V

■FEATURES

- Operating Voltage (3.6V ~ 32V)
- Wide Oscillator Range (5kHz ~ 350 kHz)
- Soft-Start function.
- Under Voltage Lockouts (U.V.L.O.)
- Bipolar Technology
- Package Outline DIP8, DMP8, EMP8, SSOP8

■BLOCK DIAGRAM

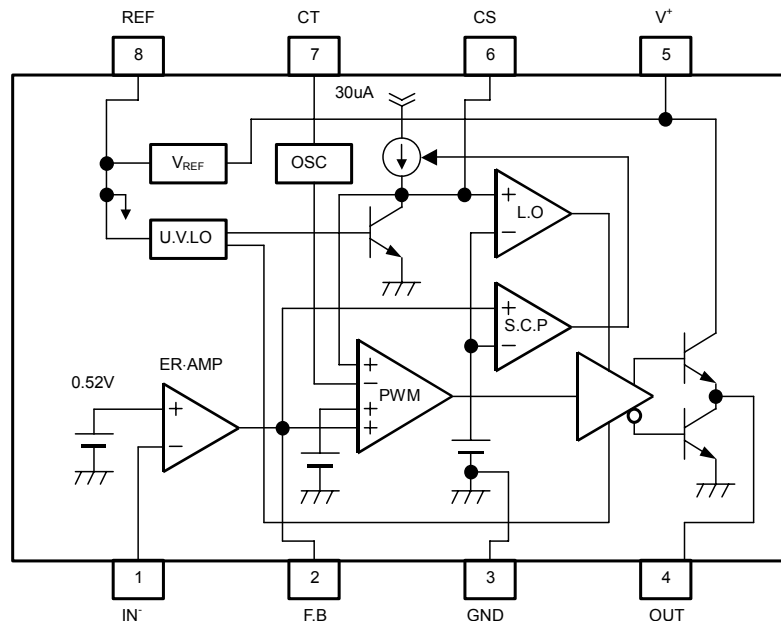

PIN FUNCTION

1. IN⁻
2. F.B
3. GND
4. OUT
5. V⁺
6. CS
7. CT
8. REF

NJM2369

■ABSOLUTE MAXIMUM RATINGS (Ta=25°C)

PARAMETER	SYMBOL	MAXIMUM RATINGS	UNIT
Input Voltage	V ⁺	36	V
Reference Output Current	I _{OR}	10	mA
Power Dissipation	P _D	(DIP 8) 700 (DMP 8) 300 (EMP 8) 300 (SSOP 8) 250	mW
Operating Temperature Range	T _{OPR}	-40 ~ +85	°C
Storage Temperature Range	T _{STG}	-50 ~ 125	°C

■RECOMMENDED OPERATING CONDITIONS (V⁺=6V, Ta=25°C)

PARAMETER	SYMBOL	RATINGS	MIN.	MAX.	UNIT
Operating Voltage	V ⁺		3.6	32	V
Feed Back Resistor	R _{NF}		100	—	kΩ
Oscillator Timing Capacitor	C _T		220	22,000	pF
Oscillator Timing Resistor	R _T		10	100	kΩ
Oscillate	f _{OSC}		5	350	kHz

■ELECTRICAL CHARACTERISTICS (V⁺=6V, R_T=33kΩ, C_T=1,000pF, Ta=25°C)

REFERENCE VOLTAGE BLOCK

PARAMETER	SYMBOL	RATINGS	MIN.	TYP.	MAX.	UNIT
Output Voltage	V _{REF}	I _{OR} =1mA	2.45	2.50	2.55	V
Line Regulation	L _{LINE}	V ⁺ =3.6V ~ 32V, I _{OR} =1mA	—	6.8	20.7	mV
Load Regulation	L _{LOAD}	I _{OR} =0.1mA ~ 5.0mA	—	5	30	mV

OSCILLATOR BLOCK

PARAMETER	SYMBOL	RATINGS	MIN.	TYP.	MAX.	UNIT
Oscillate	f _{osc}	C _T =1,000pF, R _T =33kΩ	85	105	125	kHz
Oscillate Fluctuations1 (Line Fluctuations)	f _{dv}	V ⁺ =3.6V ~ 32V	—	1	—	%
Oscillate Fluctuations2 (Temp Fluctuations)	f _{dt}	Ta=-40°C ~ +85°C	—	5	—	%

ERROR AMPLIFIER BLOCK

PARAMETER	SYMBOL	RATINGS	MIN.	TYP.	MAX.	UNIT
Reference Voltage	V _B		0.51	0.52	0.53	V
Input Bias Current	I _B		—	5	100	nA
Open Loop Gain	A _V		—	90	—	dB
Gain Band width Product	G _B		—	0.6	—	MHz
Maximum Output Voltage (F.B Pin)	V _{OM+} V _{OM-}	R _{NF} =100kΩ R _{NF} =100kΩ	V _{REF} -0.2	—	— 200	V mV
Output Source Current (F.B Pin)	I _{OM+}	V _{OM} =1V	40	85	200	uA

■ELECTRICAL CHARACTERISTICS ($V^+=6V$, $R_T=33k\Omega$, $C_T=1,000pF$, $T_a=25^\circ C$)

PWM COMPARATE BLOCK

PARAMETER	SYMBOL	RATINGS	MIN.	TYP.	MAX.	UNIT
Input Bias Voltage (F.B Pin)	V_{TH0}	duty cycle=0%	–	0.55	0.65	V
Input Threshold Voltage (F.B Pin)	V_{TH50}	duty cycle=50%	–	0.87	–	V
Maximum Duty Cycle	αM	F.B Pin=1.2V	55	64	85	%

SOFT START CIRCUIT BLOCK

PARAMETER	SYMBOL	RATINGS	MIN.	TYP.	MAX.	UNIT
Input Bias Current (CS Pin)	I_{BCS}		–	250	650	nA
Input Threshold Voltage (CS Pin)	V_{THCS0}	duty cycle=0%	–	0.25	0.35	V
Input Threshold Voltage (CS Pin)	V_{THCS50}	duty cycle=50%	–	0.52	–	V

SHORT CIRCUIT PROTECTION

PARAMETER	SYMBOL	RATINGS	MIN.	TYP.	MAX.	UNIT
Input Threshold Voltage (F.B Pin)	V_{THPC}		1.20	1.50	1.80	V
Charge Current (CS Pin)	I_{CHG}	CS Pin=0V, F.B Pin=2V	10	30	50	μA
Latch mode Threshold Voltage (CS Pin)	V_{THLA}		1.20	1.50	1.80	V

UNDER VOLTAGE LOCKOUT

PARAMETER	SYMBOL	RATINGS	MIN.	TYP.	MAX.	UNIT
ON Threshold Voltage	V_{THON}		–	2.70	–	V
OFF Threshold Voltage	V_{THOFF}		–	2.52	–	V
Hysteresis Voltage	V_{HYS}		60	180	–	mV

OUTPUT

PARAMETER	SYMBOL	RATINGS	MIN.	TYP.	MAX.	UNIT
H-Output Voltage (OUT Pin)	V_{OH}	$R_L=10k\Omega$	3.50	4.00	–	V
L-Output Voltage (OUT Pin)	V_{OL}	Output Sink Current =20mA	–	0.25	0.65	V
Output Source Current (OUT Pin)	I_{SOURCE}	OUT Pin=0V	–	35	–	mA

GENERAL CHARACTERISTIC

PARAMETER	SYMBOL	RATINGS	MIN.	TYP.	MAX.	UNIT
Quiescent Current	I_{CCLA}	Latch Mode	–	1.6	2.2	mA
Average Quiescent Current	I_{CCAV}	$R_L=\infty$, duty cycle=50%	–	5.2	10.0	mA

■ TYPICAL CHARACTERISTICS

H Output Voltage vs. Source Current
($V^+=6V$, $R_T=33k\Omega$, $C_T=1,000pF$, OUT Pin=0V, $T_a=25^\circ C$)

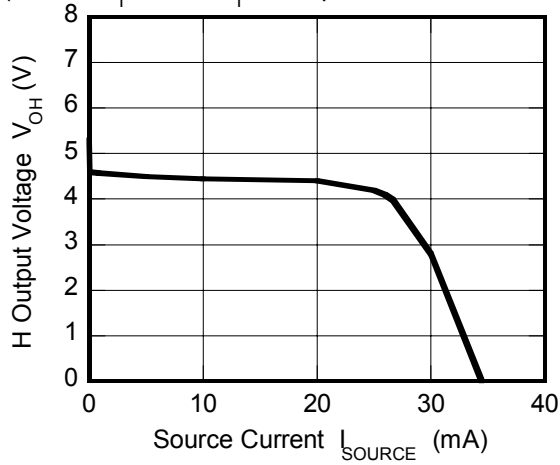

L Output Voltage vs. Sink Current
($V^+=6V$, $R_T=33k\Omega$, $C_T=1,000pF$, $T_a=25^\circ C$)

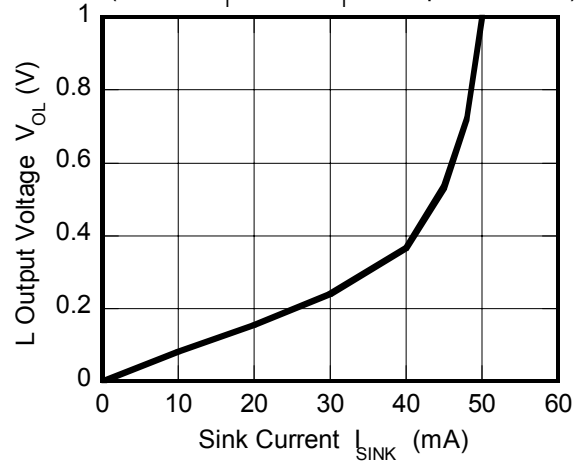

Oscillator Frequency vs. Timing Resistor
($V^+=6V$, $T_a=25^\circ C$)

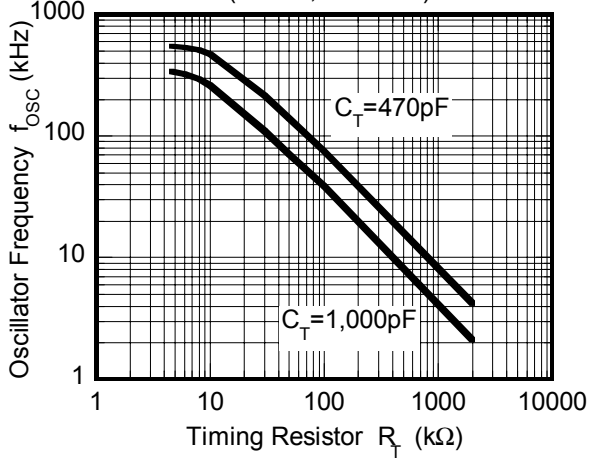

Oscillator Frequency vs. Timing Capacitor
($V^+=6V$, $T_a=25^\circ C$)

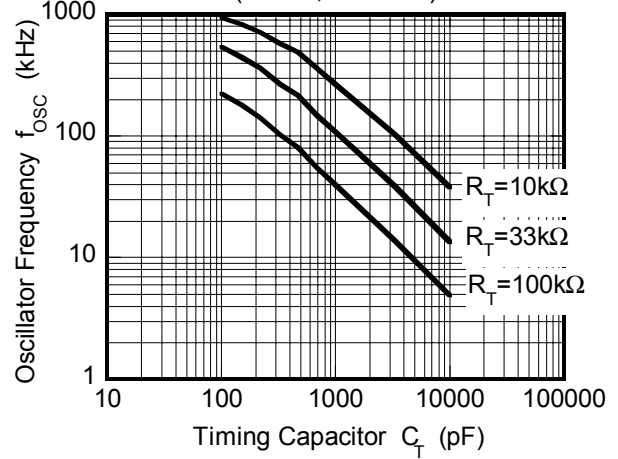

Reference Voltage vs. Operating Voltage
($V^+=6V$, $T_a=25^\circ C$)

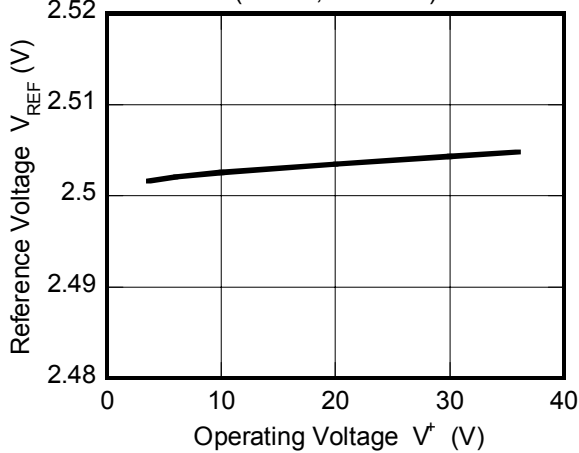

Operating Current vs. Operating Voltage
($T_a=25^\circ C$)

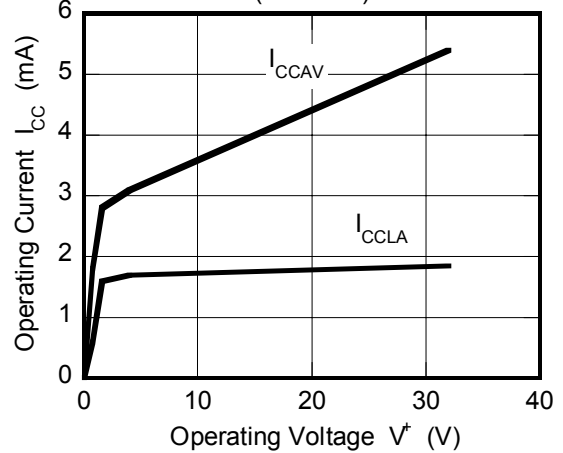

■ TYPICAL CHARACTERISTICS

Oscillator Frequency vs. Temperature

($V^+=6V$, $R_T=33k\Omega$, $C_T=1,000pF$)

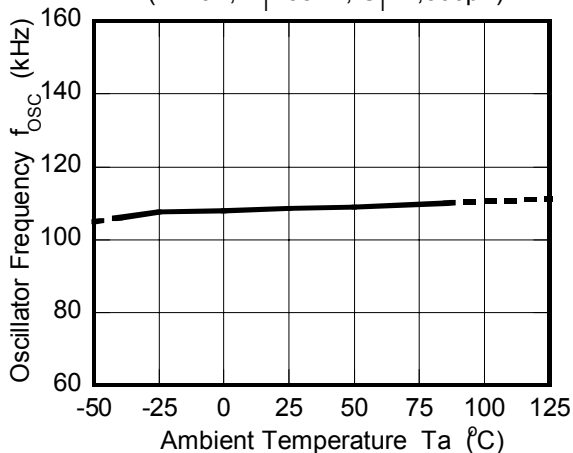

Reference Voltage vs. Temperature

($V^+=6V$, $I_{OR}=1mA$)

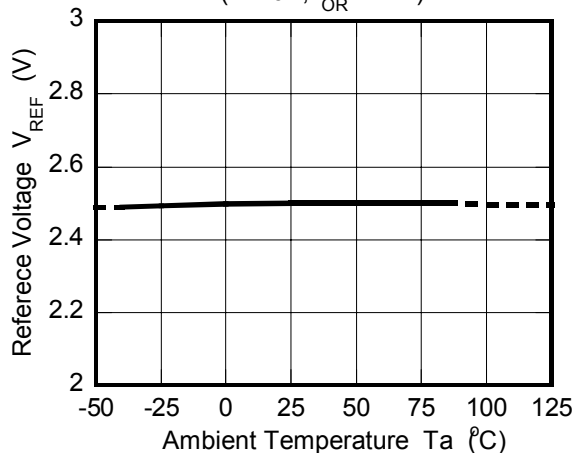

H Output Voltage vs. Temperature

($V^+=6V$, $R_L=10k\Omega$, $R_T=33k\Omega$, $C_T=1,000pF$)

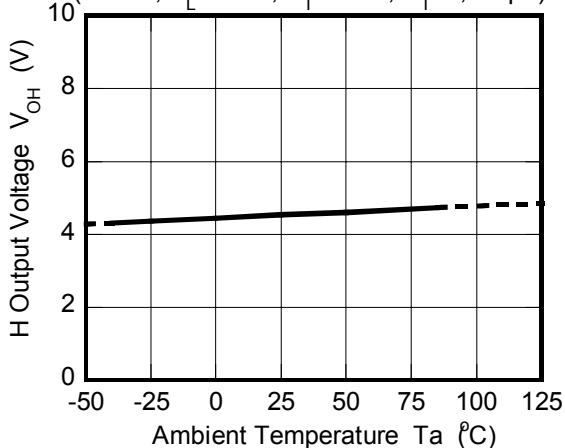

L Output Voltage vs. Temperature

($V^+=6V$, $I_{SINK}=20mA$, $R_T=33k\Omega$, $C_T=1,000pF$)

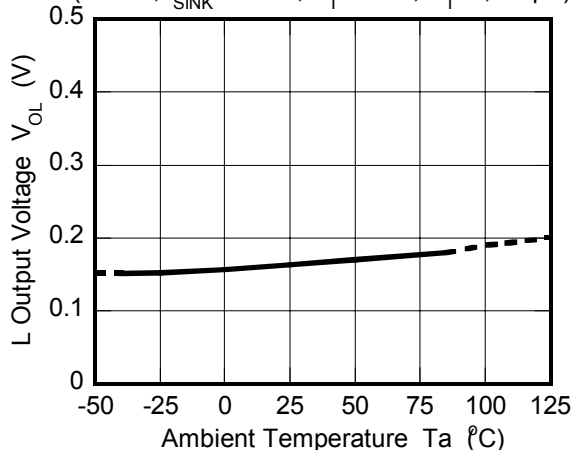

Quiescent Current vs. Temperature

(Latch Mode, $V^+=6V$, $R_T=33k\Omega$, $C_T=1,000pF$)

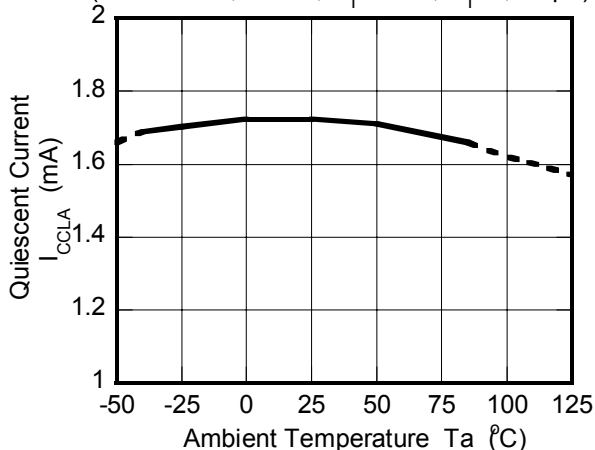

Average Quiescent Current vs. Temperature

($V^+=6V$, $R_L=\infty$, duty cycle=50%, $R_T=33k\Omega$, $C_T=1,000pF$)

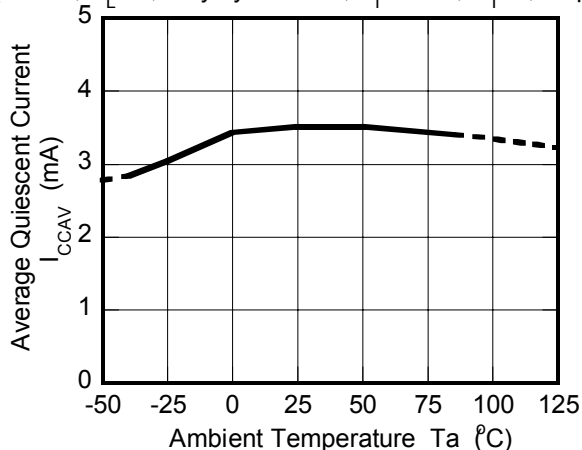

■ TYPICAL CHARACTERISTICS

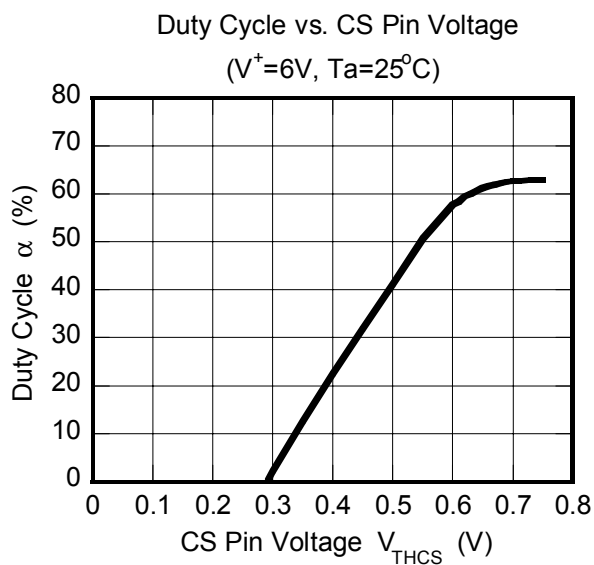
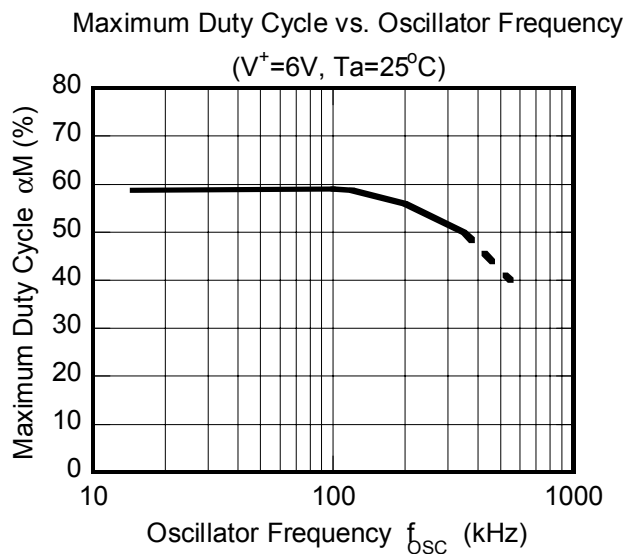

[CAUTION]

The specifications on this databook are only given for information, without any guarantee as regards either mistakes or omissions. The application circuits in this databook are described only to show representative usages of the product and not intended for the guarantee or permission of any right including the industrial rights.