

Major Ratings and Characteristics

Characteristics	SD51...	Units
$I_{F(AV)}$ Rectangular waveform	60	A
V_{RRM}	35/45	V
I_{FSM} @ 60Hz	800	A
V_F @ 120Apk, $T_J=150^\circ\text{C}$	0.75	V
T_J	-65 to 150	$^\circ\text{C}$

Description/Features

The SD51 Schottky rectifier has been optimized for very low forward voltage drop, with moderate leakage. The proprietary barrier technology allows for reliable operation up to 150° C junction temperature. Typical applications are in switching power supplies, converters, free-wheeling diodes, and reverse battery protection.

- 150° C T_J operation
- Very low forward voltage drop
- High frequency operation
- Guard ring for enhanced ruggedness and long term reliability
- Hermetic packaging

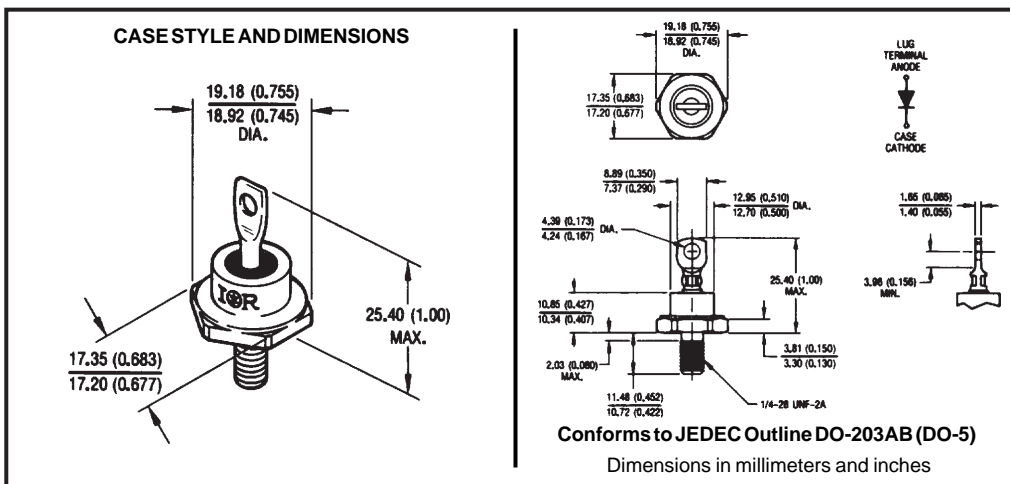

Voltage Ratings

Part number	SD51
V_R Max. DC Reverse Voltage (V)	35/45 (1)
V_{RWM} Max. Working Peak Reverse Voltage (V)	

(1) For SD51 V_{RWM} and $V_{RRM} = 45V @ T_J = 25^\circ C$, $=35V @ T_J = 150^\circ C$

Absolute Maximum Ratings

Parameters	SD51	Units	Conditions
$I_{F(AV)}$ Max. Average Forward Current * See Fig. 5	60	A	50% duty cycle @ $T_C = 90^\circ C$, rectangular waveform
I_{FSM} Max. Peak One Cycle Non-Repetitive Surge Current * See Fig. 7	800	A	60Hz half cycle sine wave or 5ms rectangular pulse Following any rated load condition and with rated V_{RRM} applied

Electrical Specifications

Parameters	SD51	Units	Conditions
V_{FM} Max. Forward Voltage Drop (2) * See Fig. 1	0.58	V	@ 35A $T_J = 25^\circ C$
	0.66	V	@ 60A
	0.86	V	@ 120A
	0.75	V	@ 120A $T_J = 150^\circ C$
I_{RM} Max. Reverse Leakage Current (2) * See Fig. 2	50	mA	$T_J = 25^\circ C$
	200	mA	$T_J = 125^\circ C$ $V_R = \text{rated } V_R$
C_T Max. Junction Capacitance	2900	pF	$V_R = 5V_{DC}$, (test signal range 100Khz to 1Mhz) $25^\circ C$
L_S Typical Series Inductance	7.5	nH	Measured from top of terminal to mounting plane
dv/dt Max. Voltage Rate of Change (Rated V_R)	1000	V/ μs	

(2) Pulse Width < 300 μs , Duty Cycle < 2%

Thermal-Mechanical Specifications

Parameters	SD51	Units	Conditions
T_J Max. Junction Temperature Range	-65 to 150	$^\circ C$	
T_{stg} Max. Storage Temperature Range	-65 to 150	$^\circ C$	
R_{thJC} Max. Thermal Resistance Junction to Case	1.0	$^\circ C/W$	DC operation * See Fig. 4
R_{thCS} Typical Thermal Resistance, Case to Heatsink	0.25	$^\circ C/W$	Mounting surface, smooth and greased
wt Approximate Weight	15(0.53)	g(oz.)	
T Mounting Torque	Min.	23(20)	Non-lubricated threads
	Max.	46(40)	
Case Style	DO-203AB(DO-5)	JEDEC	

* For Additional Informations and Graphs, Please See the 50HQ Series

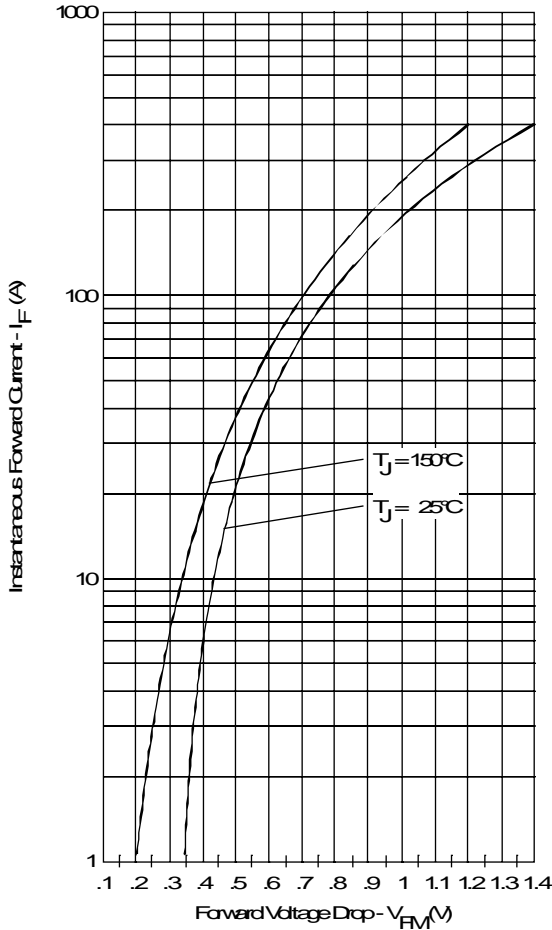

Fig. 1 - Maximum Forward Voltage Drop Characteristics

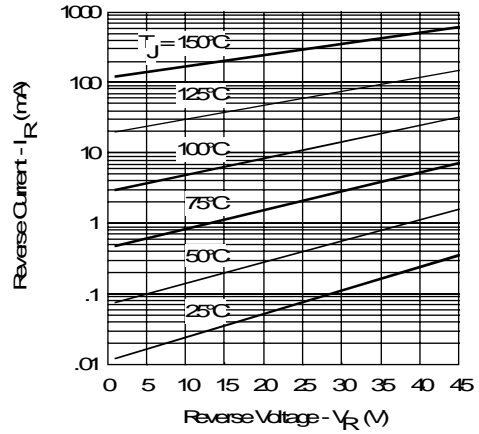

Fig. 2 - Typical Values of Reverse Current Vs. Reverse Voltage

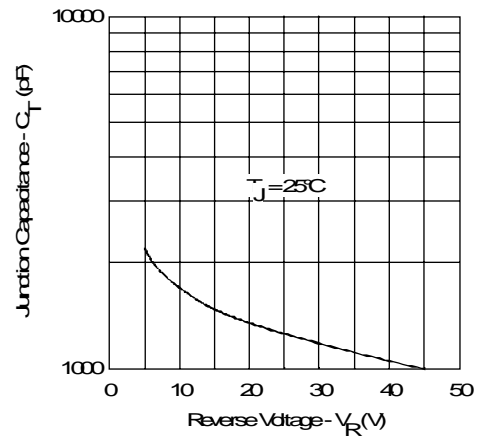

Fig. 3 - Typical Junction Capacitance Vs. Reverse Voltage

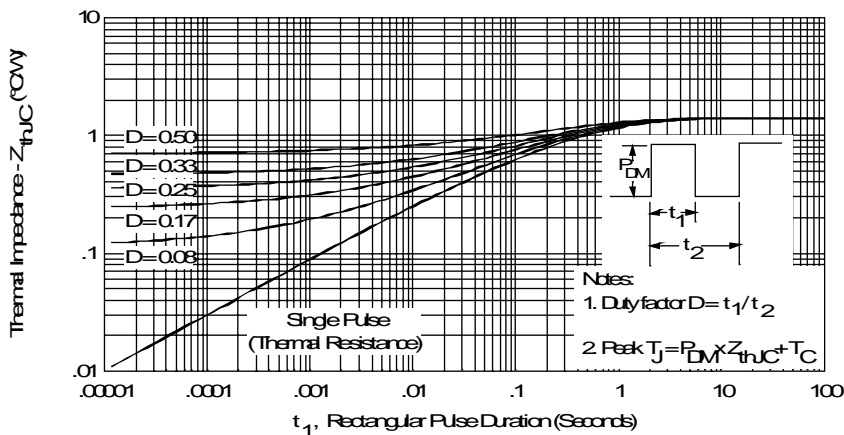

Fig. 4 - Maximum Thermal Impedance Z_{thJC} Characteristics

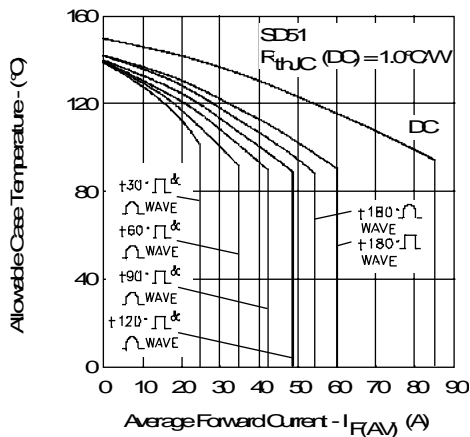

Fig. 5 - Maximum Allowable Case Temperature Vs. Average Forward Current

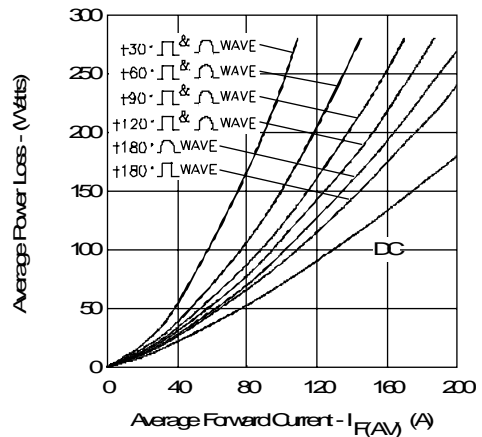

Fig. 6 - Forward Power Loss Characteristics

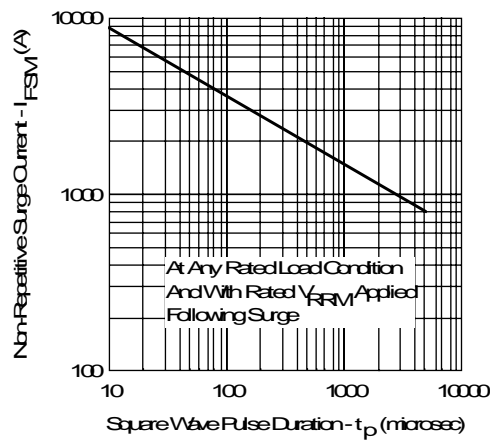

Fig. 7 - Max. Non-Repetitive Surge Current