



MJD122 MJD127

COMPLEMENTARY SILICON POWER DARLINGTON TRANSISTORS

- STMicroelectronics PREFERRED SALESTYPES
- LOW BASE-DRIVE REQUIREMENTS
- INTEGRATED ANTIPARALLEL COLLECTOR-EMITTER DIODE
- SURFACE-MOUNTING TO-252 (DPAK) POWER PACKAGE IN TAPE & REEL (SUFFIX "T4")
- ELECTRICAL SIMILAR TO TIP122 AND TIP127

APPLICATIONS

- GENERAL PURPOSE SWITCHING AND AMPLIFIER.

DESCRIPTION

The MJD122 and MJD127 form complementary NPN - PNP pairs.

They are manufactured using Epitaxial Base technology for cost-effective performance.

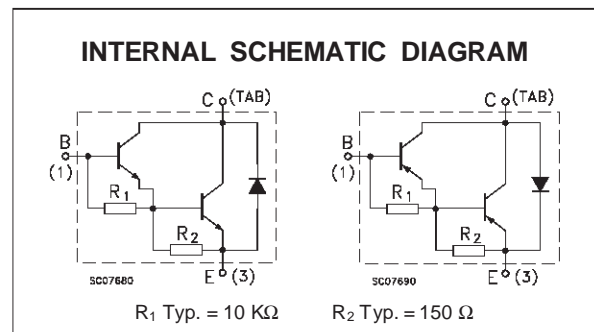
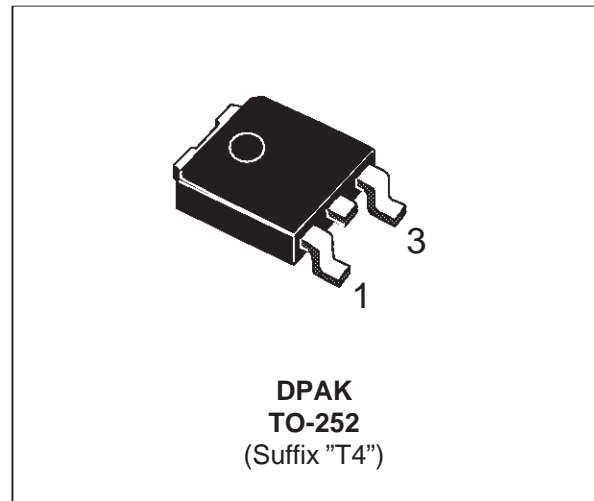

ABSOLUTE MAXIMUM RATINGS

Symbol	Parameter	Value		Unit
		NPN	MJD122	
		PNP	MJD127	
V_{CBO}	Collector-Base Voltage ($I_E = 0$)		100	V
V_{CEO}	Collector-Emitter Voltage ($I_B = 0$)		100	V
V_{EBO}	Emitter-Base Voltage ($I_C = 0$)		5	V
I_C	Collector Current		5	A
I_{CM}	Collector Peak Current		8	A
I_B	Base Current		100	mA
P_{tot}	Total Dissipation at $T_{case} \leq 25^\circ C$		20	W
T_{stg}	Storage Temperature		-65 to 150	$^\circ C$
T_j	Max. Operating Junction Temperature		150	$^\circ C$

For PNP types voltage and current values are negative.

MJD122 MJD127

THERMAL DATA

R _{thj-case}	Thermal Resistance Junction-case	Max	6.25	°C/W
R _{thj-amb}	Thermal Resistance Junction-ambient	Max	100	°C/W

ELECTRICAL CHARACTERISTICS (T_{case} = 25 °C unless otherwise specified)

Symbol	Parameter	Test Conditions	Min.	Typ.	Max.	Unit
I _{CBO}	Collector Cut-off Current (I _E = 0)	V _{CB} = 100 V			10	μA
I _{CEO}	Collector Cut-off Current (I _B = 0)	V _{CE} = 50 V			10	μA
I _{CEX}	Collector Cut-off Current	V _{CE} = 100 V V _{BE} = -1.5V V _{CE} = 100 V V _{BE} = -1.5V T _C = 125°C			10 500	μA μA
I _{EBO}	Emitter Cut-off Current (I _C = 0)	V _{EB} = 5 V			2	mA
V _{CEO(sus)}	Collector-Emitter Sustaining Voltage	I _C = 30 mA	100			V
V _{CE(sat)*}	Collector-Emitter Saturation Voltage	I _C = 4 A I _B = 16 mA I _C = 8 A I _B = 80 mA			2 4	V V
V _{BE(sat)*}	Base-Emitter Saturation Voltage	I _C = 8 A I _B = 80 mA			4.5	V
V _{BE(on)*}	Base-Emitter Voltage	I _C = 4 A V _{CE} = 4 V			2.8	V
h _{FE*}	DC Current Gain	I _C = 4 A V _{CE} = 4 V I _C = 8 A V _{CE} = 4 V	1000 100		12000	

* Pulsed: Pulse duration = 300 μs, duty cycle ≤ 2 %
For PNP type voltage and current values are negative.

Safe Operating Area

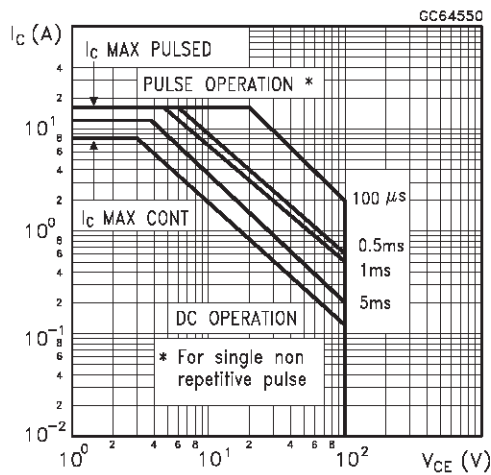

Derating Curve

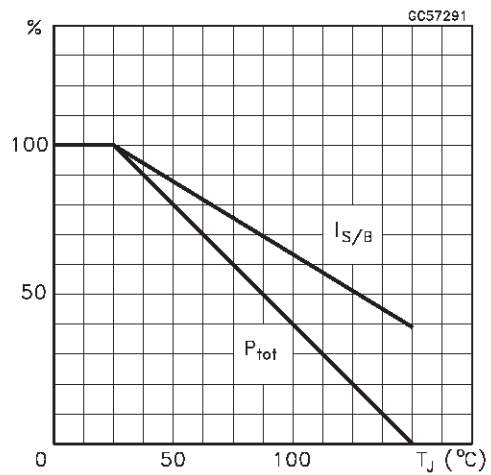

DC Current Gain (NPN type)

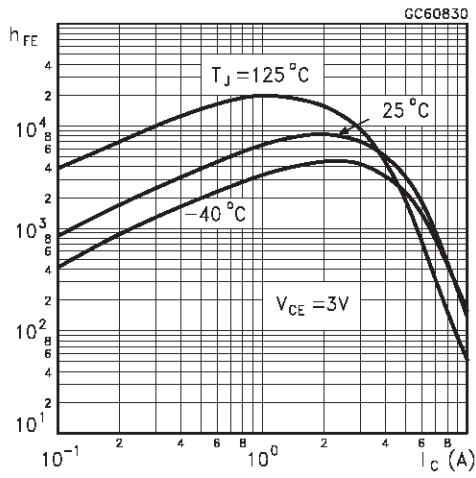

DC Current Gain (PNP type)

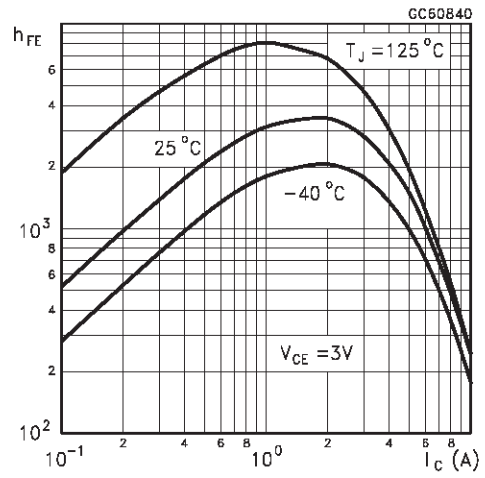

Collector Emitter Saturation Voltage (NPN type)

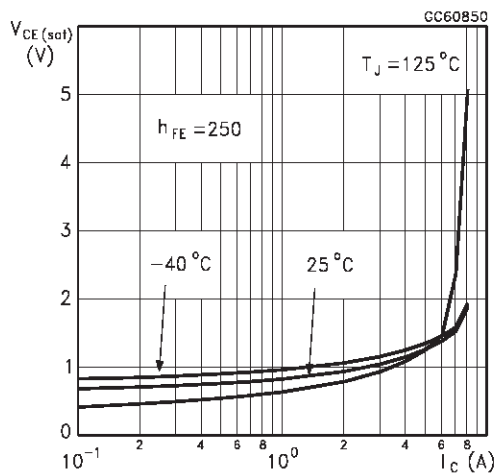

Collector Emitter Saturation Voltage (PNP type)

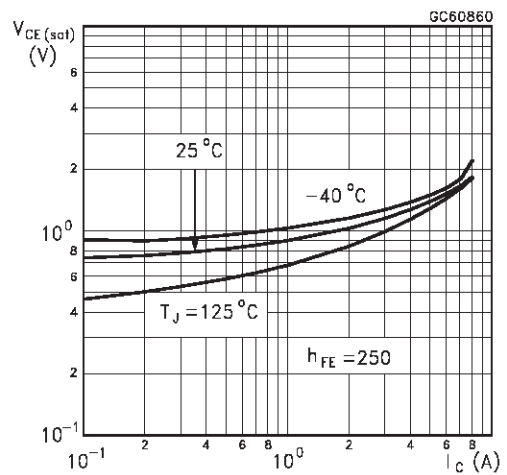

Base Emitter Saturation Voltage (NPN type)

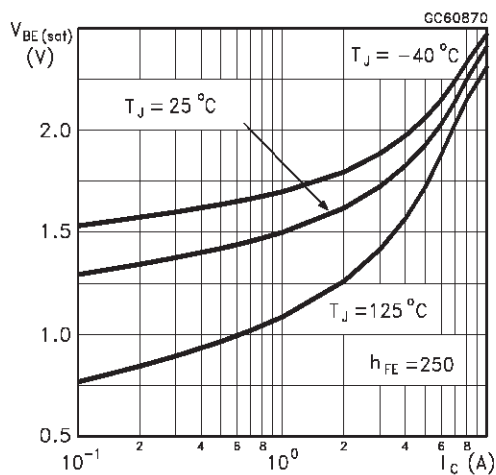

Base Emitter Saturation Voltage (PNP type)

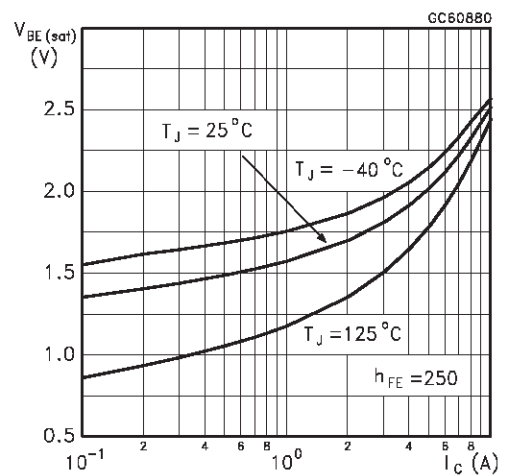

Base Emitter On Voltage (NPN type)

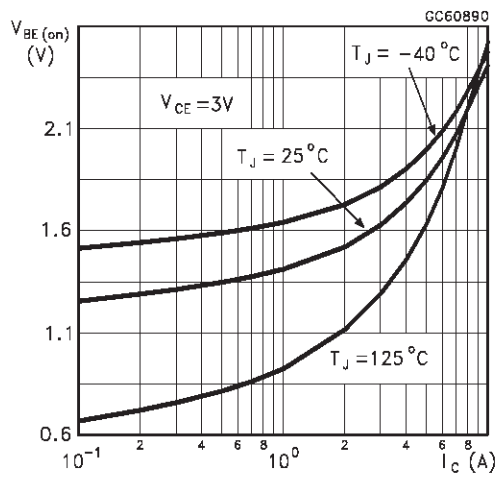

Base Emitter On Voltage (PNP type)

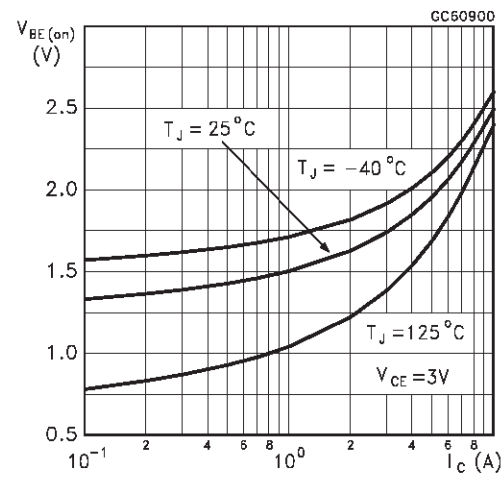

Freewheel Diode Forward Voltage (NPN type)

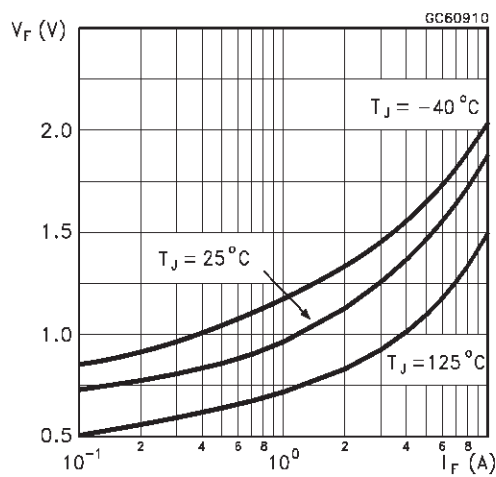

Freewheel Diode Forward Voltage (PNP type)

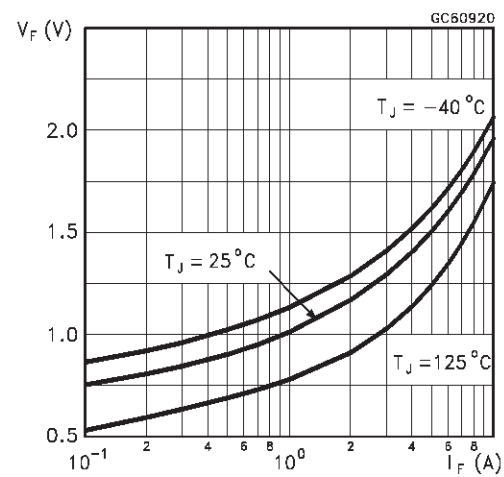

Switching Time Resistive Load (NPN type)

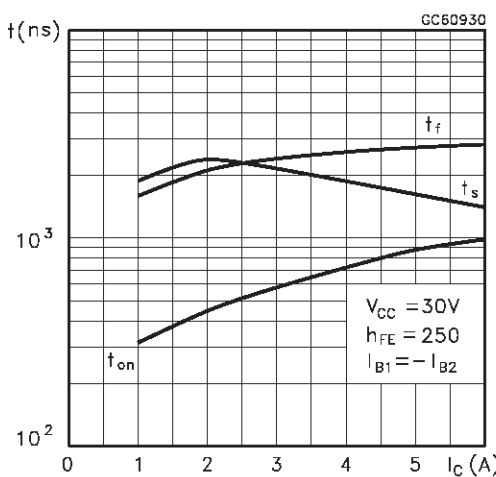

Switching Time resistive Load (PNP type)

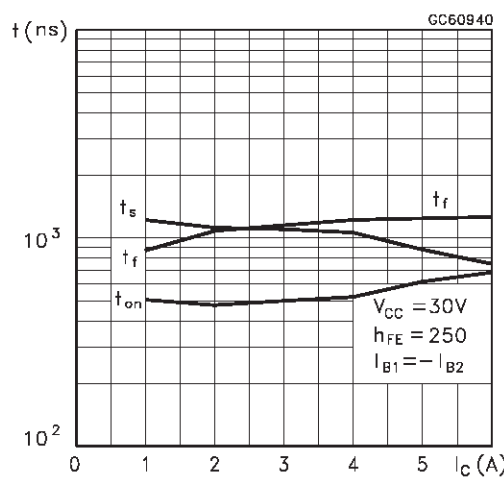

TO-252 (DPAK) MECHANICAL DATA

DIM.	mm			inch		
	MIN.	TYP.	MAX.	MIN.	TYP.	MAX.
A	2.2		2.4	0.086		0.094
A1	0.9		1.1	0.035		0.043
A2	0.03		0.23	0.001		0.009
B	0.64		0.9	0.025		0.035
B2	5.2		5.4	0.204		0.212
C	0.45		0.6	0.017		0.023
C2	0.48		0.6	0.019		0.023
D	6		6.2	0.236		0.244
E	6.4		6.6	0.252		0.260
G	4.4		4.6	0.173		0.181
H	9.35		10.1	0.368		0.397
L2		0.8			0.031	
L4	0.6		1	0.023		0.039

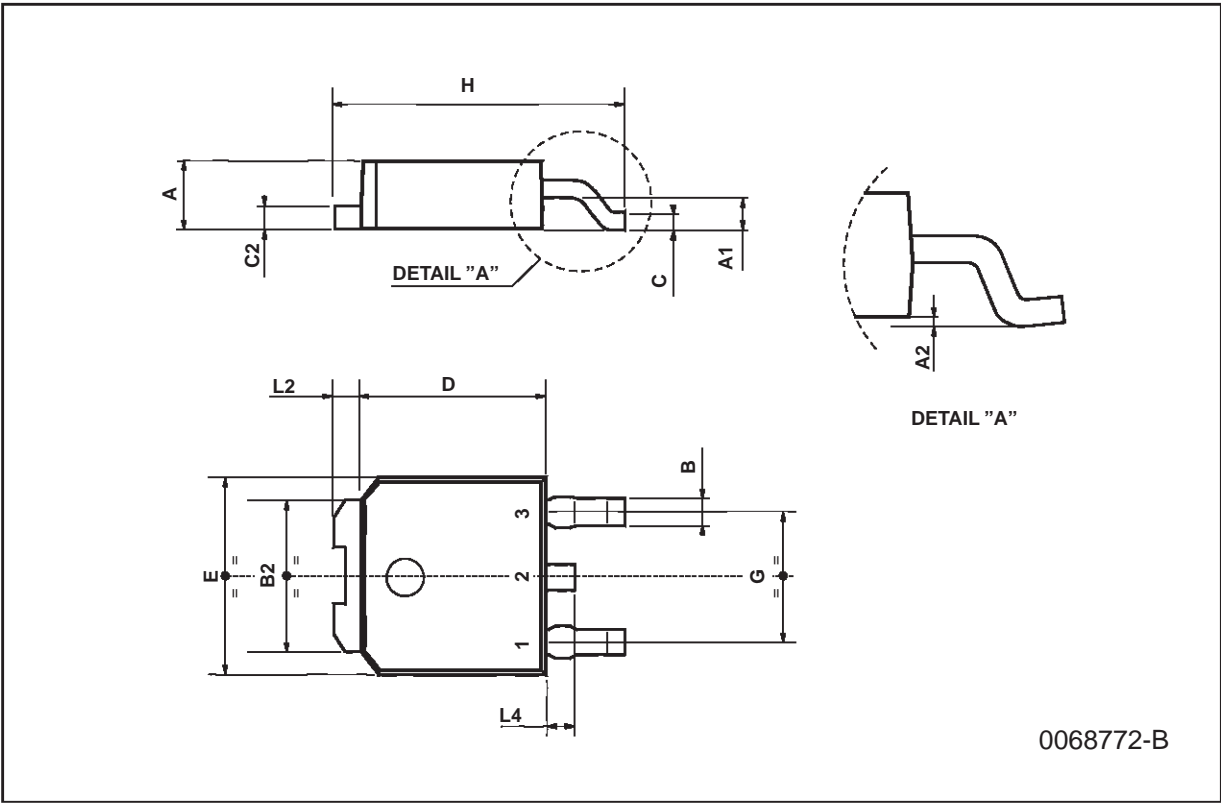

Information furnished is believed to be accurate and reliable. However, STMicroelectronics assumes no responsibility for the consequences of use of such information nor for any infringement of patents or other rights of third parties which may result from its use. No license is granted by implication or otherwise under any patent or patent rights of STMicroelectronics. Specification mentioned in this publication are subject to change without notice. This publication supersedes and replaces all information previously supplied. STMicroelectronics products are not authorized for use as critical components in life support devices or systems without express written approval of STMicroelectronics.

The ST logo is a registered trademark of STMicroelectronics

© 1998 STMicroelectronics – Printed in Italy – All Rights Reserved

STMicroelectronics GROUP OF COMPANIES

Australia - Brazil - Canada - China - France - Germany - Italy - Japan - Korea - Malaysia - Malta - Mexico - Morocco - The Netherlands - Singapore - Spain - Sweden - Switzerland - Taiwan - Thailand - United Kingdom - U.S.A.

<http://www.st.com>