

**RF & MICROWAVE TRANSISTORS
 MARISAT APPLICATIONS**

- FREQUENCY 1.65GHz
- POWER OUT 10.0W
- POWER GAIN 11.0dB
- VOLTAGE 28.0V
- HERMETIC STRIPLINE PACKAGE
- ALL GOLD METALLIZED SYSTEM
- POLYSILICON SITE BALLASTING
- OVERLAY DIE GEOMETRY
- HIGH RELIABILITY AND RUGGEDNESS
- COMMON BASE OPERATION

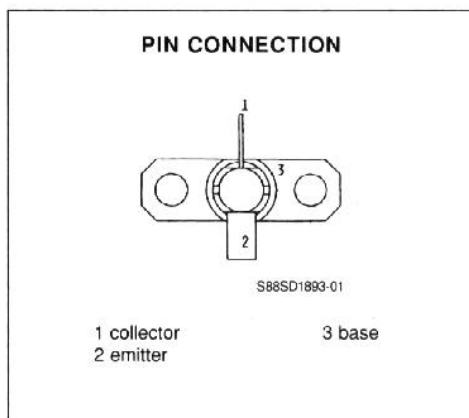

DESCRIPTION

The SD1893 is a 28V NPN Silicon Transistor designed for MARISAT Applications. This device utilizes polysilicon site ballasting with a gold metallized die to achieve high reliability and ruggedness.

ABSOLUTE MAXIMUM RATINGS ($T_{case} = 25^{\circ}C$)

Symbol	Parameter	Value	Unit
V_{CBO}	Collector - Base Voltage	45	V
V_{CEO}	Collector - Emitter Voltage	15	V
V_{EBO}	Emitter - Base Voltage	3.5	V
I_C	Collector Current (max.)	4.4	A
P_{DISS}	Total Device Dissipation at + 25°C	43	W
T_{STG}	Storage Temperature	- 65 to + 200	°C
T_J	Junction Temperature	+ 200	°C

THERMAL DATA

$R_{th(j-c)}$	Junction-case Thermal Resistance	5.5	°C/W
---------------	----------------------------------	-----	------

SD1893

ELECTRICAL CHARACTERISTICS ($T_{case} = 25^{\circ}C$)

STATIC

Symbol	Test Conditions	Value			Unit
		Min.	Typ.	Max.	
BV_{CBO}	$I_C = 4mA$	45			V
BV_{EBO}	$I_E = 4mA$	3.5			V
I_{CBO}	$V_{CB} = 28V$			5	mA
H_{FE}	$V_{CE} = 5V$ $I_C = 500mA$	15		150	

DYNAMIC

Symbol	Test Conditions	Value			Unit
		Min.	Typ.	Max.	
P_{OUT}	$f = 1.65GHz$ $V_{CC} = 28V$ $P_{in} = 0.8W$	10			W
P_{GAIN}	$f = 1.65GHz$ $V_{CC} = 28V$ $P_{in} = 0.8W$	11			dB
η_C	$f = 1.65GHz$ $V_{CC} = 28V$ $P_o = 0.8W$	40			%
C_{db}	$V_{CB} = 28V$ $f = 1MHz$ $I_E = 0$			19	PF

IMPEDANCE DATA (typical values)

TYPICAL SERIES EQUIVALENT INPUT/OUTPUT IMPEDANCE

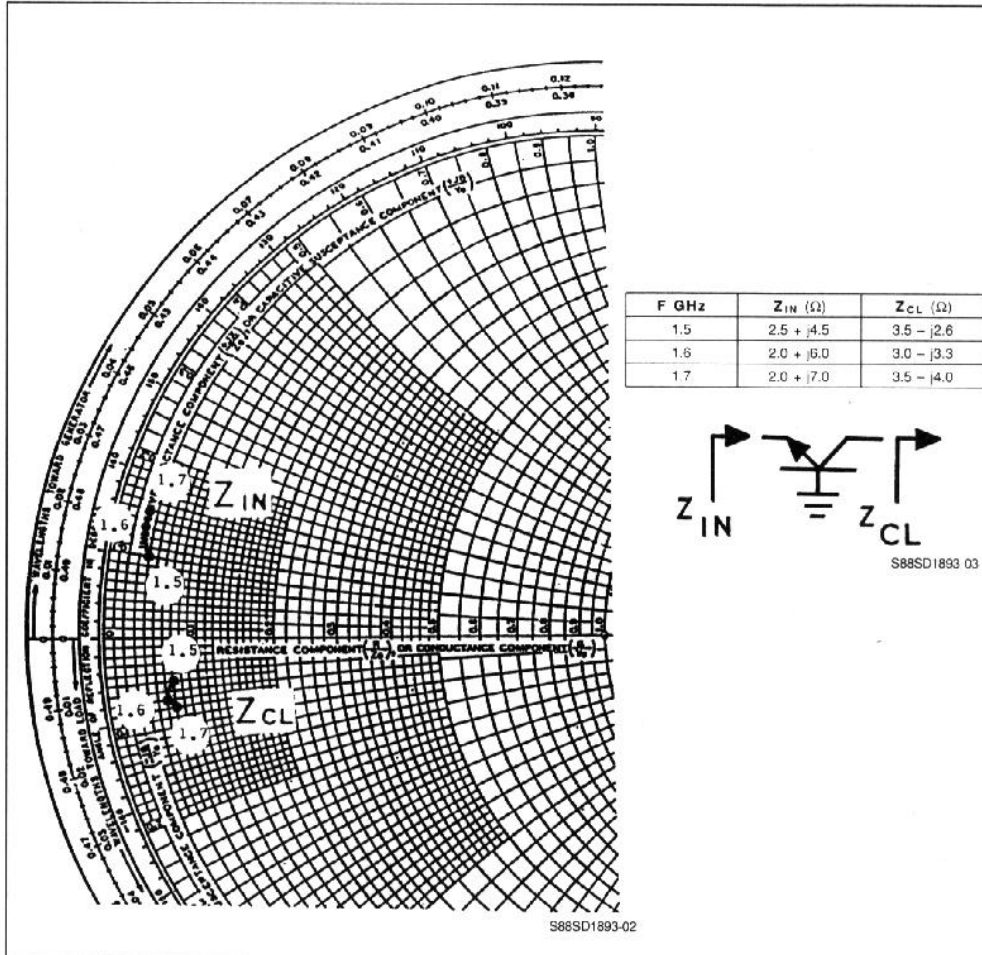

TEST CIRCUIT

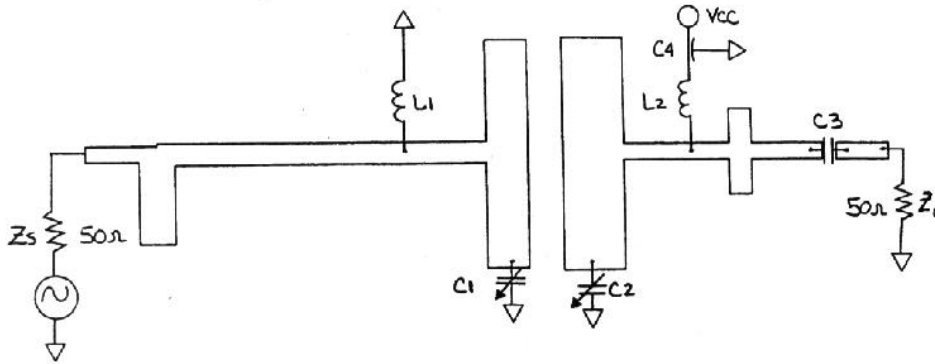

S88SD1893-04

- L1, L2 4 Turn Choke #26 AWG .080" I.D.
- C1, C2 4 2.5 of Johanson Capacitor #27283
- C3 100pF Chip Capacitor ATC ATC 100 A101KCA 150
- C4 15,000pF EMI Filter Murata/Erie 9900-381-6004
- S1 Epsilam 10 er = 10.2 H = .050"
1 oz cu SMA Launcher CD1 (2 pieces)
.230" Fixture Housing Heat Sink Advanced Corp. 5308-2CC

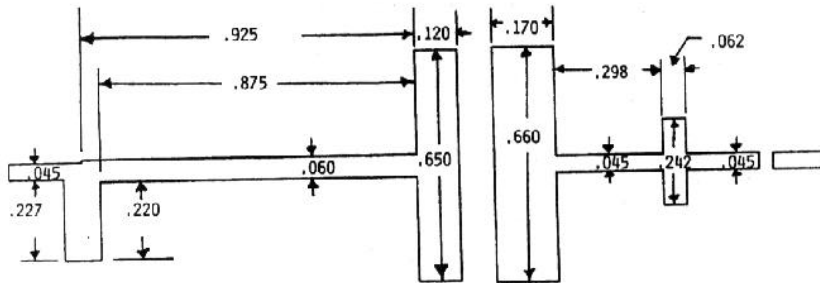

S88SD1893-05

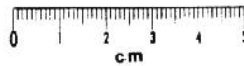
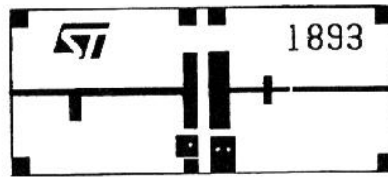

S88SD1893-06

PACKAGE MECHANICAL DATA

.230 2LFL

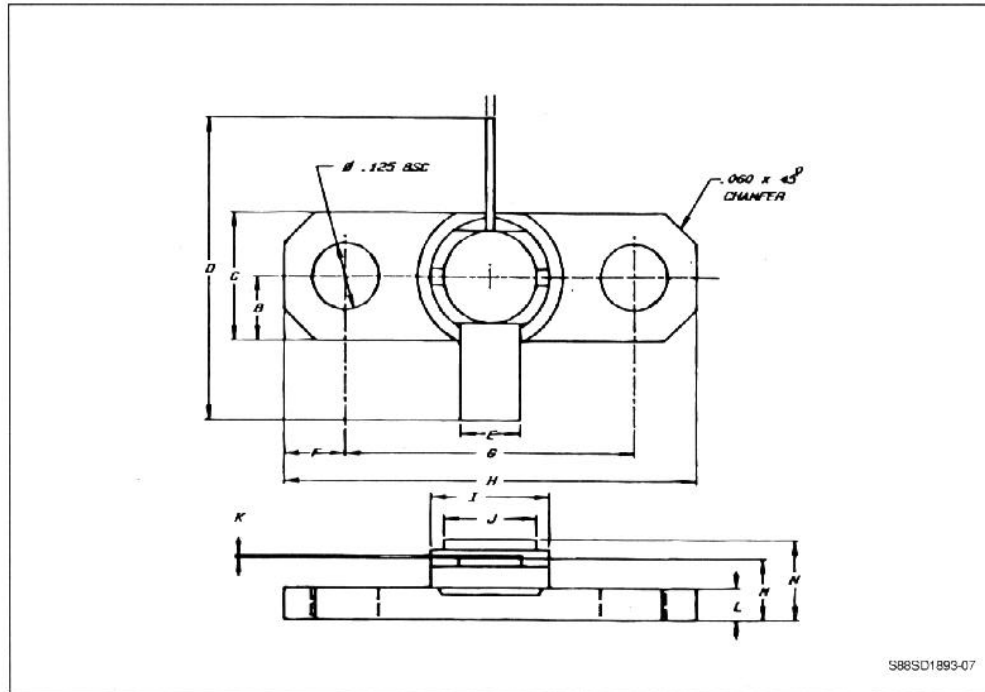

	Minimum Inches/mm	Maximum Inches/mm
A	.025/0.64	.035/0.89
B	.115/2.92 BSC	
C	.225/5.72	.235/5.97
D	.720/18.29	.750/19.05
E	.110/2.79	.120/3.05
F	.120/3.05 BSC	
G	.555/14.10	.565/14.35

	Minimum Inches/mm	Maximum Inches/mm
H	.795/20.19	.805/20.45
I	.222/5.64	.236/5.99
J	.165/4.19	.180/4.57
K	.002/0.05	.007/0.18
L	.055/1.40	.067/1.70
M	.120/3.18	.140/3.56
N	.170/4.32	