

# UTC D882SS NPN EPITAXIAL SILICON TRANSISTOR

## MEDIUM POWER LOW VOLTAGE TRANSISTOR

### FEATURES

- \*High current output up to 3A
- \*Low saturation voltage
- \*Complement to B772SS

### APPLICATIONS

- \* Audio power amplifier
- \* DC-DC convertor
- \* Voltage regulator

### MARKING

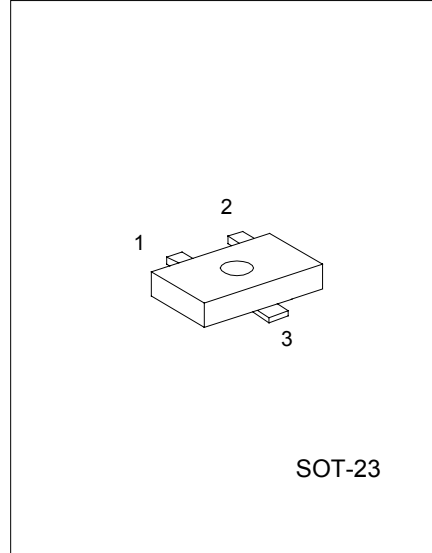
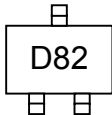

1: EMITTER 2: BASE 3: COLLECTOR

### ABSOLUTE MAXIMUM RATINGS ( Ta=25°C ,unless otherwise specified )

PARAMETERS	SYMBOL	RATING	UNIT
Collector-base voltage	V <sub>CB0</sub>	40	V
Collector-emitter voltage	V <sub>CEO</sub>	30	V
Emitter-base voltage	V <sub>EB0</sub>	5	V
Collector dissipation( T <sub>c</sub> =25°C)	P <sub>c</sub>	10	W
Collector dissipation( T <sub>a</sub> =25°C)	P <sub>c</sub>	1	W
Collector current(DC)	I <sub>c</sub>	3	A
Collector current(PULSE)	I <sub>c</sub>	7	A
Base current	I <sub>B</sub>	0.6	A
Junction Temperature	T <sub>J</sub>	150	°C
Storage Temperature	T <sub>STG</sub>	-55 ~ +150	°C

### ELECTRICAL CHARACTERISTICS(Ta=25°C,unless otherwise specified)

PARAMETER	SYMBOL	TEST CONDITIONS	MIN	TYP	MAX	UNIT
Collector cut-off current	I <sub>CB0</sub>	V <sub>CB</sub> =30V, I <sub>E</sub> =0			1000	nA
Emitter cut-off current	I <sub>EB0</sub>	V <sub>EB</sub> =3V, I <sub>c</sub> =0			1000	nA
DC current gain(note 1)	h <sub>FE1</sub>	V <sub>CE</sub> =2V, I <sub>c</sub> =20mA	30	200		
	h <sub>FE2</sub>	V <sub>CE</sub> =2V, I <sub>c</sub> =1A	100	150	400	
Collector-emitter saturation voltage	V <sub>CE(sat)</sub>	I <sub>c</sub> =2A, I <sub>B</sub> =0.2A		0.3	0.5	V
Base-emitter saturation voltage	V <sub>BE(sat)</sub>	I <sub>c</sub> =2A, I <sub>B</sub> =0.2A		1.0	2.0	V
Current gain bandwidth product	f <sub>T</sub>	V <sub>CE</sub> =5V, I <sub>c</sub> =0.1A		80		MHz
Output capacitance	C <sub>ob</sub>	V <sub>CB</sub> =10V, I <sub>E</sub> =0, f=1MHz		45		pF

**UTC** UNISONIC TECHNOLOGIES CO. LTD

1

QW-R206-018,A

# UTC D882SS NPN EPITAXIAL SILICON TRANSISTOR

Note 1: Pulse test: PW<300 $\mu$ s, Duty Cycle<2%

## CLASSIFICATION OF hFE2

RANK	Q	P	E
RANGE	100-200	160-320	200-400

## TYPICAL PARAMETERS PERFORMANCE

Fig.1 Static characteristics

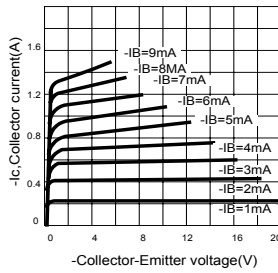

Fig.2 Derating curve of safe operating areas

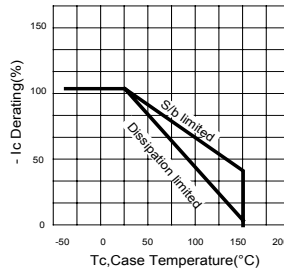

Fig.3 Power Derating

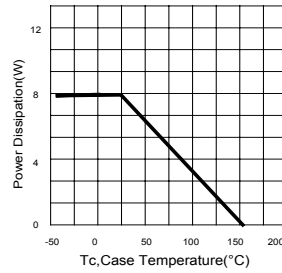

Fig.4 Collector Output capacitance

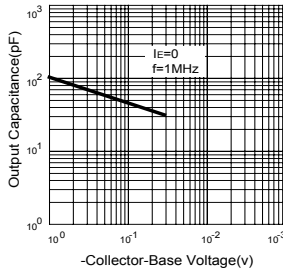

Fig.5 Current gain-bandwidth product

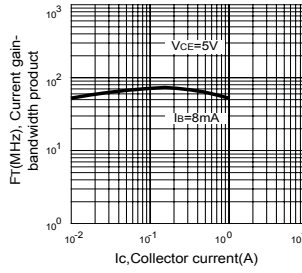

Fig.6 Safe operating area

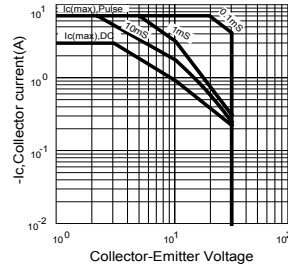

Fig.7 DC current gain

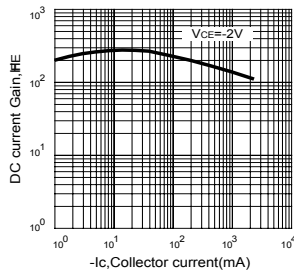
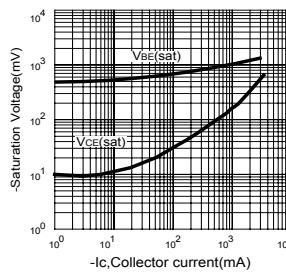

Fig.8 Saturation Voltage



UTC D882SS NPN EPITAXIAL SILICON TRANSISTOR

## UTC D882SS      NPN EPITAXIAL SILICON TRANSISTOR

---

UTC assumes no responsibility for equipment failures that result from using products at values that exceed, even momentarily, rated values (such as maximum ratings, operating condition ranges, or other parameters) listed in products specifications of any and all UTC products described or contained herein. UTC products are not designed for use in life support appliances, devices or systems where malfunction of these products can be reasonably expected to result in personal injury. Reproduction in whole or in part is prohibited without the prior written consent of the copyright owner. The information presented in this document does not form part of any quotation or contract, is believed to be accurate and reliable and may be changed without notice.