

5-V Low-Drop Fixed Voltage Regulator

TLE 4269

Version 2.0

Features

- Output voltage tolerance $\leq \pm 2\%$
- Very low current consumption
- Early warning
- Reset output low down to $V_Q = 1\text{ V}$
- Overtemperature protection
- Reverse polarity proof
- Settable reset threshold
- Very low drop voltage
- Wide temperature range
- Integrated pull up resistor at logic outputs

Type	Ordering Code	Package
TLE 4269 A	Q67000-A9190	P-DIP-8-4
TLE 4269 G	Q67006-A9173	P-DSO-8-3 (SMD)
▼ TLE 4269 GM	Q67006-A9288	P-DSO-14-8 (SMD)
TLE 4269 GL	Q67006-A9192	P-DSO-20-6 (SMD)

▼ New type

Functional Description

This device is a voltage regulator with a fixed 5-V output, e.g. in a P-DSO-8-1 package. The maximum operating voltage is 45 V. The output is able to drive a 150 mA load. It is short circuit protected and the thermal shutdown switches the output off if the junction temperature is in excess of 150 °C. A reset signal is generated for an output voltage of $V_Q < 4.6\text{ V}$. The reset threshold voltage can be decreased by external connection of a voltage divider. The reset delay time can be set by an external capacitor. Reset and sense output have integrated pull up resistors. If the integrated resistors are not desired **TLE 4279** can be used. It is also possible to supervise the input voltage by using an integrated comparator to give a low voltage warning.

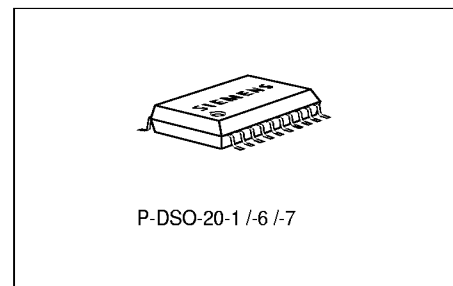
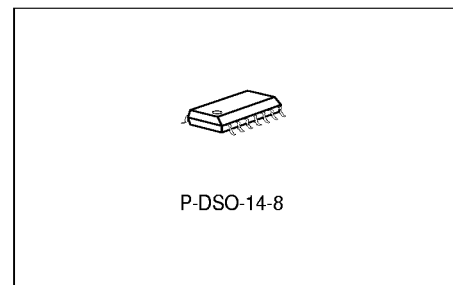
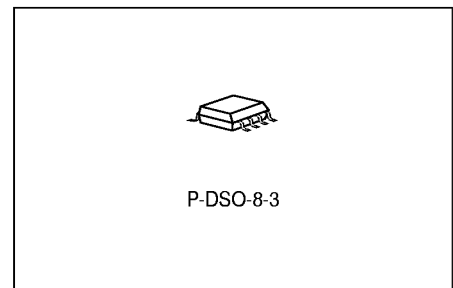
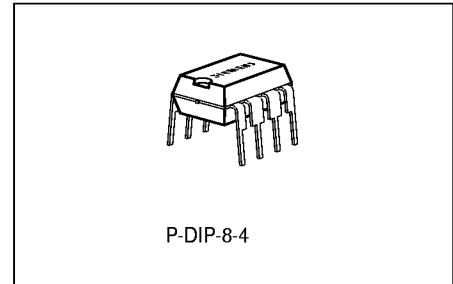

Pin Configuration
(top view)

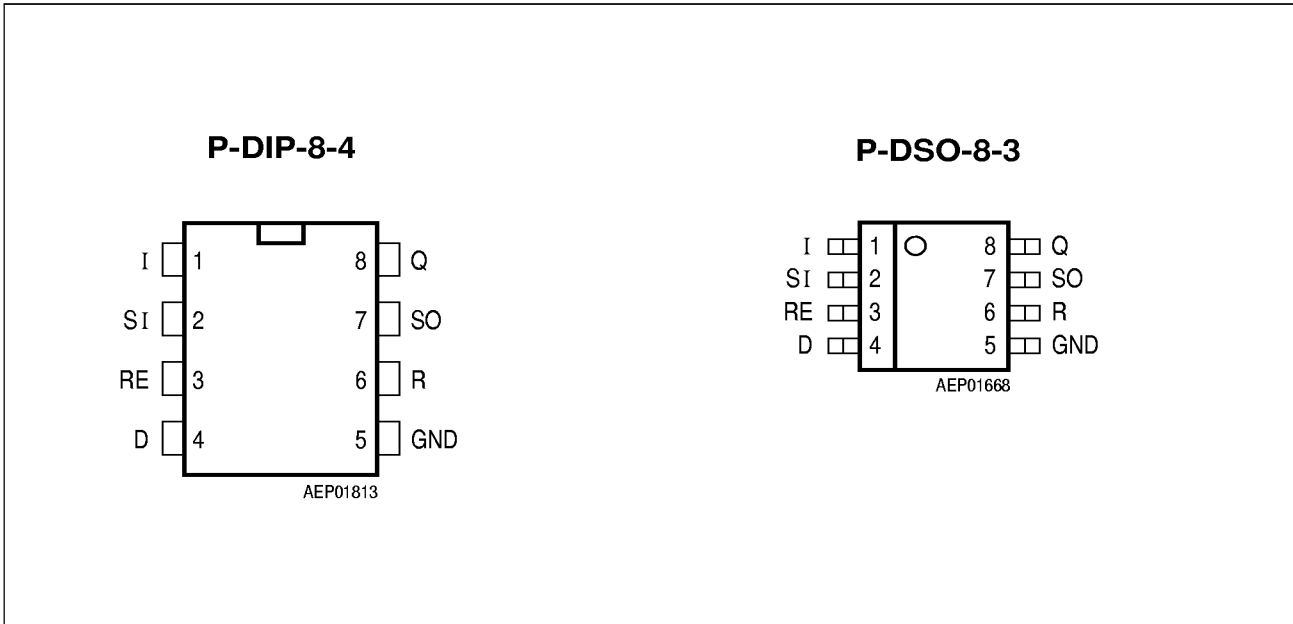

Pin Definitions and Functions (TLE 4269 A and TLE 4269 G)

Pin No.	Symbol	Function
1	I	Input ; block directly to GND on the IC with a ceramic capacitor.
2	SI	Sense Input ; if not needed connect to Q.
3	RE	Reset Threshold ; if not needed connect to ground.
4	D	Reset Delay ; to select delay time, connect to GND via external capacitor.
5	GND	Ground
6	R	Reset Output ; the open-collector output is internally linked to Q via a 20 kΩ pull-up resistor. Keep open, if not needed.
7	SO	Sense Output ; the open-collector output is internally linked to the output via a 20 kΩ pull-up resistor. Keep open, if not needed.
8	Q	5-V Output ; connect to GND with a 10 μF capacitor, ESR < 10 Ω.

Pin Configuration
(top view)

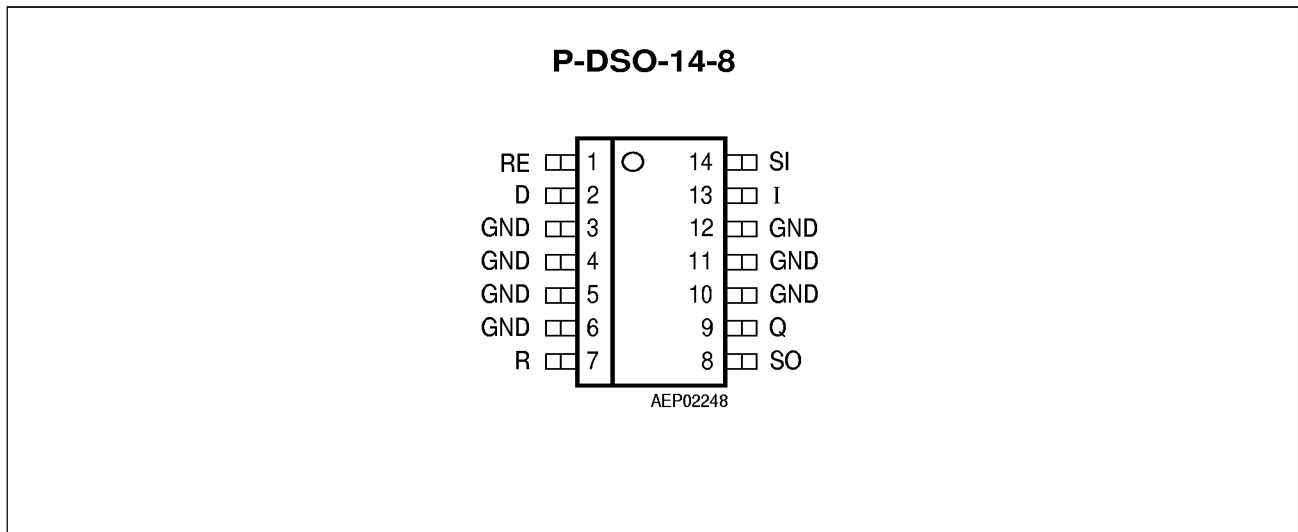

Pin Definitions and Functions (TLE 4269 GM)

Pin No.	Symbol	Function
1	RE	Reset Threshold; if not needed connect to GND.
2	D	Reset Delay; connect to GND via external delay capacitor for setting delay time.
3, 4, 5, 6	GND	Ground
7	R	Reset Output; open-collector output, internally connected to Q via a pull-up resistor of 20 kΩ. Keep open, if not needed.
8	SO	Sense Output; open-collector output, internally connected to Q via a 20 kΩ pull-up resistor. Keep open, if not needed.
9	Q	5-V Output; connect to GND with a 10 μF capacitor, ESR < 10 Ω.
10, 11, 12	GND	Ground
13	I	Input; block to GND directly at the IC by a ceramic capacitor.
14	SI	Sense Input; if not needed connect to Q.

Pin Configuration
(top view)

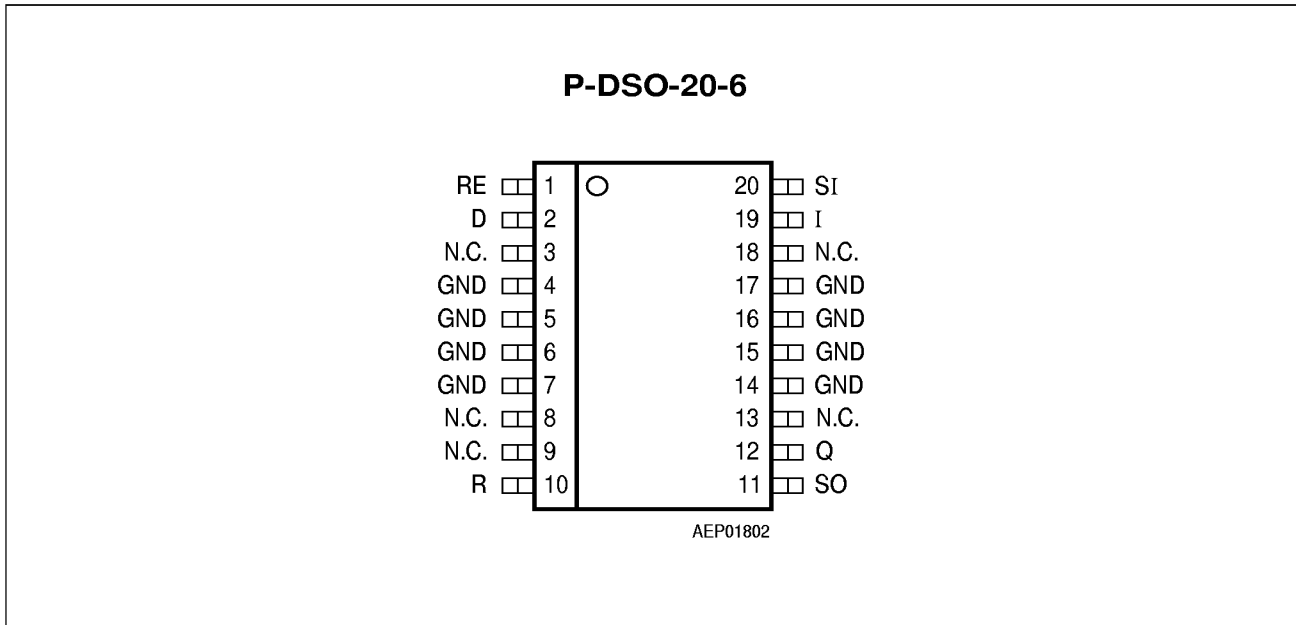

Pin Definitions and Functions (TLE 4269 GL)

Pin No.	Symbol	Function
1	RE	Reset Threshold; if not needed connect to GND.
2	D	Reset Delay; to select delay time connect to GND via external capacitor.
4-7, 14-17	GND	Ground
10	R	Reset Output; the open-collector output is internally linked to Q via 20 kΩ pull-up resistor. Keep open, if not needed.
11	SO	Sense Output; the open-collector output is internally linked to Q via 20 kΩ pull-up resistor. Keep open, if not needed.
12	Q	Output; connect to GND with a 10 μF capacitor, ESR < 10 Ω.
19	I	Input; block directly to GND at the IC by a ceramic capacitor.
20	SI	Sense Input; if not needed connect to Q.

Circuit Description

The control amplifier compares a reference voltage, made highly accurate by resistance balancing, with a voltage proportional to the output voltage and drives the base of the series PNP transistor via a buffer. Saturation control as a function of the load current prevents any over-saturation of the power element.

In the reset generator block a comparator compares a reference voltage independent of the input voltage with the scaled-down output voltage. If the output voltage reaches 4.6 V the reset delay capacitor is discharged and the reset output is set to low. This low is guaranteed down to an output voltage of 1 V. As the output voltage increases again, from 4.6 V onward the reset delay capacitor is charged with constant current. When the capacitor voltage reaches the upper switching threshold V_{dT} , the reset returns to high. By choosing the value of this capacitor, the reset delay time can be selected over a wide range. With the reset threshold input RE it is possible to lower the reset threshold V_{rt} . If pin RE is connected to pin Q via a voltage divider, for example, the reset condition is reached when this voltage is decreased below the switching threshold V_{re} of 1.35 V.

Another comparator compares the signal of the pin SI, normally fed by a voltage divider from the input voltage, with the reference and gives an early warning on the pin SO. It is also possible to supervise an other voltage e.g. of a second regulator, or to build a watchdog circuit with few external components.

Application Description

The input capacitor C_i is necessary for compensating line influences. Using a resistor of approx. 1 Ω in series with C_i , the oscillating circuit consisting of input inductivity and input capacitance can be damped. The output capacitor C_o is necessary for the stability of the regulating circuit. Stability is guaranteed at values $\geq 10 \mu\text{F}$ and an ESR $\leq 10 \Omega$ within the operating temperature range. For small tolerances of the reset delay the spread of the capacitance of the delay capacitor and its temperature coefficient should be noted.

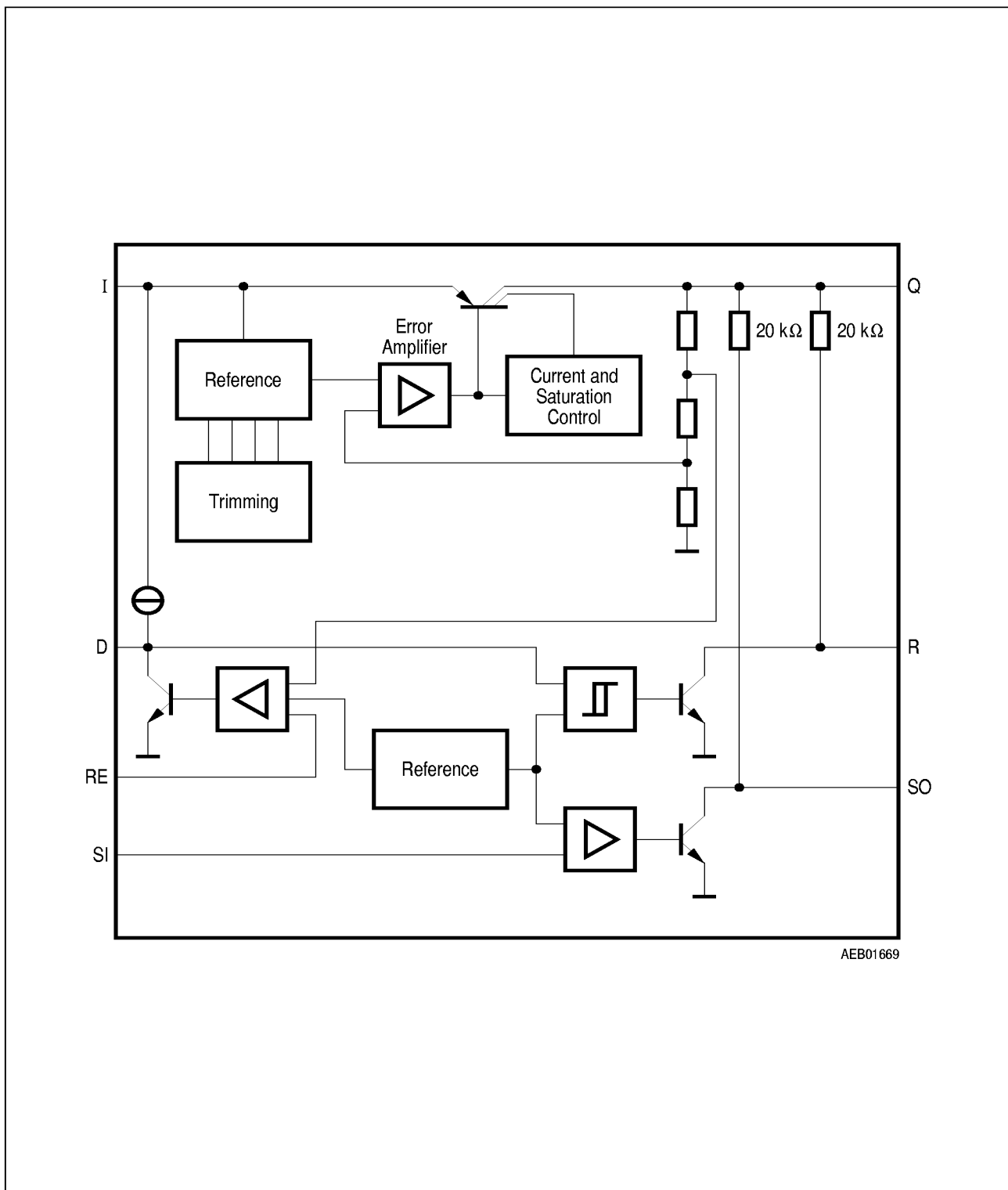

Block Diagram

Absolute Maximum Ratings

$T_j = -40$ to 150 °C

Parameter	Symbol	Limit Values		Unit	Notes
		min.	max.		

Input

Input voltage	V_I	- 40	45	V	-
Input current	I_I	-	-	-	internal limited

Sense Input

Input voltage	V_{SI}	- 40	45	V	-
Input current	I_{SI}	1	1	mA	-

Reset Threshold

Voltage	V_{RE}	- 0.3	7	V	-
Current	I_{RE}	- 10	10	mA	-

Reset Delay

Voltage	V_D	- 0.3	7	V	-
Current	I_D	-	-	-	internal limited

Ground

Current	I_{GND}	50	-	mA	-
---------	-----------	----	---	----	---

Reset Output

Voltage	V_R	- 0.3	7	V	-
Current	I_R	-	-	-	internal limited

Absolute Maximum Ratings (cont'd)

$T_j = -40$ to 150 °C

Parameter	Symbol	Limit Values		Unit	Notes
		min.	max.		

Sense Output

Voltage	V_{SO}	- 0.3	7	V	-
Current	I_{SO}	-	-	-	internal limited

5-V Output

Output voltage	V_Q	- 0.3	7	V	-
Output current	I_Q	- 5	-	mA	-

Temperature

Junction temperature	T_j	-	150	°C	-
Storage temperature	T_{Stg}	- 50	150	°C	-

Operating Range

Input voltage	V_I	-	45	V	-
Junction temperature	T_j	- 40	150	°C	-

Thermal Data

Junction-ambient	R_{thja}	-	100	K/W	P-DIP-8-4
			200	K/W	P-DSO-8-3
			70	K/W	P-DSO-14-8
			70	K/W	P-DSO-20-6
Junction-case	R_{thjc}	-	60	K/W	P-DIP-8-4
			60	K/W	P-DSO-8-3
Junction-pin	R_{thjc}	-	30	K/W	P-DSO-14-8 ¹⁾
			30	K/W	P-DSO-20-6 ¹⁾

¹⁾ measured to Pin 4

Characteristics

$V_I = 13.5 \text{ V}; T_j = -40 \text{ }^\circ\text{C} < T_j < 125 \text{ }^\circ\text{C}$

Parameter	Symbol	Limit Values			Unit	Measuring Condition
		min.	typ.	max.		
Output voltage	V_Q	4.90	5.00	5.10	V	$1 \text{ mA} \leq I_Q \leq 100 \text{ mA}$ $6 \text{ V} \leq V_I \leq 16 \text{ V}$
Current limit	I_Q	150	200	500	mA	–
Current consumption; $I_q = I_I - I_Q$	I_q	–	150	300	μA	$I_Q \leq 1 \text{ mA}, T_j < 85 \text{ }^\circ\text{C}$
Current consumption; $I_q = I_I - I_Q$	I_q	–	250	700	μA	$I_Q = 10 \text{ mA}$
Current consumption; $I_q = I_I - I_Q$	I_q	–	2	8	mA	$I_Q = 50 \text{ mA}$
Drop voltage	V_{dr}	–	0.25	0.5	V	$I_Q = 100 \text{ mA}^1)$
Load regulation	ΔV_Q	–	10	30	mV	$I_Q = 5 \text{ mA to } 100 \text{ mA}$
Line regulation	ΔV_Q	–	10	40	mV	$V_I = 6 \text{ V to } 26 \text{ V}$ $I_Q = 1 \text{ mA}$

Reset Generator

Switching threshold	V_{rt}	4.50	4.65	4.80	V	–
Reset pull up	–	10	20	40	$\text{k}\Omega$	–
Reset low voltage	V_R	–	0.1	0.4	V	R_{intern}
Delay switching threshold	V_{dt}	1.4	1.8	2.2	V	–
Switching threshold	V_{st}	0.3	0.45	0.60	V	–
Reset delay low voltage	V_D	–		0.1	V	$V_Q < V_{RT}$
Charge current	I_d	3.0	6.5	9.5	μA	$V_D = 1 \text{ V}$

¹⁾ Drop voltage = $V_I - V_Q$ (measured when the output voltage has dropped 100 mV from the nominal value obtained at 13.5 V input.)

Characteristics (cont'd)

$V_1 = 13.5 \text{ V}; T_j = -40 \text{ }^\circ\text{C} < T_j < 125 \text{ }^\circ\text{C}$

Parameter	Symbol	Limit Values			Unit	Measuring Condition
		min.	typ.	max.		
Delay time L → H	t_d	17	28	–	ms	$C_D = 100 \text{ nF}$
Delay time H → L	t_t	–	1	–	μs	$C_D = 100 \text{ nF}$
Switching voltage	V_{re}	1.26	1.35	1.44	V	$V_Q > 3.5 \text{ V}$

Input Voltage Sense

Sense threshold high	$V_{si, high}$	1.24	1.31	1.38	V	–
Sense threshold low	$V_{si, low}$	1.16	1.20	1.28	V	–
Sense output low voltage	$V_{SO, low}$	–	0.1	0.4	V	$V_{SI} < 1.20 \text{ V};$ $V_Q > 3 \text{ V}$ R_{intern}
Sense pull up	–	10	20	40	$\text{k}\Omega$	–
Sense input current	I_{SI}	– 1	0.1	1	μA	–

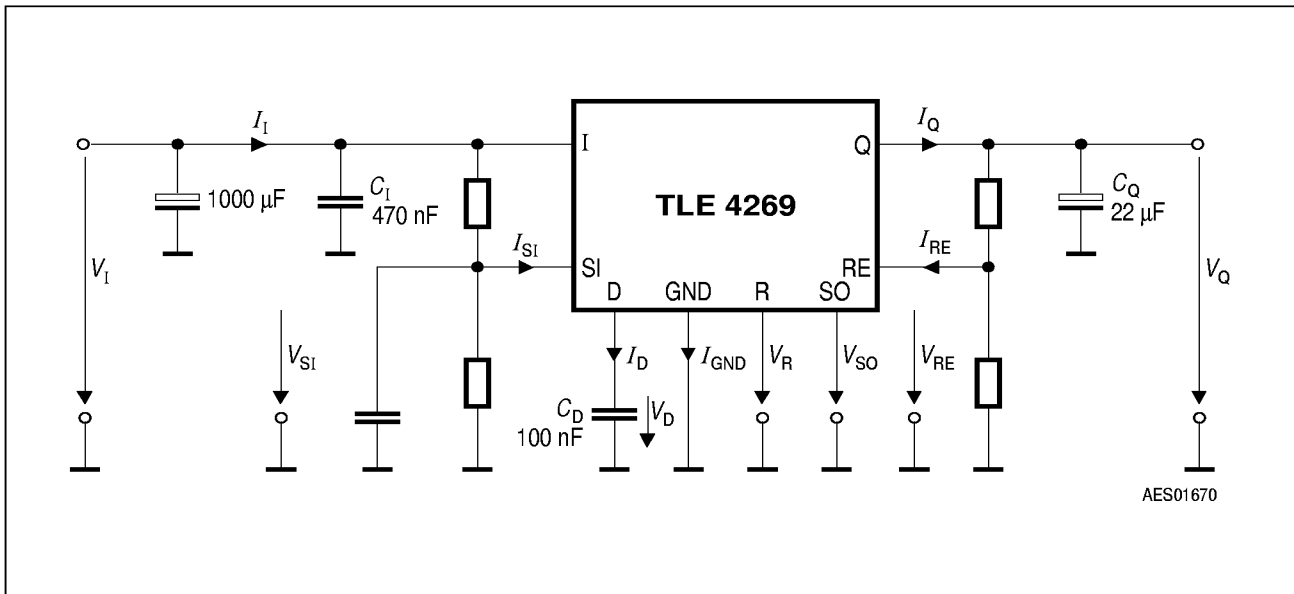

Measuring Circuit

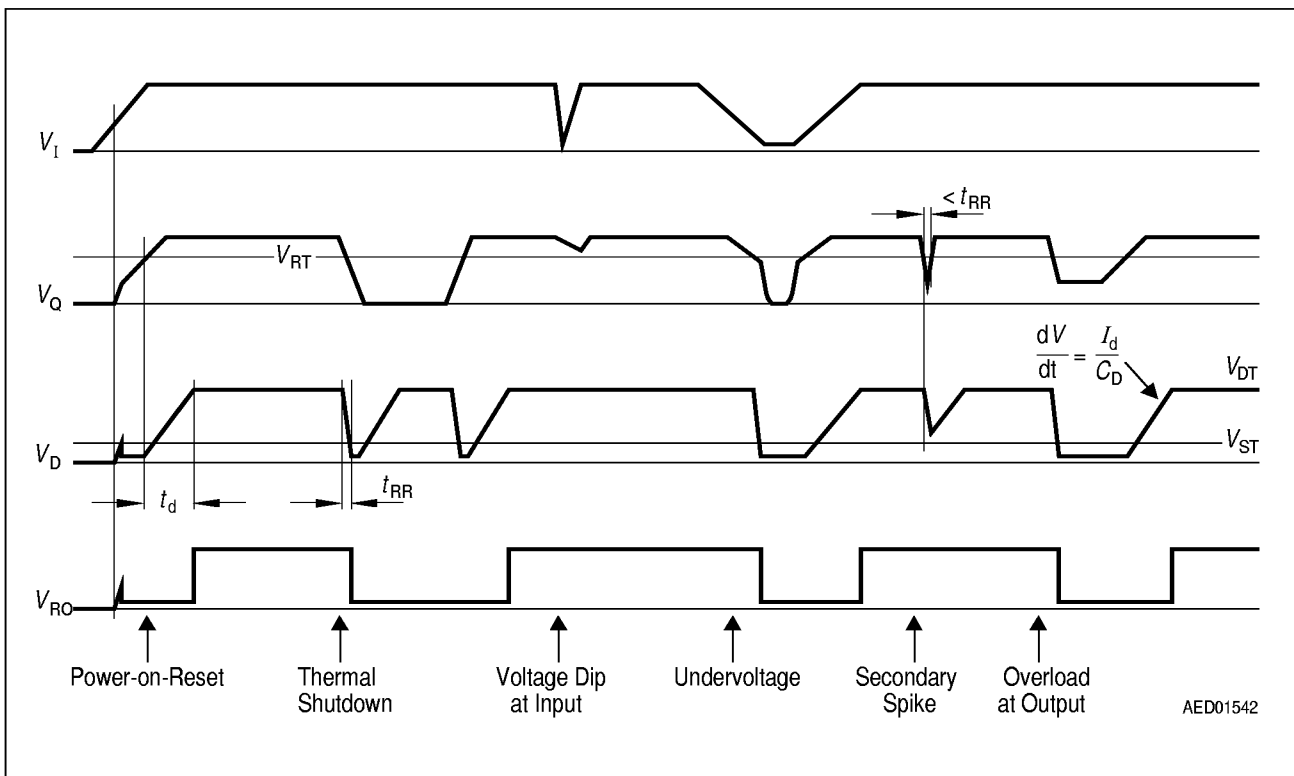

Reset Timing Diagram

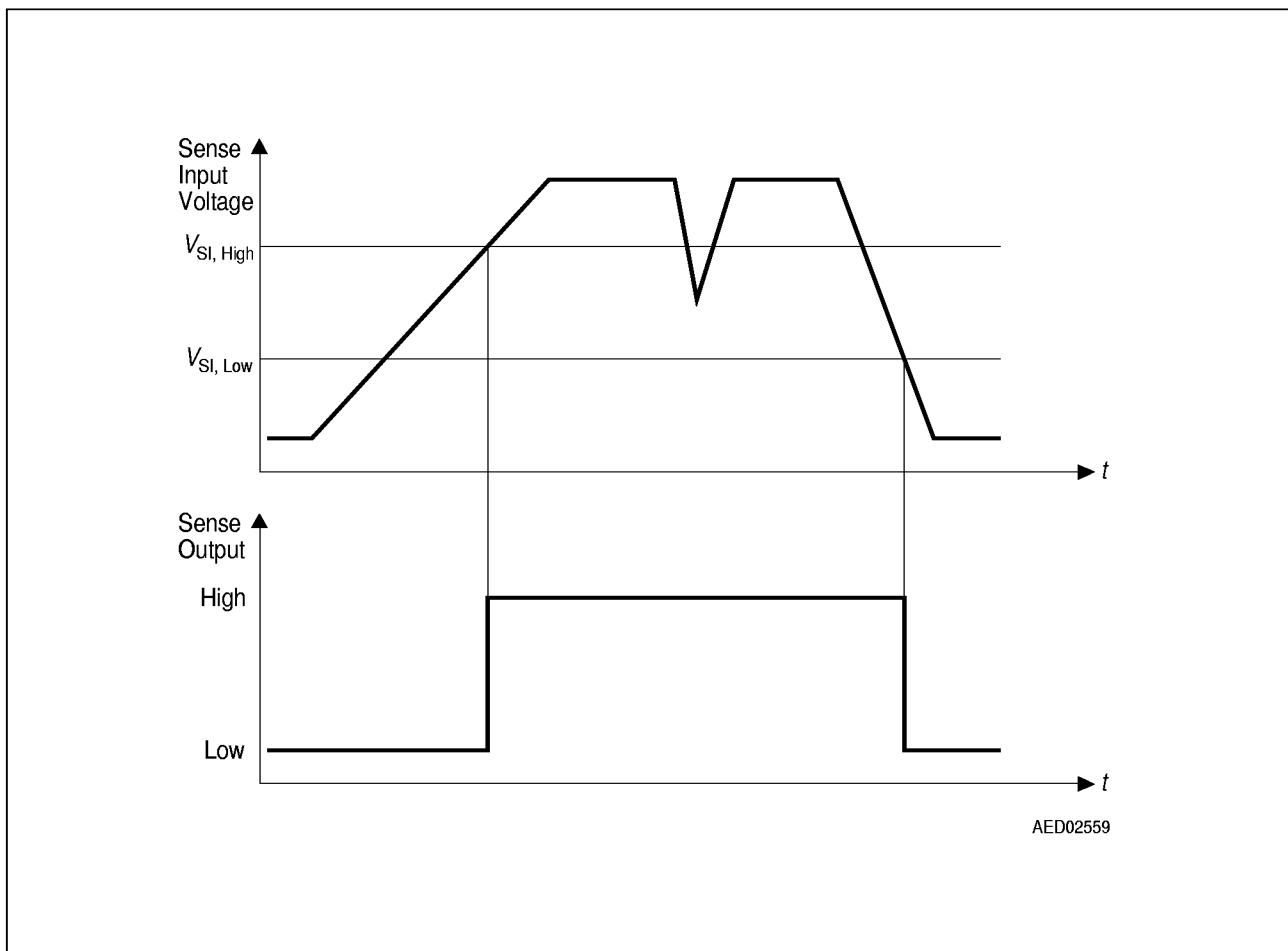

Sence Timing Diagram

Charge Current I_d versus Temperature T_j

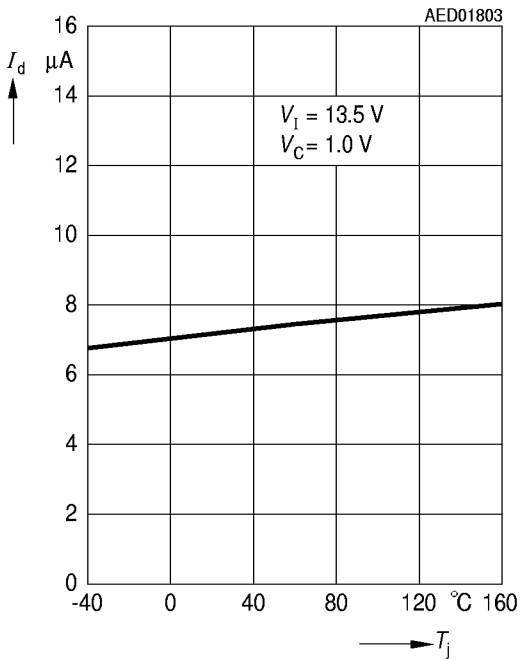

Switching Voltage V_{dt} and V_{st} versus Temperature T_j

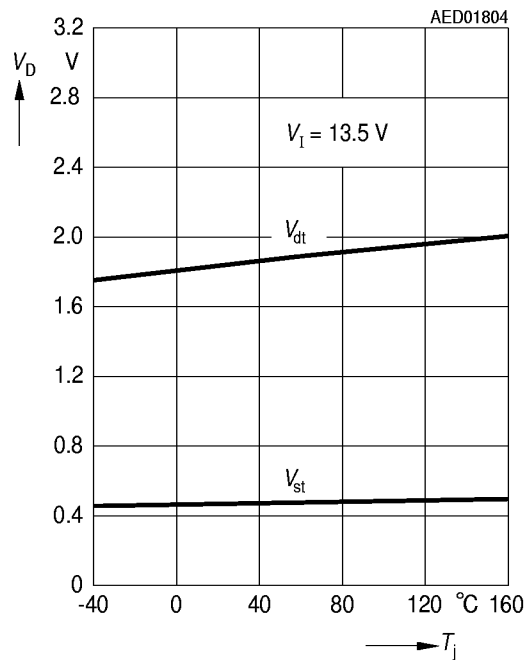

Drop Voltage V_{dr} versus Output Current I_O

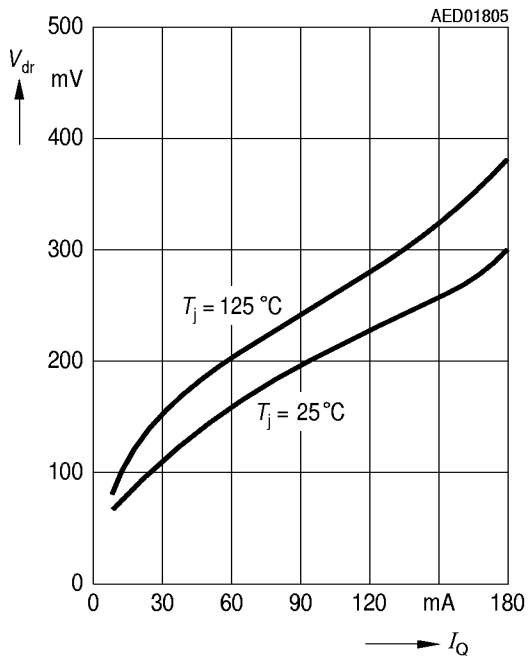

Reset Switching Threshold V_{re} versus Temperature T_j

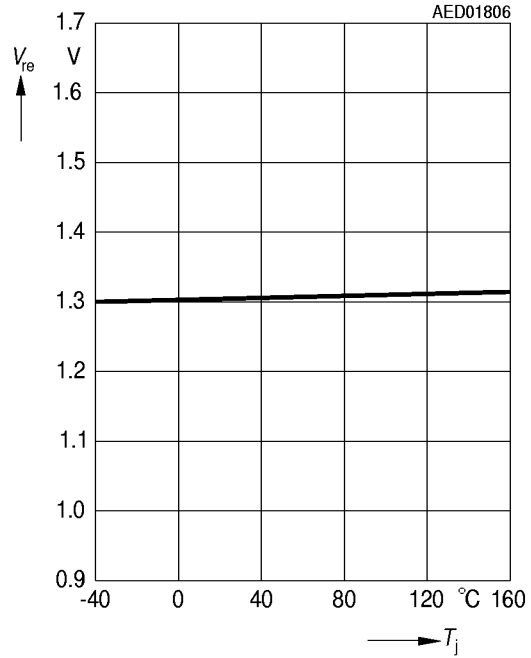

Current Consumption I_Q versus Input Voltage V_I

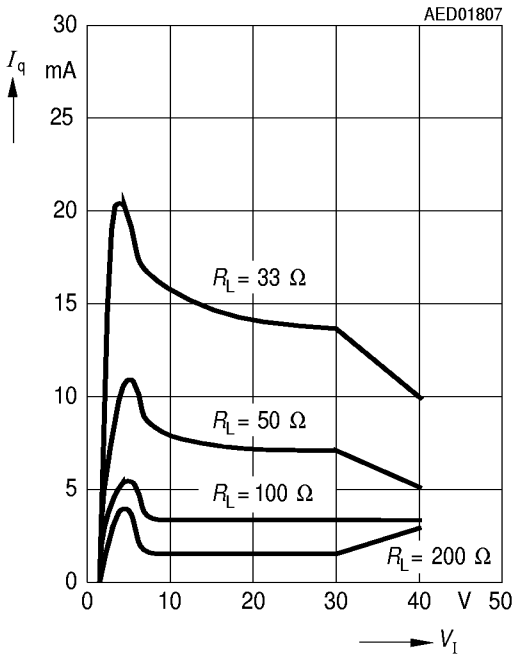

Output Voltage V_O versus Input Voltage V_I

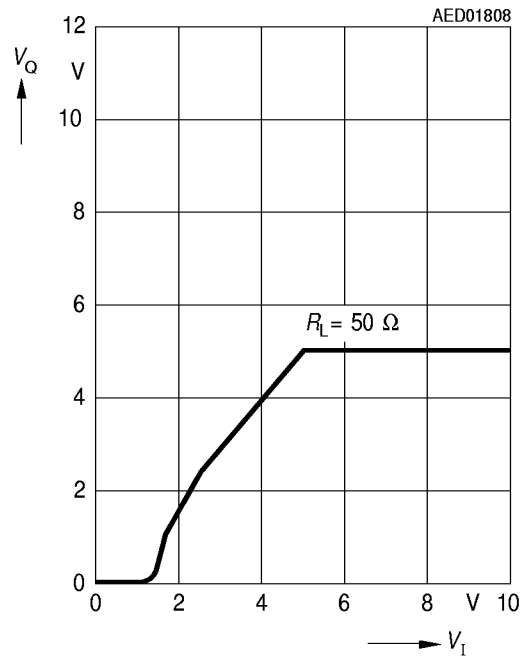

Sense Threshold V_{si} versus Temperature T_j

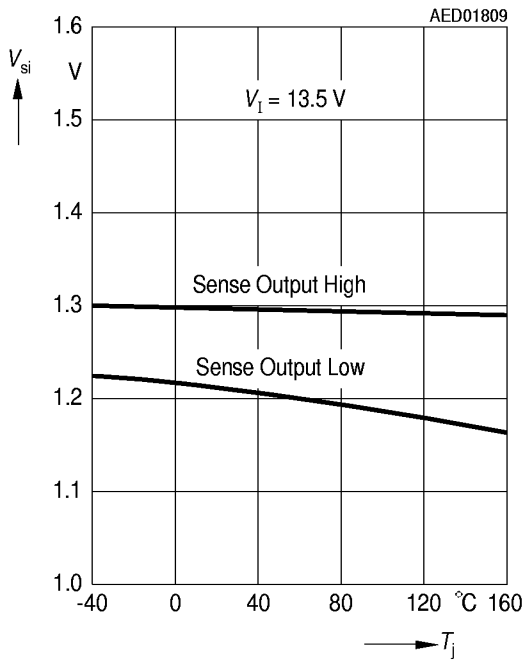

Output Voltage V_O versus Temperature T_j

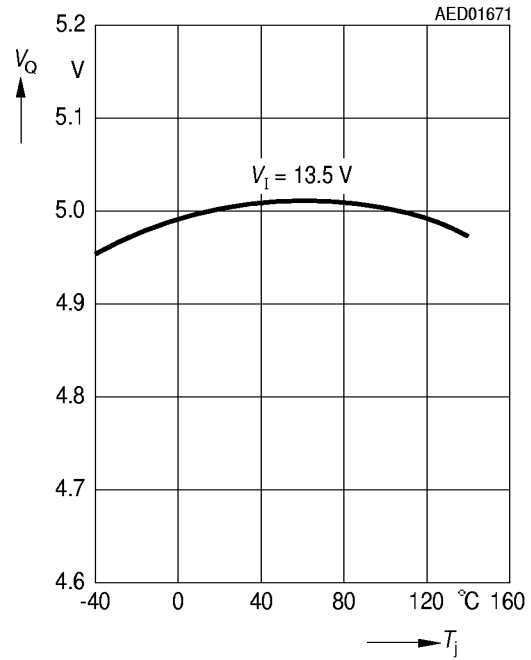

Output Current I_Q versus Input Voltage V_I

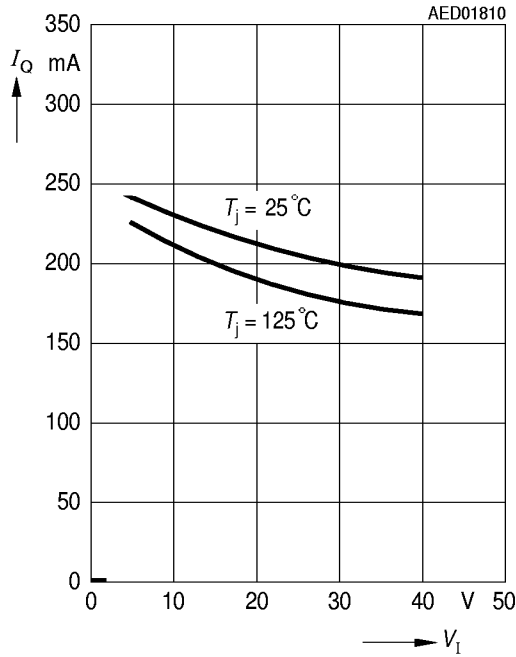

Current Consumption I_q versus Output Current I_Q

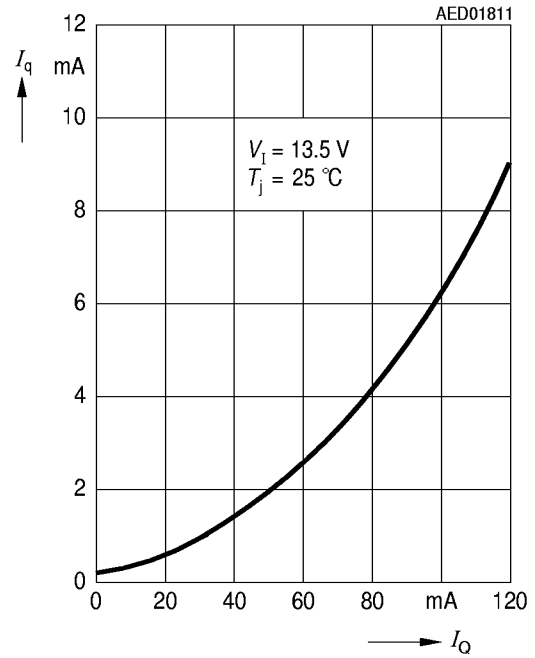

Current Consumption I_q versus Output Current I_Q

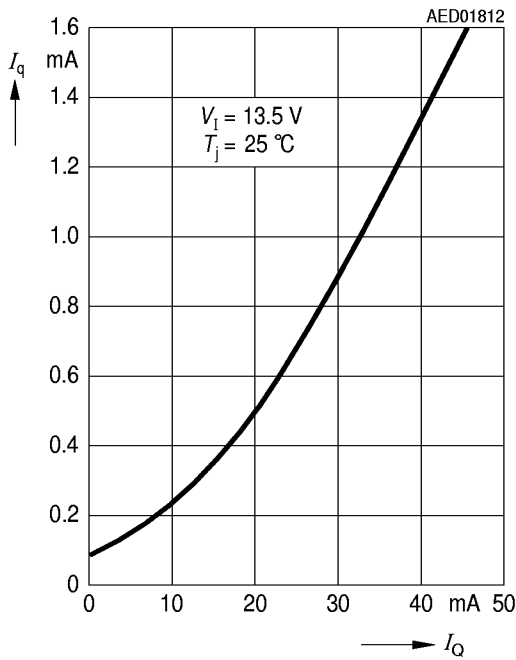

Package Outlines

P-DIP-8-4
(Plastic Dual In-line)

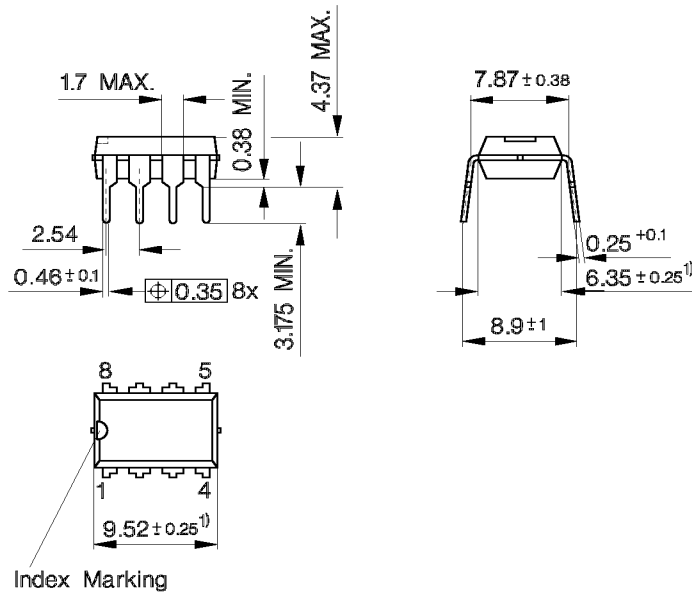

Index Marking

1) Does not include plastic or metal protrusion of 0.25 max. per side

GPD05583

Sorts of Packing

Package outlines for tubes, trays etc. are contained in our Data Book "Package Information"

Dimensions in mm

P-DSO-14-8 (SMD)
(Plastic Dual Small Outline)

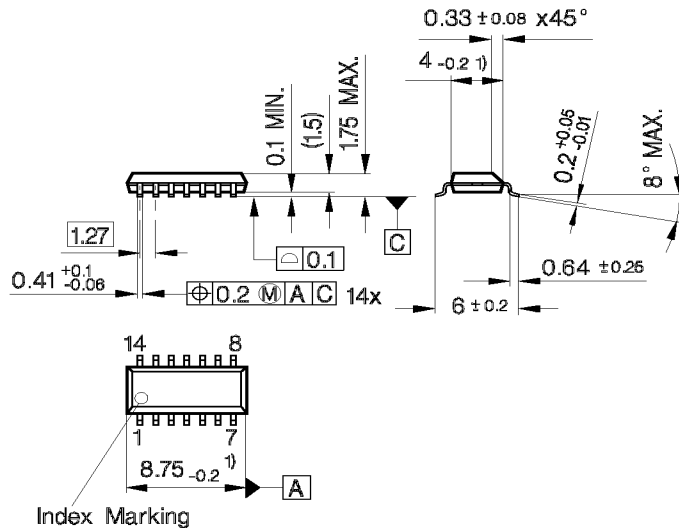

1) Does not include plastic or metal protrusion of 0.15 max. per side

GPS09222

Sorts of Packing

Package outlines for tubes, trays etc. are contained in our Data Book "Package Information"

Dimensions in mm

SMD = Surface Mounted Device

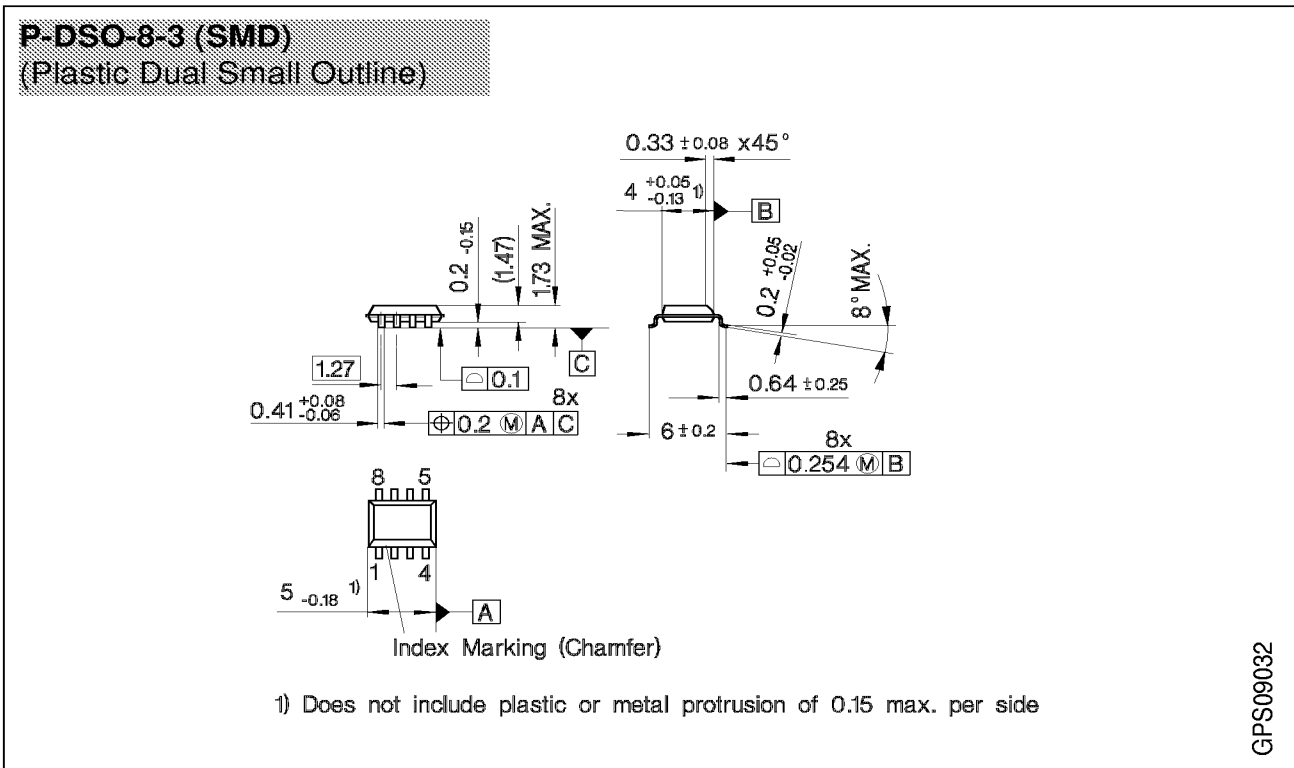

Sorts of Packing

Package outlines for tubes, trays etc. are contained in our Data Book "Package Information"

SMD = Surface Mounted Device

Dimensions in mm

P-DSO-20-6 (SMD)
 (Plastic Dual Small Outline)

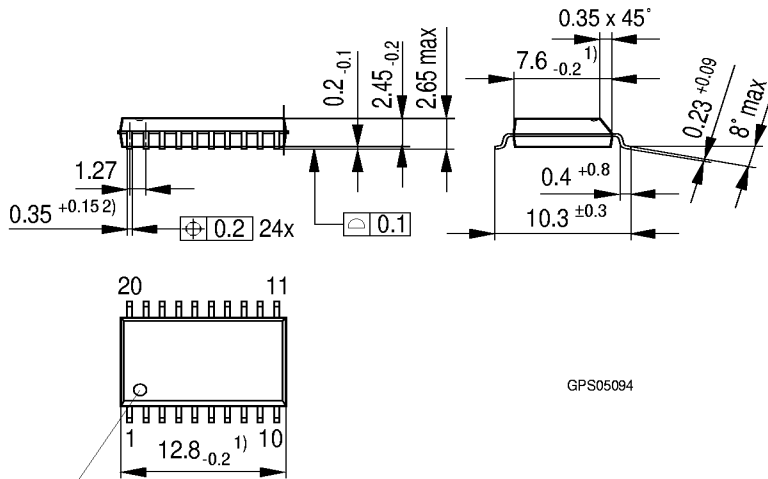

GPS05094

Index Marking

- 1) Does not include plastic or metal protrusions of 0.15 max per side
- 2) Does not include dambar protrusion of 0.05 max per side

Sorts of Packing

Package outlines for tubes, trays etc. are contained in our Data Book "Package Information"

Dimensions in mm

SMD = Surface Mounted Device