

# IRGIB6B60KD

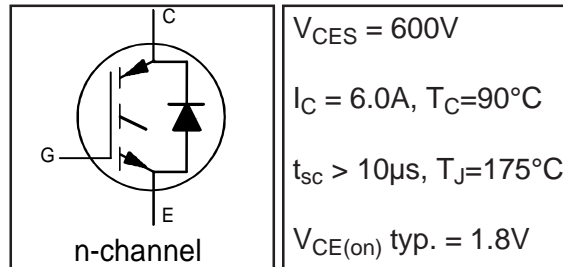
## INSULATED GATE BIPOLAR TRANSISTOR WITH ULTRAFAST SOFT RECOVERY DIODE

### Features

- Low VCE (on) Non Punch Through IGBT Technology.
- Low Diode VF.
- 10µs Short Circuit Capability.
- Square RBSOA.
- Ultrasoft Diode Reverse Recovery Characteristics.
- Positive VCE (on) Temperature Coefficient.

### Benefits

- Benchmark Efficiency for Motor Control.
- Rugged Transient Performance.
- Low EMI.
- Excellent Current Sharing in Parallel Operation.



### Absolute Maximum Ratings

	Parameter	Max.	Units
$V_{CES}$	Collector-to-Emitter Voltage	600	V
$I_C @ T_C = 25^\circ\text{C}$	Continuous Collector Current	11	A
$I_C @ T_C = 100^\circ\text{C}$	Continuous Collector Current	7.0	
$I_{CM}$	Pulse Collector Current (Ref.Fig.C.T.5)	22	
$I_{LM}$	Clamped Inductive Load current ①	22	
$I_F @ T_C = 25^\circ\text{C}$	Diode Continuous Forward Current	9.0	
$I_F @ T_C = 100^\circ\text{C}$	Diode Continuous Forward Current	6.0	
$I_{FM}$	Diode Maximum Forward Current	18	
$V_{ISOL}$	RMS Isolation Voltage, Terminal to Case, $t = 1 \text{ min}$	2500	V
$V_{GE}$	Gate-to-Emitter Voltage	$\pm 20$	
$P_D @ T_C = 25^\circ\text{C}$	Maximum Power Dissipation	38	W
$P_D @ T_C = 100^\circ\text{C}$	Maximum Power Dissipation	19	
$T_J$	Operating Junction and	-55 to +175	°C
$T_{STG}$	Storage Temperature Range		
	Soldering Temperature for 10 sec.	300 (0.063 in. (1.6mm) from case)	
	Mounting Torque, 6-32 or M3 Screw	10 lbf.in (1.1N.m)	

### Thermal / Mechanical Characteristics

	Parameter	Min.	Typ.	Max.	Units
$R_{\theta JC}$	Junction-to-Case- IGBT	—	—	3.9	°C/W
$R_{\theta JC}$	Junction-to-Case- Diode	—	—	6.0	
$R_{\theta CS}$	Case-to-Sink, flat, greased surface	—	0.50	—	
$R_{\theta JA}$	Junction-to-Ambient, typical socket mount	—	—	62	
Wt	Weight	—	2.0	—	g

# IRGIB6B60KD

International  
IR Rectifier

## Electrical Characteristics @ T<sub>J</sub> = 25°C (unless otherwise specified)

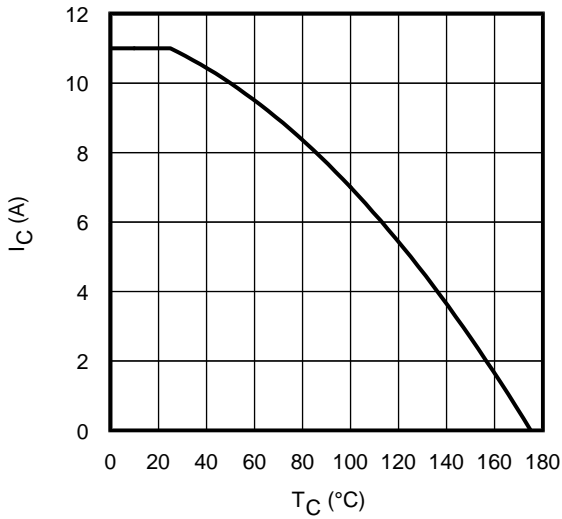
	Parameter	Min.	Typ.	Max.	Units	Conditions	Ref.Fig.
V <sub>(BR)CES</sub>	Collector-to-Emitter Breakdown Voltage	600	—	—	V	V <sub>GE</sub> = 0V, I <sub>C</sub> = 500μA	
ΔV <sub>(BR)CES</sub> /ΔT <sub>J</sub>	Temperature Coeff. of Breakdown Voltage	—	0.30	—	V/°C	V <sub>GE</sub> = 0V, I <sub>C</sub> = 1mA (25°C-150°C)	
V <sub>CE(on)</sub>	Collector-to-Emitter Voltage	1.50	1.80	2.20	V	I <sub>C</sub> = 5A, V <sub>GE</sub> = 15V, T <sub>J</sub> = 25°C	5,6,7
		—	2.20	2.50		I <sub>C</sub> = 5A, V <sub>GE</sub> = 15V, T <sub>J</sub> = 150°C	
		—	2.30	2.60		I <sub>C</sub> = 5A, V <sub>GE</sub> = 15V, T <sub>J</sub> = 175°C	9,10,11
V <sub>GE(th)</sub>	Gate Threshold Voltage	3.5	4.5	5.5	V	V <sub>CE</sub> = V <sub>GE</sub> , I <sub>C</sub> = 250μA	9,10,11
ΔV <sub>GE(th)</sub> /ΔT <sub>J</sub>	Threshold Voltage temp. coefficient	—	-10	—	mV/°C	V <sub>CE</sub> = V <sub>GE</sub> , I <sub>C</sub> = 1mA (25°C-150°C)	12
g <sub>f</sub>	Forward Transconductance	—	3.0	—	S	V <sub>CE</sub> = 50V, I <sub>C</sub> = 5.0A, PW = 80μs	
I <sub>CES</sub>	Zero Gate Voltage Collector Current	—	1.0	150	μA	V <sub>GE</sub> = 0V, V <sub>CE</sub> = 600V	
		—	200	500		V <sub>GE</sub> = 0V, V <sub>CE</sub> = 600V, T <sub>J</sub> = 150°C	
		—	720	1100		V <sub>GE</sub> = 0V, V <sub>CE</sub> = 600V, T <sub>J</sub> = 175°C	
V <sub>FM</sub>	Diode Forward Voltage Drop	—	1.25	1.45	V	I <sub>F</sub> = 5.0A, V <sub>GE</sub> = 0V	8
		—	1.20	1.40		I <sub>F</sub> = 5.0A, V <sub>GE</sub> = 0V, T <sub>J</sub> = 150°C	
		—	1.15	1.35		I <sub>F</sub> = 5.0A, V <sub>GE</sub> = 0V, T <sub>J</sub> = 175°C	
I <sub>GES</sub>	Gate-to-Emitter Leakage Current	—	—	±100	nA	V <sub>GE</sub> = ±20V, V <sub>CE</sub> = 0V	

## Switching Characteristics @ T<sub>J</sub> = 25°C (unless otherwise specified)

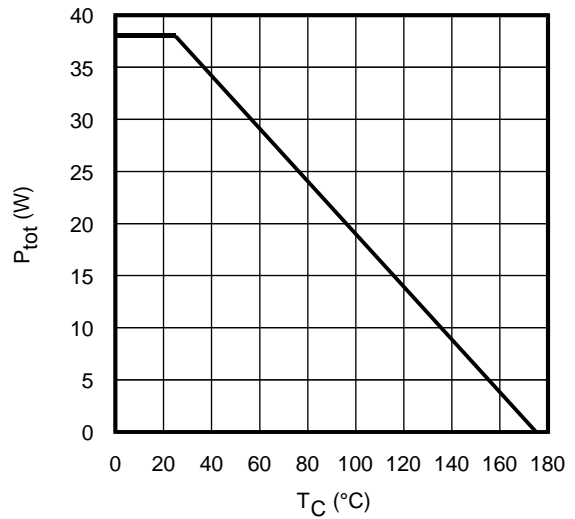
	Parameter	Min.	Typ.	Max.	Units	Conditions	Ref.Fig.		
Q <sub>g</sub>	Total Gate Charge (turn-on)	—	18.2	27.3	nC	I <sub>C</sub> = 5.0A	23		
Q <sub>ge</sub>	Gate-to-Emitter Charge (turn-on)	—	1.9	2.85		V <sub>CC</sub> = 400V	CT1		
Q <sub>gc</sub>	Gate-to-Collector Charge (turn-on)	—	9.2	13.8		V <sub>GE</sub> = 15V			
E <sub>on</sub>	Turn-On Switching Loss	—	110	210	μJ	I <sub>C</sub> = 5.0A, V <sub>CC</sub> = 400V	CT4		
E <sub>off</sub>	Turn-Off Switching Loss	—	135	245		V <sub>GE</sub> = 15V, R <sub>G</sub> = 100Ω, L = 1.4mH			
E <sub>tot</sub>	Total Switching Loss	—	245	455		L <sub>S</sub> = 150nH, T <sub>J</sub> = 25°C ②			
t <sub>d(on)</sub>	Turn-On delay time	—	25	34	ns	I <sub>C</sub> = 5.0A, V <sub>CC</sub> = 400V	CT4		
t <sub>r</sub>	Rise time	—	17	26		V <sub>GE</sub> = 15V, R <sub>G</sub> = 100Ω, L = 1.4mH			
t <sub>d(off)</sub>	Turn-Off delay time	—	215	230		L <sub>S</sub> = 150nH, T <sub>J</sub> = 25°C			
t <sub>f</sub>	Fall time	—	13.2	22					
E <sub>on</sub>	Turn-On Switching Loss	—	150	260		μJ		I <sub>C</sub> = 5.0A, V <sub>CC</sub> = 400V	CT4
E <sub>off</sub>	Turn-Off Switching Loss	—	190	300				V <sub>GE</sub> = 15V, R <sub>G</sub> = 100Ω, L = 1.4mH	
E <sub>tot</sub>	Total Switching Loss	—	340	560	L <sub>S</sub> = 150nH, T <sub>J</sub> = 150°C ②				
t <sub>d(on)</sub>	Turn-On delay time	—	28	37	ns	I <sub>C</sub> = 5.0A, V <sub>CC</sub> = 400V	14,16		
t <sub>r</sub>	Rise time	—	17	26		V <sub>GE</sub> = 15V, R <sub>G</sub> = 100Ω, L = 1.4mH			
t <sub>d(off)</sub>	Turn-Off delay time	—	240	255		L <sub>S</sub> = 150nH, T <sub>J</sub> = 150°C			
t <sub>f</sub>	Fall time	—	18	27					
L <sub>E</sub>	Internal Emitter Inductance	—	7.5	—		nH		Measured 5 mm from package	
C <sub>ies</sub>	Input Capacitance	—	290	435	pF	V <sub>GE</sub> = 0V	22		
C <sub>oes</sub>	Output Capacitance	—	34	51		V <sub>CC</sub> = 30V			
C <sub>res</sub>	Reverse Transfer Capacitance	—	10	15		f = 1.0MHz			
RB <sub>SOA</sub>	Reverse Bias Safe Operating Area	FULL SQUARE				T <sub>J</sub> = 150°C, I <sub>C</sub> = 18A, V <sub>p</sub> = 600V	4		
SC <sub>SOA</sub>	Short Circuit Safe Operating Area	10	—	—	μs	V <sub>CC</sub> = 500V, V <sub>GE</sub> = +15V to 0V, R <sub>G</sub> = 100Ω	CT2		
						T <sub>J</sub> = 150°C, V <sub>p</sub> = 600V, R <sub>G</sub> = 100Ω	CT3		
I <sub>SC (PEAK)</sub>	Peak Short Circuit Collector Current	—	50	—	A	V <sub>CC</sub> = 360V, V <sub>GE</sub> = +15V to 0V	WF4		
E <sub>rec</sub>	Reverse Recovery Energy of the Diode	—	90	175	μJ	T <sub>J</sub> = 150°C	17,18,19		
t <sub>rr</sub>	Diode Reverse Recovery Time	—	70	91	ns	V <sub>CC</sub> = 400V, I <sub>F</sub> = 5.0A, L = 1.4mH	20,21		
I <sub>rr</sub>	Peak Reverse Recovery Current	—	10	13	A	V <sub>GE</sub> = 15V, R <sub>G</sub> = 100Ω, L <sub>S</sub> = 150nH	CT4,WF3		
Q <sub>rr</sub>	Diode Reverse Recovery Charge	—	350	455	nC	di/dt = 400A/μs			

① V<sub>CC</sub> = 80% (V<sub>CES</sub>), V<sub>GE</sub> = 20V, L = 100μH, R<sub>G</sub> = 50Ω.

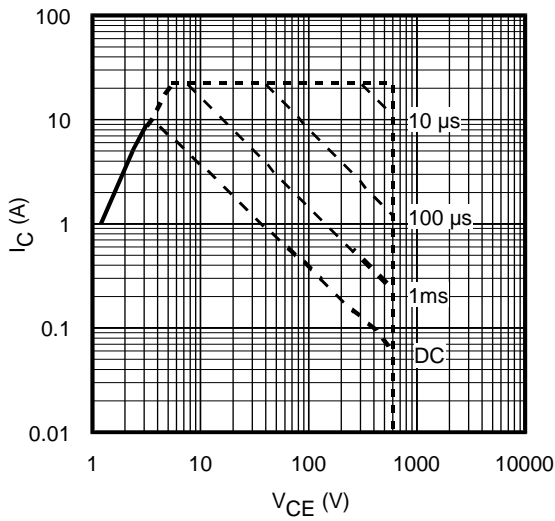
② Energy losses include "tail" and diode reverse recovery.



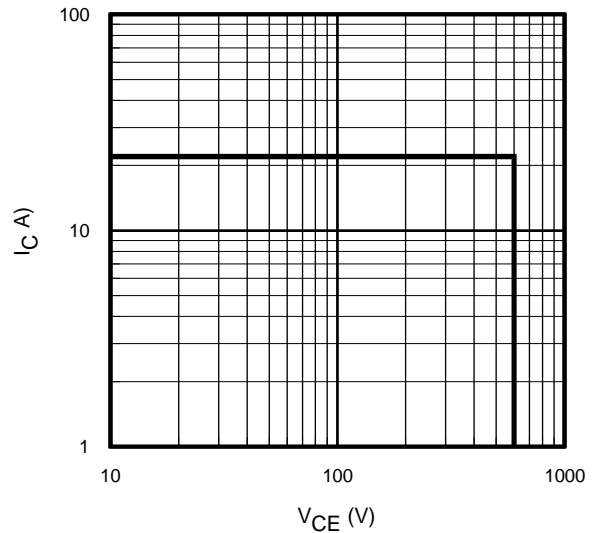
**Fig. 1** - Maximum DC Collector Current vs. Case Temperature



**Fig. 2** - Power Dissipation vs. Case Temperature

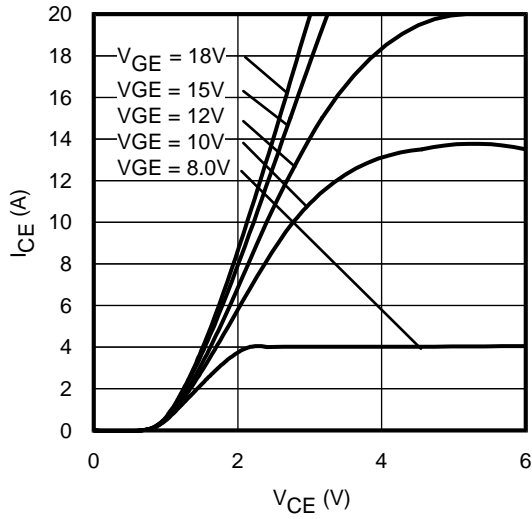


**Fig. 3** - Forward SOA  
 $T_C = 25^\circ\text{C}$ ;  $T_J \leq 175^\circ\text{C}$

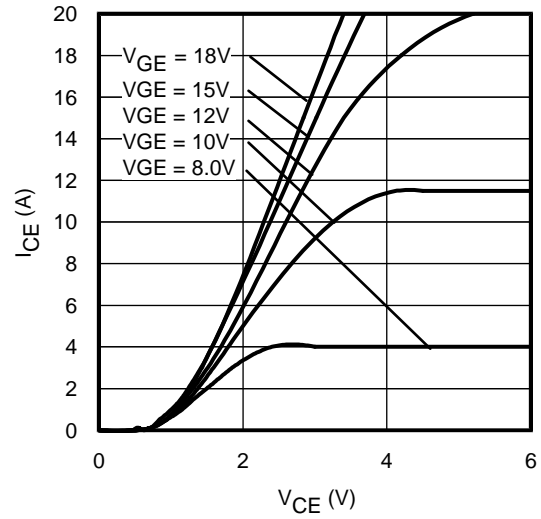


**Fig. 4** - Reverse Bias SOA  
 $T_J = 175^\circ\text{C}$ ;  $V_{GE} = 15\text{V}$

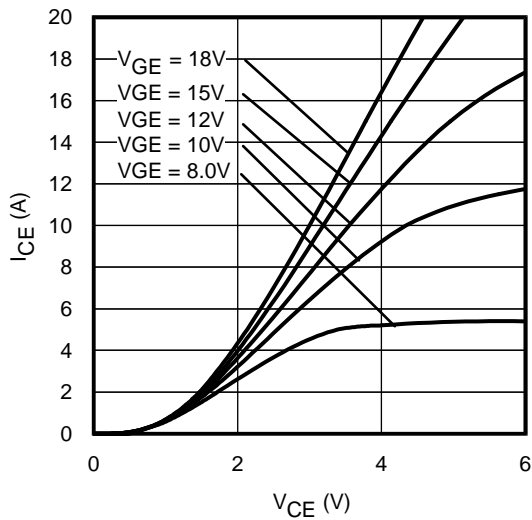
# IRGIB6B60KD



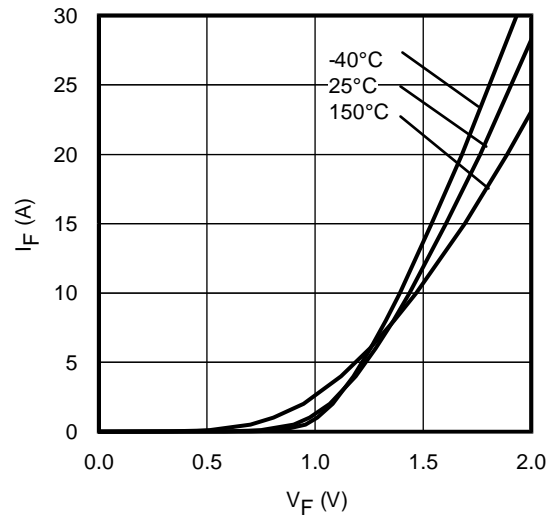
**Fig. 5** - Typ. IGBT Output Characteristics  
 $T_J = -40^\circ\text{C}$ ;  $t_p = 80\mu\text{s}$



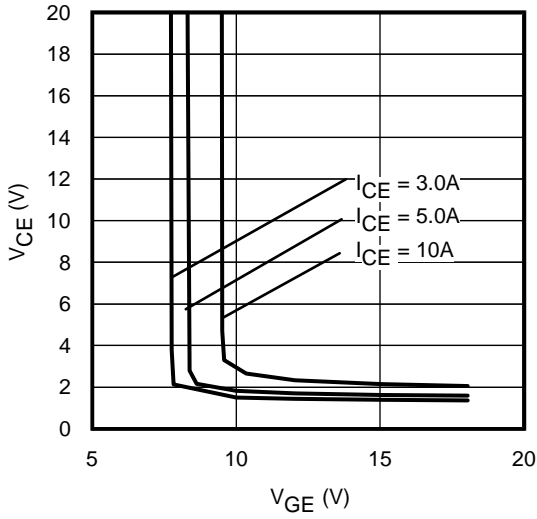
**Fig. 6** - Typ. IGBT Output Characteristics  
 $T_J = 25^\circ\text{C}$ ;  $t_p = 80\mu\text{s}$



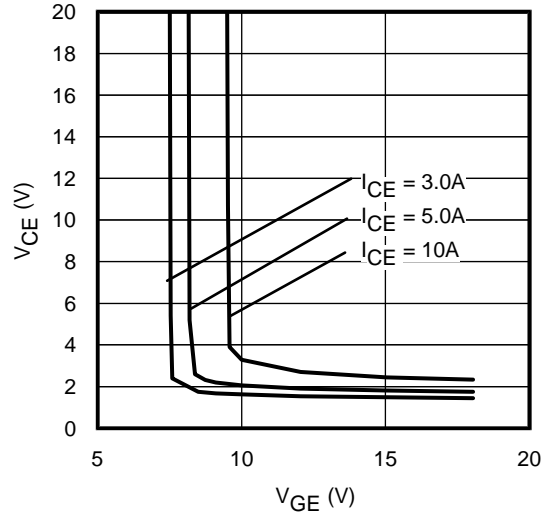
**Fig. 7** - Typ. IGBT Output Characteristics  
 $T_J = 150^\circ\text{C}$ ;  $t_p = 80\mu\text{s}$



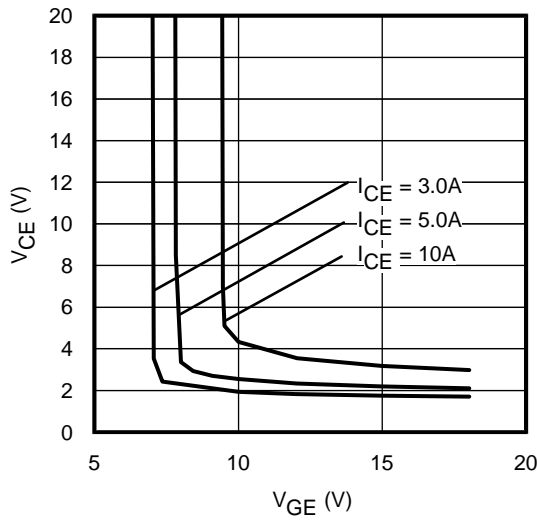
**Fig. 8** - Typ. Diode Forward Characteristics  
 $t_p = 80\mu\text{s}$



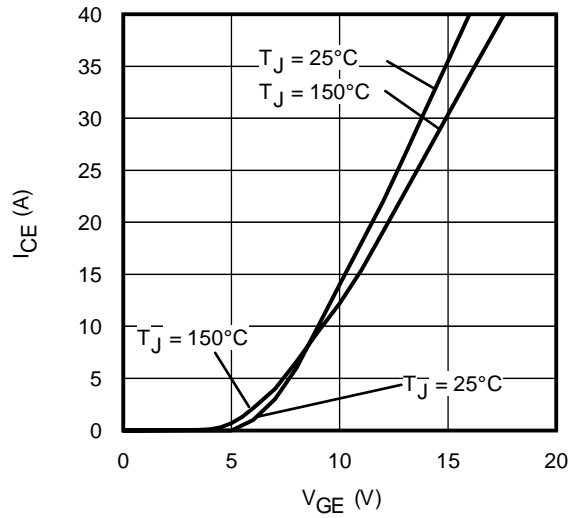
**Fig. 9** - Typical  $V_{CE}$  vs.  $V_{GE}$   
 $T_J = -40^\circ\text{C}$



**Fig. 10** - Typical  $V_{CE}$  vs.  $V_{GE}$   
 $T_J = 25^\circ\text{C}$



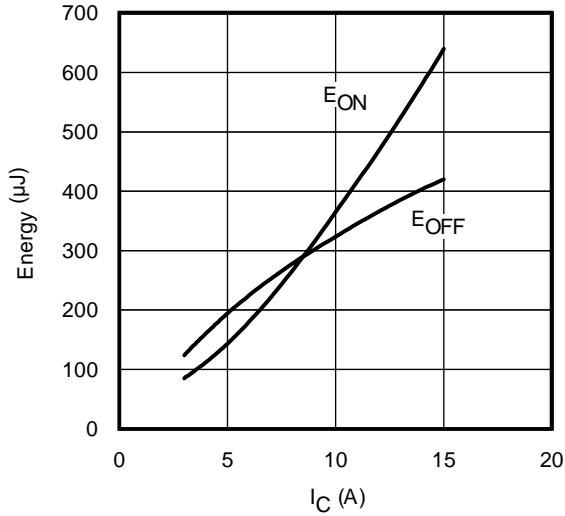
**Fig. 11** - Typical  $V_{CE}$  vs.  $V_{GE}$   
 $T_J = 150^\circ\text{C}$



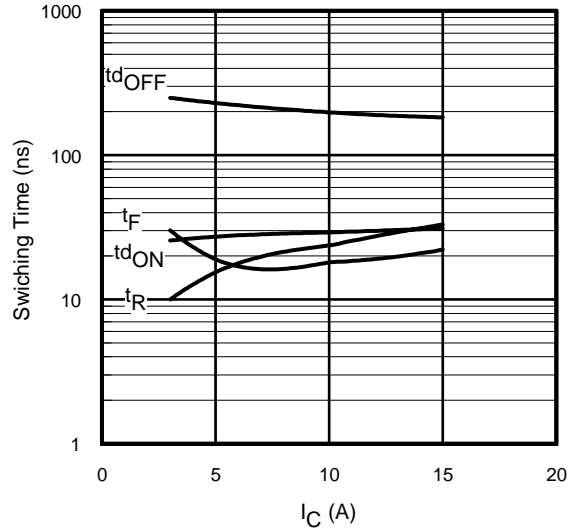
**Fig. 12** - Typ. Transfer Characteristics  
 $V_{CE} = 50\text{V}$ ;  $t_p = 10\mu\text{s}$

# IRGIB6B60KD

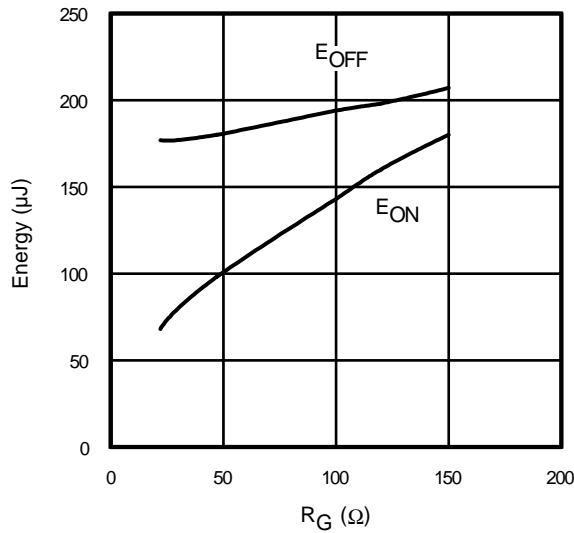
International  
**IR** Rectifier



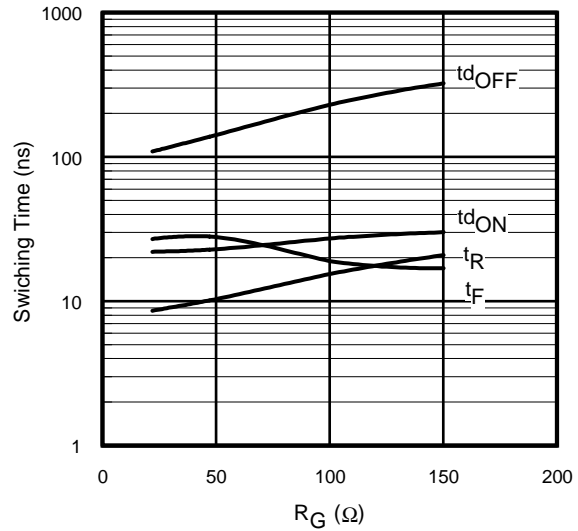
**Fig. 13** - Typ. Energy Loss vs.  $I_C$   
 $T_J = 150^\circ\text{C}$ ;  $L = 1.4\text{mH}$ ;  $V_{CE} = 400\text{V}$   
 $R_G = 100\Omega$ ;  $V_{GE} = 15\text{V}$



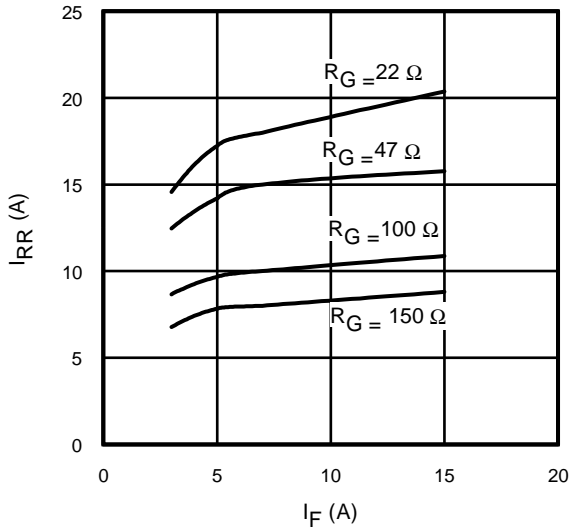
**Fig. 14** - Typ. Switching Time vs.  $I_C$   
 $T_J = 150^\circ\text{C}$ ;  $L = 1.4\text{mH}$ ;  $V_{CE} = 400\text{V}$   
 $R_G = 100\Omega$ ;  $V_{GE} = 15\text{V}$



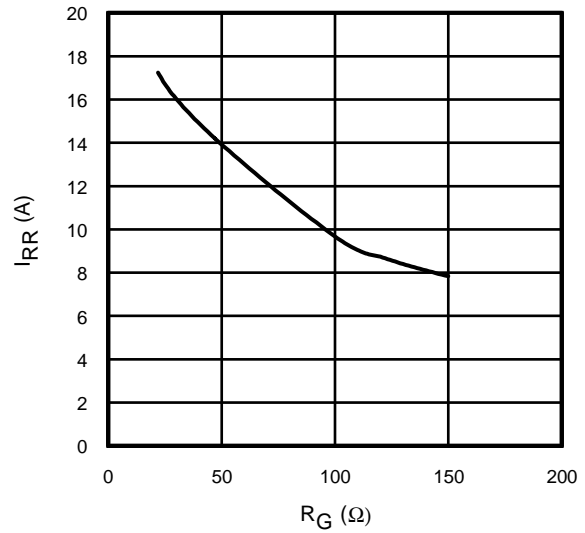
**Fig. 15** - Typ. Energy Loss vs.  $R_G$   
 $T_J = 150^\circ\text{C}$ ;  $L = 1.4\text{mH}$ ;  $V_{CE} = 400\text{V}$   
 $I_{CE} = 5.0\text{A}$ ;  $V_{GE} = 15\text{V}$



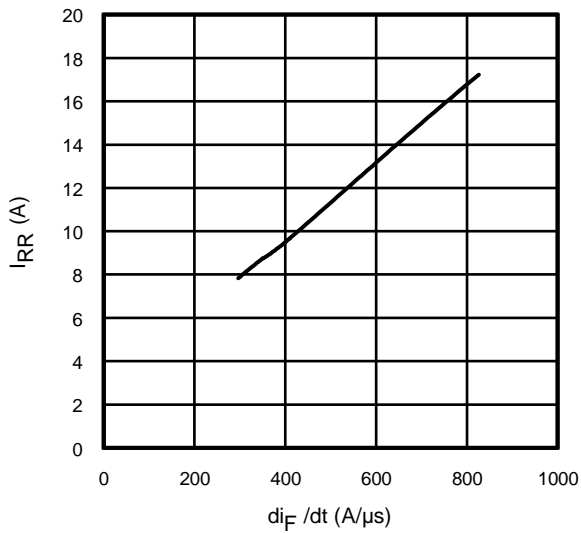
**Fig. 16** - Typ. Switching Time vs.  $R_G$   
 $T_J = 150^\circ\text{C}$ ;  $L = 1.4\text{mH}$ ;  $V_{CE} = 400\text{V}$   
 $I_{CE} = 5.0\text{A}$ ;  $V_{GE} = 15\text{V}$



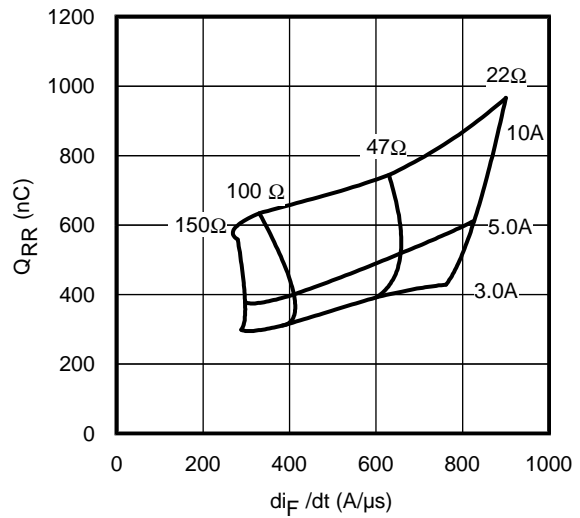
**Fig. 17** - Typical Diode  $I_{RR}$  vs.  $I_F$   
 $T_J = 150^\circ\text{C}$



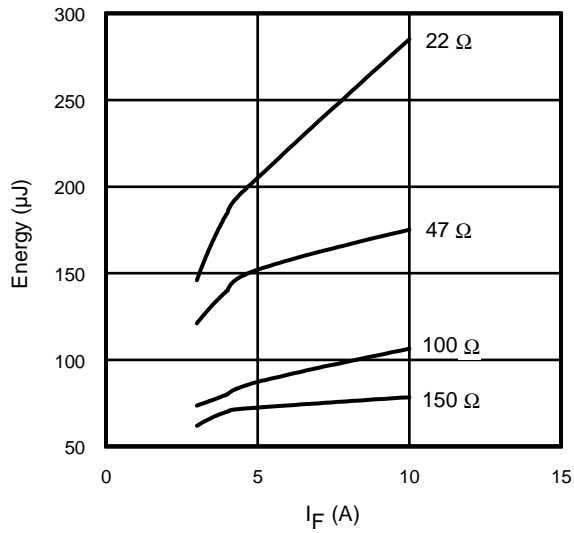
**Fig. 18** - Typical Diode  $I_{RR}$  vs.  $R_G$   
 $T_J = 150^\circ\text{C}; I_F = 5.0\text{A}$



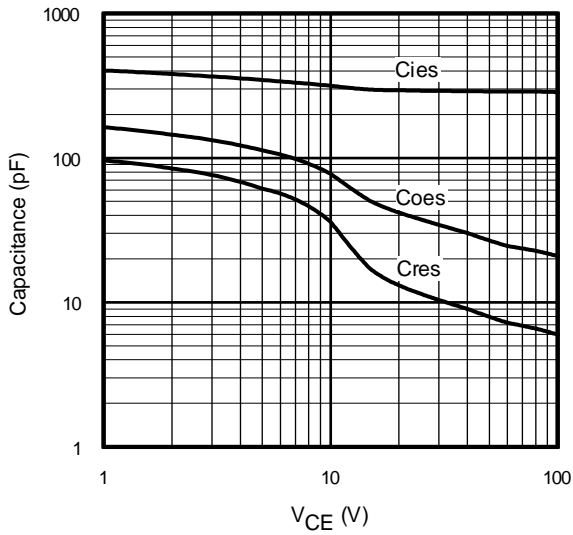
**Fig. 19**- Typical Diode  $I_{RR}$  vs.  $di_F/dt$   
 $V_{CC} = 400\text{V}; V_{GE} = 15\text{V};$   
 $I_{CE} = 5.0\text{A}; T_J = 150^\circ\text{C}$



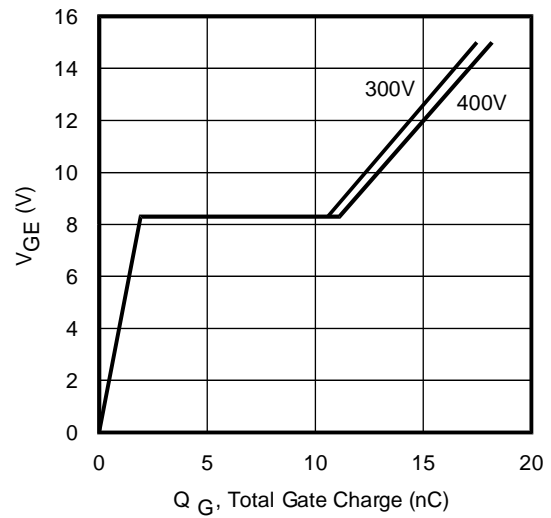
**Fig. 20** - Typical Diode  $Q_{RR}$   
 $V_{CC} = 400\text{V}; V_{GE} = 15\text{V}; T_J = 150^\circ\text{C}$



**Fig. 21** - Typical Diode  $E_{RR}$  vs.  $I_F$   
 $T_J = 150^\circ\text{C}$



**Fig. 22**- Typ. Capacitance vs.  $V_{CE}$   
 $V_{GE} = 0\text{V}$ ;  $f = 1\text{MHz}$



**Fig. 23** - Typical Gate Charge vs.  $V_{GE}$   
 $I_{CE} = 5.0\text{A}$ ;  $L = 600\mu\text{H}$



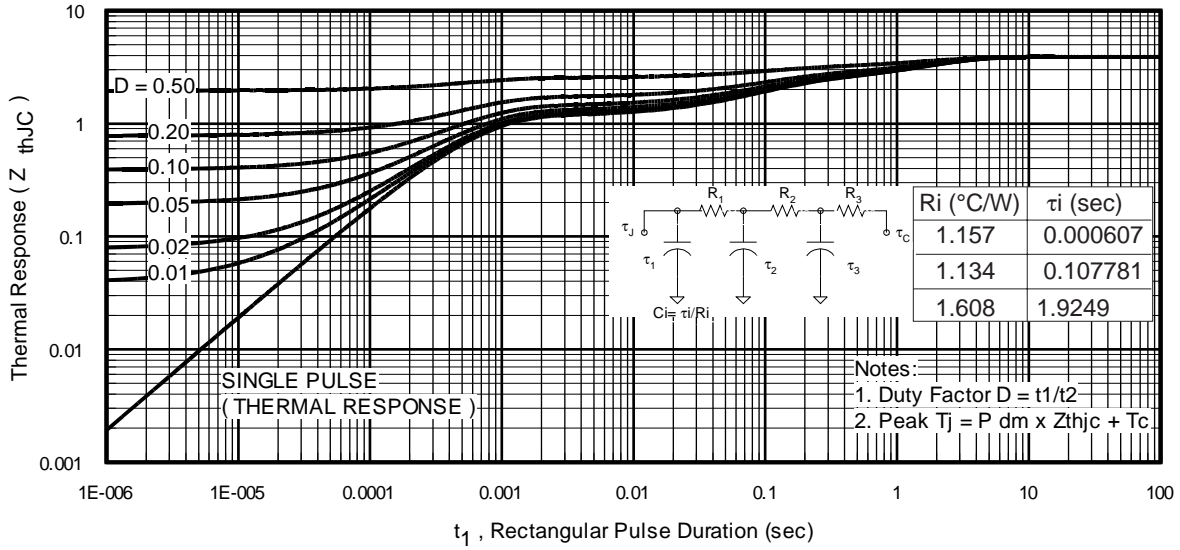


Fig 24. Maximum Transient Thermal Impedance, Junction-to-Case (IGBT)

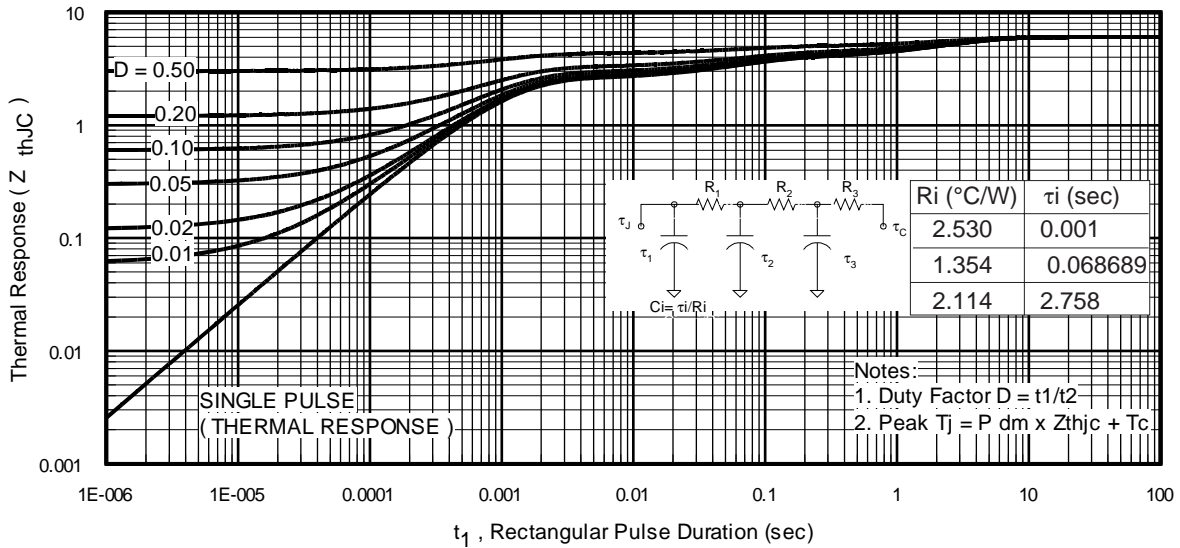
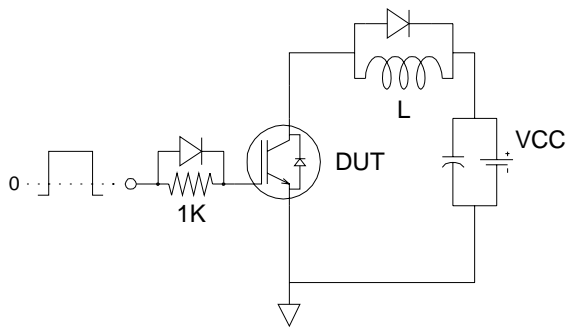


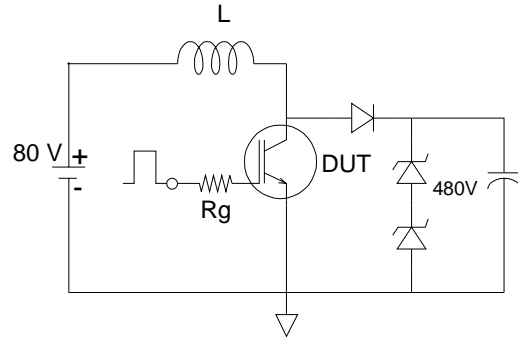
Fig 25. Maximum Transient Thermal Impedance, Junction-to-Case (DIODE)

# IRGIB6B60KD

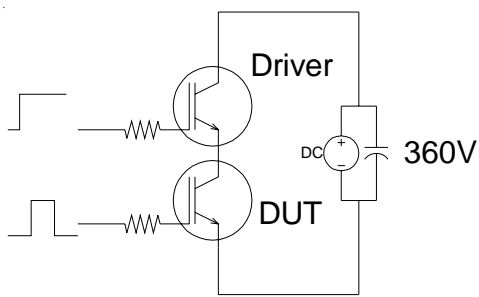
International  
**IR** Rectifier



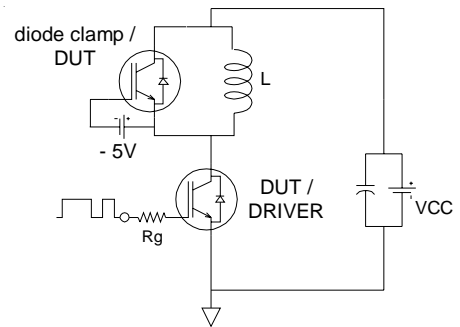
**Fig.C.T.1 - Gate Charge Circuit (turn-off)**



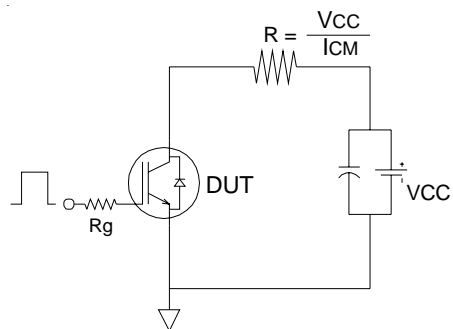
**Fig.C.T.2 - RBSOA Circuit**



**Fig.C.T.3 - S.C.SOA Circuit**



**Fig.C.T.4 - Switching Loss Circuit**



**Fig.C.T.5 - Resistive Load Circuit**

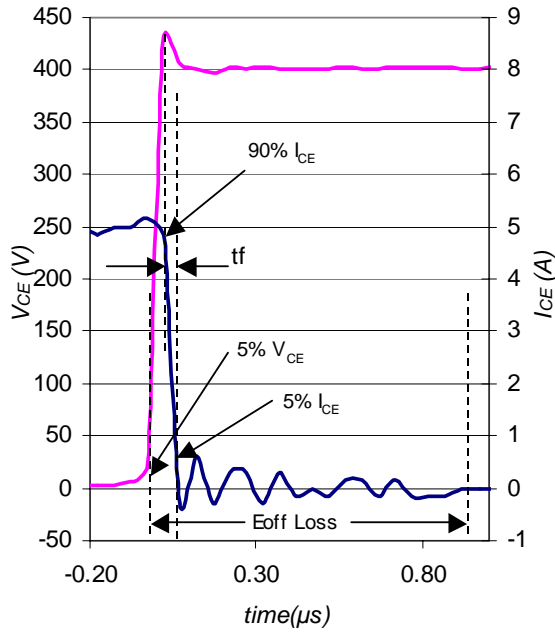


Fig. WF1- Typ. Turn-off Loss Waveform  
@  $T_J = 150^\circ C$  using Fig. CT.4

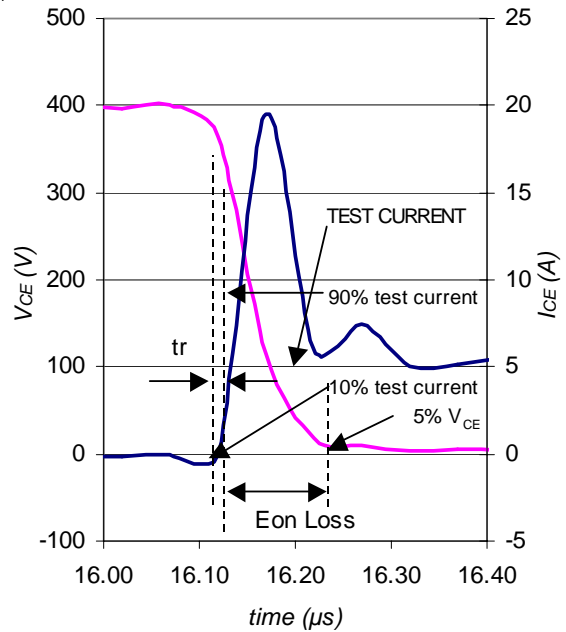


Fig. WF2- Typ. Turn-on Loss Waveform  
@  $T_J = 150^\circ C$  using Fig. CT.4

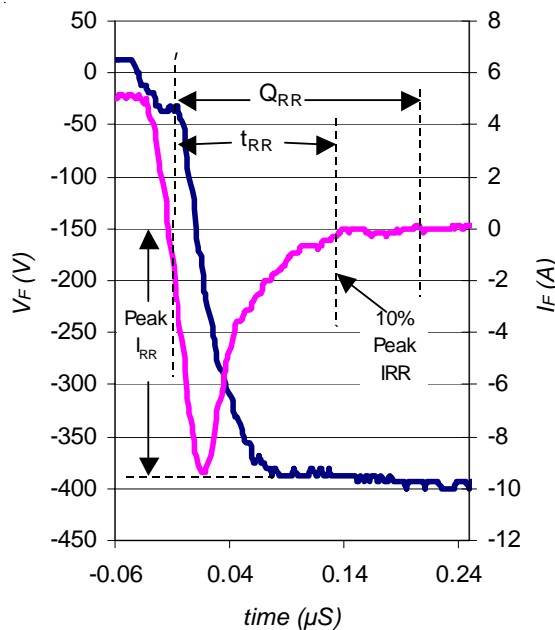


Fig. WF3- Typ. Diode Recovery Waveform  
@  $T_J = 150^\circ C$  using Fig. CT.4

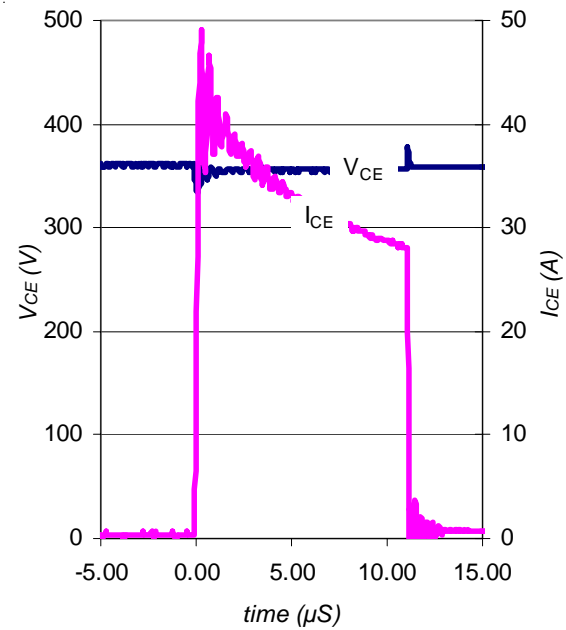


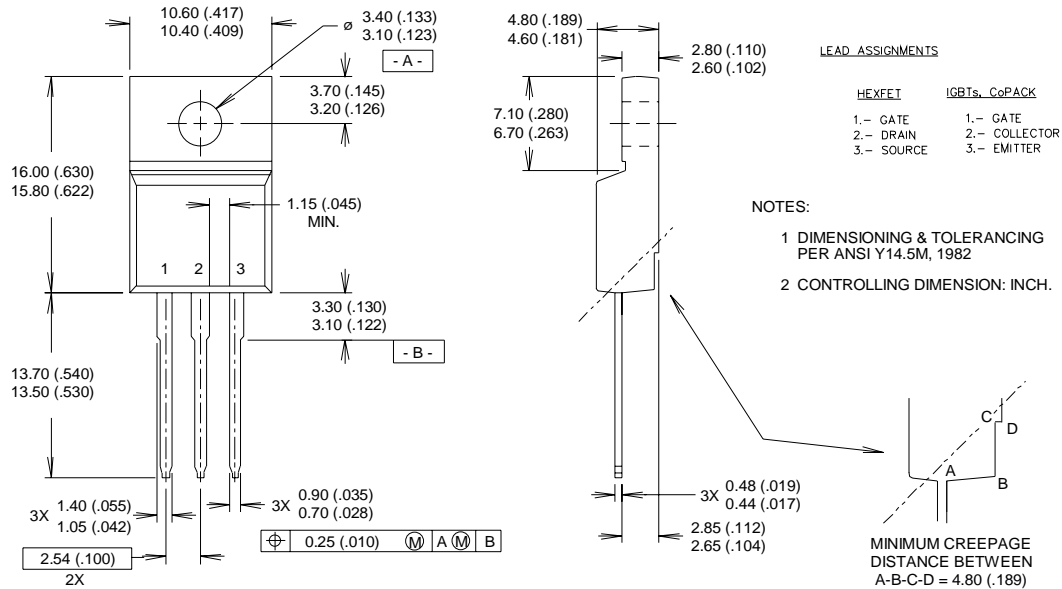
Fig. WF4- Typ. S.C. Waveform  
@  $T_J = 150^\circ C$  using Fig. CT.3

# IRGIB6B60KD

International  
**IR** Rectifier

## TO-220 Full-Pak Package Outline

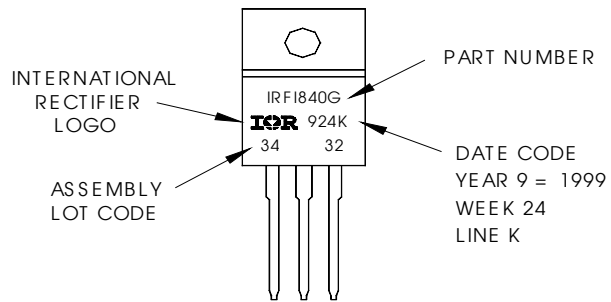
Dimensions are shown in millimeters (inches)



## TO-220 Full-Pak Part Marking Information

EXAMPLE: THIS IS AN IRF1840G  
WITH ASSEMBLY  
LOT CODE 3432  
ASSEMBLED ON WW 24 1999  
IN THE ASSEMBLY LINE "K"

**Note:** "P" in assembly line position indicates "Lead-Free"



TO-220 Full-Pak package is not recommended for Surface Mount Application

Data and specifications subject to change without notice.  
This product has been designed and qualified for the Industrial market.  
Qualification Standards can be found on IR's Web site.

International  
**IR** Rectifier

**IR WORLD HEADQUARTERS:** 233 Kansas St., El Segundo, California 90245, USA Tel: (310) 252-7105  
TAC Fax: (310) 252-7903

Visit us at [www.irf.com](http://www.irf.com) for sales contact information.4/04