

- ◆ 2ch DC/DC Controller (Step-up + Inverting)
- ◆ Input Voltage Range 0.9V ~ 10.0V
- ◆ Output Voltage Externally Set-Up
- ◆ Oscillation Frequency 180kHz (±15%)
- ◆ Max Duty Ratio 80% (TYP)
- ◆ PWM, PWM/PFM Switching Control
- ◆ MSOP-10 Package

General Description

The XC9504 series are PWM control, PWM/PFM switching, 2 channel (step-up and inverting) DC/DC controller ICs. With 0.9V of standard voltage supply internal, and using externally connected components, the output 1 voltage (step-up DC/DC controller) can be set freely within a range of 1.5V ~ 30V. Since output 2 (inverting DC/DC controller) has a built-in 0.9V reference voltage (accuracy ±2), a negative voltage can be set with the external components. With a 180kHz frequency, the size of the external components can be reduced. Switching frequencies of 300kHz and 500kHz are also available as custom-designed products. The control of the XC9504 series can be switched between PWM control and PWM/PFM automatic switching control using external signals. Control switches from PWM to PFM during light loads when automatic switching is selected and the series is highly efficient from light loads through to large output currents. Noise is easily reduced with PWM control since the frequency is fixed. The series gives freedom of control selection so that control suited to the application can be selected. Soft-start time is internally set to 10msec (output 1)

which offers protection against rush currents and voltage overshoot when the power is switched on .

Applications

- Power Supplies for LCD
- PDAs
- Palm Top Computers
- Portable Audio Systems
- Various Multi-function Power Supplies

Features

2ch. DC/DC Controllers

- Output 1: Step-up DC/DC Controller
- Output 2: Inverting DC/DC Controller

Power Supply Voltage Range 2.0V ~ 10V

Output Voltage Range

- | | |
|---|--|
| Output 1:
(Step-up DC/DC Controller) | 1.5V ~ 30.0V
Can be set freely with 0.9V(±2.0%) of reference voltage supply & external components |
| Output 2:
(Inverting DC/DC Controller) | -30V ~ 0V
Can be set freely with 0.9V(±2.0%) of reference voltage & external components |

Oscillation Frequency 180kHz ±15%
300kHz & 500kHz are available as custom

Output Current Output 1 : more than 20mA (VIN=3.3V, VOUT=15V)
Output 2 : more than -20mA (VIN=3.3V, VOUT=-7V)

Soft-Start Internally Set-Up (Output 1)

Stand-By Current 3.0µA (MAX)

Typical Performance Characteristics

XC9504B092A

(180kHz, Output 1 = 15V, Output 2 = -7.5V)
L1=22µH (CDRH4D18C), CL1= 10µF (ceramic), SD1: CRS02, Tr1:XP151A12A2M
L2=22µH (CDRH4D18C), CL2= 10µF (ceramic), SD1: CRS02, Tr2:XP152A12C0M

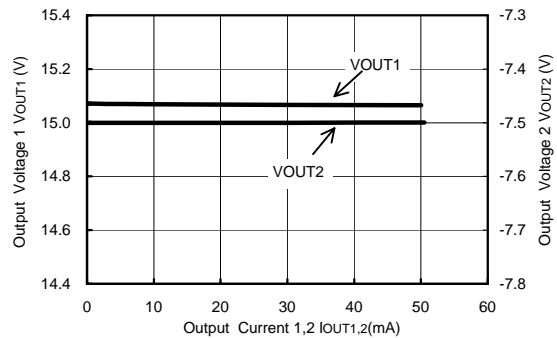

Typical Application

(XC9504B092A Input: 3.3V, Output ①: 15V, Output ②: -7V)

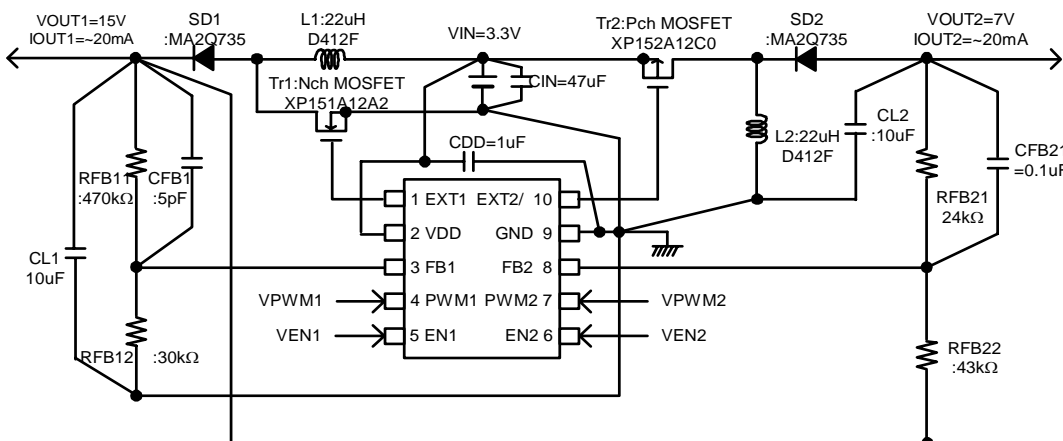

■ Pin Configuration

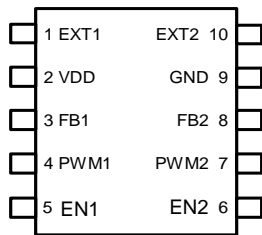

MSOP-10
(TOP VIEW)

■ Pin Assignment

PIN NUMBER	PIN NAME	FUNCTIONS
1	EXT 1	Channel 1: External Transistor Drive Pin <Connected to Nch Power MOSFET Gate>
2	VDD	Supply Voltage
3	FB1	Channel 1 : Output Voltage Monitor Feedback Pin <Threshold value : 0.9V. Output voltage can be set freely by connecting split resistors between VOUT1 and Ground.>
4	PWM1	Channel 1 : PWM/PFM Switching Pin <Control Output 1. PWM control when connected to VDD, PWM / PFM auto switching when connected to Ground. >
5	EN1	Channel 1 : Enable Pin <Connected to Ground when Output 1 is in stand-by mode. Connected to VDD when Output 1 is active. EXT1 is low when in stand-by mode.>
6	EN2	Channel 2 : Enable Pin <Connected to Ground when Output 2 is in stand-by mode. Connected to VDD when Output 2 is active. EXT2/ is high when in stand-by mode.>
7	PWM2	Channel 2 : PWM/PFM Switching Pin <Control Output 2. PWM control when connected to VDD, PWM / PFM auto switching when connected to Ground.>
8	FB2	Channel 2 : Output Voltage Monitor Feedback Pin <Threshold value : 0.9V. Output voltage can be set freely by connecting split resistors between VOUT2 and Ground.>
9	GND	Ground
10	EXT2/	Channel 2 : External Transistor Drive Pin <Connected to Pch Power MOSFET Gate>

■ Ordering Information

XC9504①②③④⑤⑥

DESIGNATOR	SYMBOL	DESCRIPTION
①	B	Standard (10 Pin)
②	0	FB Voltage
③	9	0.9V
④		Oscillation Frequency
	2	180kHz
	3	300kHz (custom)
	5	500kHz (custom)
⑤	A	Package MSOP-10
⑥	R	Embossed Tape Standard Feed
	L	Embossed Tape Reverse Feed

■ Block Diagram

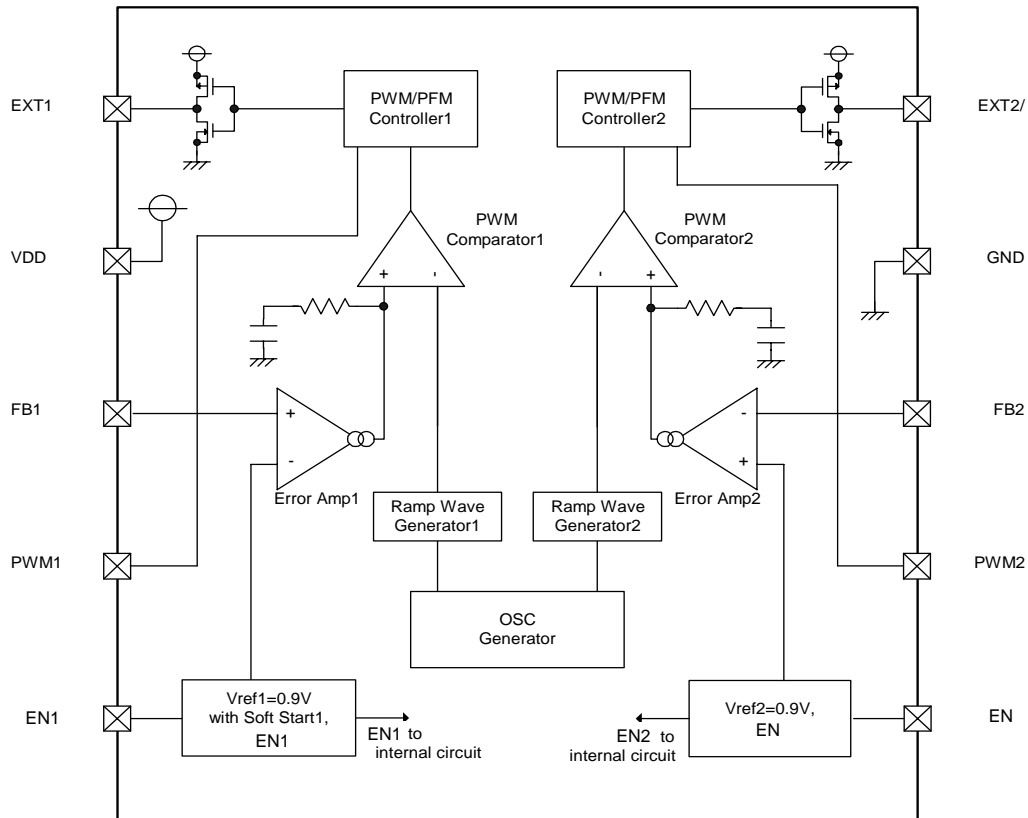

■ Absolute Maximum Ratings

Ta=25°C

PARAMETER	SYMBOL	RATINGS	UNITS
VDD Pin Voltage	VDD	- 0.3 ~ 12	V
FB1, 2 Pin Voltage	VFB	- 0.3 ~ 12	V
EN1, 2 Pin Voltage	VEN	- 0.3 ~ 12	V
PWM1,2 Pin Voltage	VPWM	- 0.3 ~ 12	V
EXT1, 2 Pin Voltage	VEXT	- 0.3 ~ VDD + 0.3	V
EXT1, 2 Pin Current	IEXT	± 100	mA
Power Dissipation	Pd	150	mW
Operating Ambient Temperature	Topr	- 40 ~ + 85	°C
Storage Temperature	Tstg	- 55 ~ + 125	°C

Electrical Characteristics

XC9504B092A

Common Characteristics

Ta=25°C

PARAMETER	SYMBOL	CONDITIONS	MIN.	TYP.	MAX.	UNITS	TEST CIRCUIT	
Supply Voltage (note 1)	VDD		2.0	-	10.0	V		
Output Voltage Range (note 3)	VOUTSET	VDD ≥ 2.0V, IOUT=1mA	VOUT1	0.9	-	-	V	①
		VDD ≠ VOUT	VOUT2	-	-	0.0		
		VIN ≥ 0.9V, IOUT=1mA (note 2)	VOUT1	2.0	-	10.0	V	②
		VDD=VOUT	VOUT2	-	-	0.0		
Supply Current 1	IDD1	FB=0V, FB2=1.2V	-	90	190	μA	③	
Supply Current 1-1	IDD1-1	EN1=3.0V, EN2=0, FB1=0V EN2=3.0V, EN1=0V, FB2=1.2V	-	60	120	μA	③	
Supply Current 1-2	IDD1-2	FB1=0V, FB2=0V FB1=1.2V, FB2=1.2V	-	80	150	μA	③	
Supply Current 2	IDD2	FB1=1.2V, FB2=0V	-	70	132	μA	③	
Stand-by Current	ISTB	Same as IDD1, EN1=EN2=0V	-	1	3.0	μA	③	
Oscillation Frequency	FOSC	Same as IDD1	153	180	207	kHz	③	
EN1, 2 "High" Voltage	VENH	FB1=0V, FB2=3.0V	0.65	-	-	V	③	
EN1, 2 "Low" Voltage	VENL	FB1=0V, FB2=3.0V	-	-	0.20	V	③	
EN1, 2 "High" Current	IENH	FB1=3.0V, FB2=0V	-	-	0.50	μA	③	
EN1, 2 "Low" Current	IENL	EN1, 2=0V, FB1=3.0V, FB2=0V	-	-	-0.50	μA	③	
PWM1, 2 "High" Current	IPWMH	FB1=3.0V, FB2=0V, PWM1, 2=3.0V	-	-	0.50	μA	③	
PWM1, 2 "Low" Current	IPWML	FB1=3.0V, FB2=0V, PWM1, 2=0V	-	-	-0.50	μA	③	
FB1, 2 "High" Current	IFBH	FB1=3.0V, FB2=0.8V	-	-	0.50	μA	③	
FB1, 2 "Low" Current	VFBL	FB1=1.0V, FB2=0V	-	-	-0.50	μA	③	

Unless otherwise stated, VDD=3.0V, PWM1, 2=3.0V, EN1, 2 = 3.0V

Output 1 Characteristics

Step-up Controller

Ta=25°C

PARAMETER	SYMBOL	CONDITIONS	MIN.	TYP.	MAX.	UNITS	TEST CIRCUIT
FB1 Voltage	VFB1	VDD=3.0V, VIN=1.5V, IOUT1=10mA	0.882	0.900	0.918	V	④
Operation Start-up Voltage1 (note 2)	VST1-1	Using Tr: 2SD1628, IOUT=1.0mA, RFB11=200kΩ, RFB12=75kΩ	-	-	0.9	V	②
		VDD ≠ VOUT1 : IOUT1=10mA	-	-	2.0	V	①
Oscillation Start-up Voltage1	VST2-1	FB1=0V	-	-	0.8	V	③
Maximum Duty Ratio1	MINDTY1	Same as IDD1	75	80	87	%	③
Minimum Duty Ratio1	MAXDTY2	Same as IDD2	-	-	0	%	③
PFM Duty Ratio1	PFMDTY1	No Load, VPWM1=0V	22	30	38	%	⑤
Efficiency1	EFFI1	IOUT1= 130mA, Nch MOSFET: XP161A1355P	-	85	-	%	⑤
Soft-Start Time1	TSS1	VOUT1 × 0.95V, EN1=0V→0.65V	5.0	10.0	20.0	msec	⑤
EXT1 "High" ON Resistance	REXTBH1	FB1=0V, EXT1=VDD -0.4V	-	28	47	Ω	⑥
EXT1 "Low" ON Resistance	REXTBL1	EN1=FB1=1.2V, EXT1=0.4V	-	22	30	Ω	⑥
PWM1 "High" Voltage	VPWMH1	No Load	0.65	-	-	V	⑤
PWM1 "Low" Voltage	VPWML1	No Load	-	-	0.20	V	⑤

Unless otherwise stated, VDD=EN1=PWM1=3.0V, EN2=PWM2=GND, EXT2=OPEN, FB2=OPEN, VIN=1.8V

Output 2 Characteristics

Inverting DC/DC Controller

Ta=25°C

PARAMETER	SYMBOL	CONDITIONS	MIN.	TYP.	MAX.	UNITS	TEST CIRCUIT
FB2 Voltage	VFB2	VDD=3.0V	0.882	0.900	0.918	V	③
Operation Start-up Voltage2	VST1-2	IOUT2=1.0mA, RFB11=200kΩ, RFB12=75kΩ	-	-	2.0	V	① ②
		RFB21=17.5kΩ, RFB22=10kΩ, EN1=PWM1=3.0V	-	-	2.0	V	
Oscillation Start-up Voltage2	VST2-2	FB2=1.2V	-	-	2.0	V	③
Maximum Duty Ratio2	MAXDTY2	Same as IDD1	75	80	87	%	③
Minimum Duty Ratio2	MINDTY3	Same as IDD2	-	-	0	%	③
PFM Duty Ratio2	PFMDTY2	No Load, VPWM2=0V	22	30	38	%	⑦
Efficiency2 (Note 4)	EFFI2	IOUT2= -150mA, Pch MOSFET: XP162A12A6P	-	76	-	%	⑦
EXT2 "High" ON Resistance	REXTBH2	EN2=FB2= 0V, EXT2=VDD-0.4V	-	28	47	Ω	⑥
EXT2 "Low" ON Resistance	REXTBL2	FB2=3.0V, EXT2=0.4V	-	22	30	Ω	⑥
PWM2 "High" Voltage	VPWMH2	No Load	0.65	-	-	V	⑦
PWM2 "Low" Voltage	VPWML2	No Load	-	-	0.20	V	⑦

Unless otherwise stated, VDD=EN2=PWM2=3.0V, PWM1=EN1=GND, EXT1=OPEN, FB1=OPEN, VIN=3.0V

Electrical Characteristics

XC9504B093A

Common Characteristics

Ta=25°C

PARAMETER	SYMBOL	CONDITIONS	MIN.	TYP.	MAX.	UNITS	TEST CIRCUIT	
Supply Voltage (note 1)	VDD		2.0	-	10.0	V		
Output Voltage Range (note 3)	VOUTSET	VDD ≥ 2.0V, IOUT=1mA	VOUT1	0.9	-	-	V	①
		VDD ≠ VOUT	VOUT2	-	-	0.0		
		VIN ≥ 0.9V, IOUT=1mA (note 2)	VOUT1	2.0	-	10.0	V	②
		VDD=VOUT	VOUT2	-	-	0.0		
Supply Current 1	IDD1	FB=0V, FB2=1.2V	-	110	250	μA	③	
Supply Current 1-1	IDD1-1	EN1=3.0V, EN2=0, FB1=0V	-	80	150	μA	③	
		EN2=3.0V, EN1=0V, FB2=1.2V						
Supply Current 1-2	IDD1-2	FB1=0V, FB2=0V	-	90	200	μA	③	
		FB1=1.2V, FB2=1.2V						
Supply Current 2	IDD2	FB1=1.2V, FB2=0V	-	80	160	μA	③	
Stand-by Current	ISTB	Same as IDD1, EN1=EN2=0V	-	1.0	3.0	μA	③	
Oscillation Frequency	FOSC	Same as IDD1	255	300	345	kHz	③	
EN1, 2 "High" Voltage	VENH	FB1=0V, FB2=3.0V	0.65	-	-	V	③	
EN1, 2 "Low" Voltage	VENL	FB1=0V, FB2=3.0V	-	-	0.20	V	③	
EN1, 2 "High" Current	IENH	FB1=3.0V, FB2=0V	-	-	0.50	μA	③	
EN1, 2 "Low" Current	IENL	EN1, 2=0V, FB1=3.0V, FB2=0V	-	-	-0.50	μA	③	
PWM1, 2 "High" Current	IPWMH	FB1=3.0V, FB2=0V, PWM1, 2=3.0V	-	-	0.50	μA	③	
PWM1, 2 "Low" Current	IPWML	FB1=3.0V, FB2=0V, PWM1, 2=0V	-	-	-0.50	μA	③	
FB1, 2 "High" Current	IFBH	FB1=3.0V, FB2=0.8V	-	-	0.50	μA	③	
FB1, 2 "Low" Current	VFBL	FB1=1.0V, FB2=0V	-	-	-0.50	μA	③	

Unless otherwise stated, VDD=3.0V, PWM1, 2=3.0V, EN1, 2 = 3.0V

Output 1 Characteristics

Step-up Controller

Ta=25°C

PARAMETER	SYMBOL	CONDITIONS	MIN.	TYP.	MAX.	UNITS	TEST CIRCUIT
FB1 Voltage	VFB1	VDD=3.0V, VIN=1.5V, IOUT1=10mA	0.882	0.900	0.918	V	④
Operation Start-up Voltage1 (note 2)	VST1-1	Using Tr: 2SD1628, IOUT=1.0mA, RFB11=200kΩ, RFB12=75kΩ	-	-	0.9	V	②
		VDD ≠ VOUT1 : IOUT1=10mA	-	-	2.0	V	①
Oscillation Start-up Voltage1	VST2-1	FB1=0V	-	-	0.8	V	③
Maximum Duty Ratio1	MINDTY1	Same as IDD1	75	80	87	%	③
Minimum Duty Ratio1	MAXDTY2	Same as IDD2	-	-	0	%	③
PFM Duty Ratio1	PFMDTY1	No Load, VPWM1=0V	22	30	38	%	⑤
Efficiency1	EFFI1	IOUT1= 130mA, Nch MOSFET: XP161A1355P	-	85	-	%	⑤
Soft-Start Time1	TSS1	VOUT1 × 0.95V, EN1=0V → 0.65V	5.0	10.0	20.0	msec	⑤
EXT1 "High" ON Resistance	REXTBH1	FB1=0V, EXT1=VDD -0.4V	-	28	47	Ω	⑥
EXT1 "Low" ON Resistance	REXTBL1	EN1=FB1=1.2V, EXT1=0.4V	-	22	30	Ω	⑥
PWM1 "High" Voltage	VPWMH1	No Load	0.65	-	-	V	⑤
PWM1 "Low" Voltage	VPWML1	No Load	-	-	0.20	V	⑤

Unless otherwise stated, VDD=EN1=PWM1=3.0V, EN2=PWM2=GND, EXT2=OPEN, FB2=OPEN, VIN=1.8V

Output 2 Characteristics

Inverting DC/DC Controller

Ta=25°C

PARAMETER	SYMBOL	CONDITIONS	MIN.	TYP.	MAX.	UNITS	TEST CIRCUIT
FB2 Voltage	VFB2	VDD=3.0V	0.882	0.900	0.918	V	③
Operation Start-up Voltage2	VST1-2	IOUT2=1.0mA, RFB11=200kΩ, RFB12=75kΩ	-	-	2.0	V	① ②
		RFB21=17.5kΩ, RFB22=10kΩ, EN1=PWM1=3.0V					
Oscillation Start-up Voltage2	VST2-2	FB2=1.2V	-	-	2.0	V	③
Maximum Duty Ratio2	MAXDTY2	Same as IDD1	75	80	87	%	③
Minimum Duty Ratio2	MINDTY3	Same as IDD2	-	-	0	%	③
PFM Duty Ratio2	PFMDTY2	No Load, VPWM2=0V	22	30	38	%	⑦
Efficiency2 (Note 4)	EFFI2	IOUT2= -150mA, Pch MOSFET: XP162A12A6P	-	75	-	%	⑦
EXT2 "High" ON Resistance	REXTBH2	EN2=FB2= 0V, EXT2=VDD-0.4V	-	28	47	Ω	⑥
EXT2 "Low" ON Resistance	REXTBL2	FB2=3.0V, EXT2=0.4V	-	22	30	Ω	⑥
PWM2 "High" Voltage	VPWMH2	No Load	0.65	-	-	V	⑦
PWM2 "Low" Voltage	VPWML2	No Load	-	-	0.20	V	⑦

Unless otherwise stated, VDD=EN2=PWM2=3.0V, PWM1=EN1=GND, EXT1=OPEN, FB1=OPEN, VIN=3.0V

Electrical Characteristics

XC9504B095A

Common Characteristics

Ta=25°C

PARAMETER	SYMBOL	CONDITIONS	MIN.	TYP.	MAX.	UNITS	TEST CIRCUIT	
Supply Voltage (note 1)	VDD		2.0	-	10.0	V		
Output Voltage Range (note 3)	VOUTSET	VDD ≥ 2.0V, IOUT=1mA	VOUT1	0.9	-	-	V	①
		VDD ≠ VOUT	VOUT2	-	-	0.0		
		VIN ≥ 0.9V, IOUT=1mA (note 2)	VOUT1	2.0	-	10.0	V	②
		VDD=VOUT	VOUT2	-	-	0.0		
Supply Current 1	IDD1	FB=0V, FB2=1.2V	-	165	350	μA	③	
Supply Current 1-1	IDD1-1	EN1=3.0V, EN2=0, FB1=0V	-	110	220	μA	③	
		EN2=3.0V, EN1=0V, FB2=1.2V						
Supply Current 1-2	IDD1-2	FB1=0V, FB2=0V	-	130	270	μA	③	
		FB1=1.2V, FB2=1.2V						
Supply Current 2	IDD2	FB1=1.2V, FB2=0V	-	100	200	μA	③	
Stand-by Current	ISTB	Same as IDD1, EN1=EN2=0V	-	1.0	3.0	μA	③	
Oscillation Frequency	FOSC	Same as IDD1	425	500	575	kHz	③	
EN1, 2 "High" Voltage	VENH	FB1=0V, FB2=3.0V	0.65	-	-	V	③	
EN1, 2 "Low" Voltage	VENL	FB1=0V, FB2=3.0V	-	-	0.20	V	③	
EN1, 2 "High" Current	IENH	FB1=3.0V, FB2=0V	-	-	0.50	μA	③	
EN1, 2 "Low" Current	IENL	EN1, 2=0V, FB1=3.0V, FB2=0V	-	-	-0.50	μA	③	
PWM1, 2 "High" Current	IPWMH	FB1=3.0V, FB2=0V, PWM1, 2=3.0V	-	-	0.50	μA	③	
PWM1, 2 "Low" Current	IPWML	FB1=3.0V, FB2=0V, PWM1, 2=0V	-	-	-0.50	μA	③	
FB1, 2 "High" Current	IFBH	FB1=3.0V, FB2=0.8V	-	-	0.50	μA	③	
FB1, 2 "Low" Current	VFBL	FB1=1.0V, FB2=0V	-	-	-0.50	μA	③	

Unless otherwise stated, VDD=3.0V, PWM1, 2=3.0V, EN1, 2 = 3.0V

Output 1 Characteristics

Step-up Controller

Ta=25°C

PARAMETER	SYMBOL	CONDITIONS	MIN.	TYP.	MAX.	UNITS	TEST CIRCUIT
FB1 Voltage	VFB	VDD=3.0V, VIN=1.5V, IOUT1=10mA	0.882	0.900	0.918	V	④
Operation Start-up Voltage1 (note 2)	VST1-1	Using Tr: 2SD1628, IOUT=1.0mA, RFB11=200kΩ, RFB12=75kΩ	-	-	0.9	V	②
		VDD ≠ VOUT1 : IOUT1=10mA	-	-	2.0	V	①
Oscillation Start-up Voltage1	VST2-1	FB1=0V	-	-	0.8	V	③
Maximum Duty Ratio1	MINDTY1	Same as IDD1	75	80	87	%	③
Minimum Duty Ratio1	MAXDTY2	Same as IDD2	-	-	0	%	③
PFM Duty Ratio1	PFMDTY1	No Load, VPWM1=0V	22	30	38	%	⑤
Efficiency1	EFFI1	IOUT1= 130mA, Nch MOSFET: XP161A1355P	-	83	-	%	⑤
Soft-Start Time1	TSS1	VOUT1 × 0.95V, EN1=0V→0.65V	5.0	10.0	20.0	msec	⑤
EXT1 "High" ON Resistance	REXTBH1	FB1=0V, EXT1=VDD -0.4V	-	28	47	Ω	⑥
EXT1 "Low" ON Resistance	REXTBL1	EN1=FB1=1.2V, EXT1=0.4V	-	22	30	Ω	⑥
PWM1 "High" Voltage	VPWMH1	No Load	0.65	-	-	V	⑤
PWM1 "Low" Voltage	VPWML1	No Load	-	-	0.20	V	⑤

Unless otherwise stated, VDD=EN1=PWM1=3.0V, EN2=PWM2=GND, EXT2=OPEN, FB2=OPEN, VIN=1.8V

Output 2 Characteristics

Inverting DC/DC Controller

Ta=25°C

PARAMETER	SYMBOL	CONDITIONS	MIN.	TYP.	MAX.	UNITS	TEST CIRCUIT
FB2 Voltage	VFB	VDD=3.0V	0.882	0.900	0.918	V	③
Operation Start-up Voltage2	VST1-2	IOUT2=1.0mA, RFB11=200kΩ, RFB12=75kΩ	-	-	2.0	V	① ②
		RFB21=17.5kΩ, RFB22=10kΩ, EN1=PWM1=3.0V					
Oscillation Start-up Voltage2	VST2-2	FB2=1.2V	-	-	2.0	V	③
Maximum Duty Ratio2	MAXDTY2	Same as IDD1	75	80	87	%	③
Minimum Duty Ratio2	MINDTY3	Same as IDD2	-	-	0	%	③
PFM Duty Ratio2	PFMDTY2	No Load, VPWM2=0V	22	30	38	%	⑦
Efficiency2 (Note 4)	EFFI2	IOUT2= -150mA, Pch MOSFET: XP162A12A6P	-	71	-	%	⑦
EXT2 "High" ON Resistance	REXTBH2	EN2=FB2= 0V, EXT2=VDD-0.4V	-	28	47	Ω	⑥
EXT2 "Low" ON Resistance	REXTBL2	FB2=3.0V, EXT2=0.4V	-	22	30	Ω	⑥
PWM2 "High" Voltage	VPWMH2	No Load	0.65	-	-	V	⑦
PWM2 "Low" Voltage	VPWML2	No Load	-	-	0.20	V	⑦

Unless otherwise stated, VDD=EN2=PWM2=3.0V, PWM1=EN1=GND, EXT1=OPEN, FB1=OPEN, VIN=3.0V

Notes

- 1) Although the IC's step-up operations start from a VDD of 0.8V, the output voltage and switching frequency are stabilized at VDD \geq 2.0V. Therefore, a VDD of more than 2.0V is recommended when VDD is supplied from VIN or other power sources.
- 2) Although the IC's switching operations start from a VIN of 0.9V, the IC's power supply pin (VDD) and output voltage monitor pin (FB1) should be connected to VOUT1. With operations from VIN=0.9V, the 2nd channel's (output 2) EN2 pin should be set to chip disable. Once output voltage VOUT1 is more than 2.0V, the EN2 pin should be set to chip enable.
- 3) Please be careful not to exceed the breakdown voltage level of the peripheral parts.
- 4) $EFF1 = \left\{ \frac{(\text{Output voltage}) \times (\text{Output current})}{(\text{Input voltage}) \times (\text{Input Current})} \right\} \times 100$

■ Typical Application Circuit

XC9504B Series

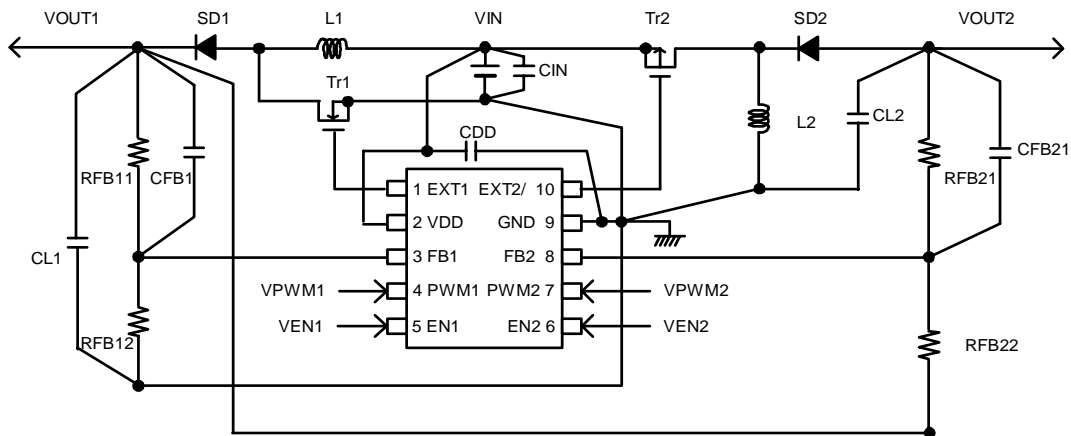

■ Operational Description

The XC9504 series are dual DC/DC (step-up + inverting) converter controller ICs with built-in high speed, low ON resistance buffers.

<Error Amp. 1>

Error Amplifier 1 is designed to monitor the output voltage and it compares the feedback voltage 1 (FB1) with the reference voltage Vref1. In response to feedback of a voltage lower than the reference voltage Vref1, the output voltage of the error amp. decreases.

<Error Amp. 2>

Error Amplifier 2 is designed to monitor the output voltage and it compares the feedback voltage 2 (FB2) with the reference voltage Vref 2. In response to feedback of a voltage lower than the reference voltage Vref2, the output voltage of the error amp. decreases.

<OSC Generator>

This circuit generates the internal reference clock.

<Ramp Wave Generator 1, 2>

The Ramp Wave Generator generates a saw-tooth waveform based on outputs from the OSC Generator.

<PWM Comparator 1, 2>

The PWM Comparator compares outputs from the Error Amp. and saw-tooth waveform. When the voltage from the Error Amp's output is low, the external switch will be set to ON.

<PWM/PFM Controller 1, 2>

This circuit generates PFM pulses.

Control can be switched between PWM control and PWM/PFM automatic switching control using external signals.

The PFM/PWM automatic switching mode is selected when the voltage of the PWM1 (2) pin is less than 0.2V, and the control switches between PWM and PFM automatically depending on the load. As the PFM circuit generates pulses based on outputs from the PWM Comparator, shifting between modes occurs smoothly. PWM control mode is selected when the voltage of the PWM1 (2) pin is more than 0.65V. Noise is easily reduced with PWM control since the switching frequency is fixed.

Control suited to the application can easily be selected which is useful in audio applications, for example, where traditionally, efficiencies have been sacrificed during stand-by as a result of using PWM control (due to the noise problems associated with the PFM mode in stand-by).

<Vref 1 with Soft Start 1>

The reference voltage, Vref1(FB1 pin voltage)=0.9V, is adjusted and fixed by laser trimming (for output voltage settings, please refer to the functional settings notes on page 9.). To protect against inrush current, when the power is switched on, and also to protect against voltage overshoot, soft-start time is set internally to 10ms. It should be noted, however, that this circuit does not protect the load capacitor (CL) from inrush current. With the Vref voltage limited, and depending upon the input to error amp 1, the operation maintains a balance between the two inputs of error amps and controls the EXT pin's ON time so that it doesn't increase more than is necessary.

<Vref 2>

The reference voltage, Vref2 (FB2 pin voltage)=0.9V, is adjusted and fixed by laser trimming.

<Enable Function 1,2>

This function controls the operation and shutdown of the IC. When the voltage of the EN1 or EN2 pins is 0.2V or less, the mode will be disable, the channel's operations will stop and the EXT1 pin will be kept at a low level (the external N-type MOSFET will be OFF) and the EXT2 pin will be kept at a high level (the external P-type MOSFET will be OFF). When both EN1 and EN2 are in a state of chip disable, current consumption will be no more than 3.0 μ A.

When the EN1 or EN2 pin's voltage is 0.65V or more, the mode will be enable and operations will recommence. With channel one (output 1) soft-start, 95% of the set output voltage will be reached within 10msec (TYP) from the moment of enable.

■ Functional Settings

< Output Voltage Setting, Ch.1 (Step-up DC/DC Converter Controller) >

Output voltage can be set by adding external split resistors. Output voltage is determined by the following equation, based on the values of RFB11 and RFB12. The sum of RFB11 and RFB12 should normally be 1 MΩ or less.

$$V_{OUT1} = 0.9 \times (R_{FB11} + R_{FB12}) / R_{FB12}$$

The speed-up capacitor for phase compensation's (CFB1) value should be adjusted using the formula $f_{zfb} = 1 / (2 \times \pi \times C_{FB1} \times R_{FB11})$ so that it equals 12kHz. Depending on the application, the inductance value L, and the load capacity value CL, adjustments to this value are suggested so that the value is somewhere between 1kHz to 50kHz.

[Calculation Example]

When RFB11=470kΩ and RFB12=30kΩ : $V_{OUT1} = 0.9 \times (470k + 30k) / 30k = 15.0V$.

[Typical Example]

VOUT (V)	RFB11 (kΩ)	RFB12 (kΩ)	CFB1 (pF)	VOUT (V)	RFB11 (kΩ)	RFB12 (kΩ)	CFB1 (pF)	VOUT (V)	RFB11 (kΩ)	RFB12 (kΩ)	CFB1 (pF)
1.5	220	330	62	2.7	360	180	33	10.0	680	68	18
1.8	220	220	62	3.0	560	240	24	12.0	160	13	82
2.0	330	330	39	3.3	200	75	62	15.0	470	30	27
2.2	390	390	33	5.0	82	18	160	20.0	470	22	27
2.5	390	390	33	8.0	120	15	100	30.0	390	12	34

< Output Voltage Setting, Ch.2 (Inverting DC/DC Converter) >

Output voltage can be set by adding reference voltage and split resistors externally. Output voltage is determined using the following equation and is based on the values of RFB21 and RFB22. The sum of RFB21 and RFB22 should normally be 500kΩ or less. The equation uses Ch 1's (VOUT1) output voltage calculation method for the reference voltage.

$$V_{OUT2} = (0.9 - V_{OUT1}) \times (R_{FB21} / R_{FB22}) + 0.9V$$

[Calculation Example]

When RFB21=17.5kΩ, RFB22=10kΩ, VOUT1=3.3V, VOUT2= - 3.3V

The value of speed-up capacitor for phase compensation CFB21 :

[Conditions: Heavy load (when coil current is continuous.)]

$$f_{zfb2} = 1/2 \times \pi \times C_{FB21} \times R_{FB21} = 10kHz$$

Depending on the application, the inductance value L, and the load capacity value CL, adjustments to this value are suggested so that the value is somewhere between 1kHz to 50kHz.

[Conditions: Light load (when coil current is discontinuous.)]

Less than CFB21=0.1μF

Depending on the application, the inductance value L, and the load capacity value CL, adjustments to this value are suggested.

> Example Circuit 1 : Using voltage of Ch 1 (Step-up)

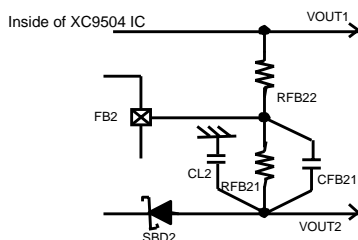

Channel 1 (Step-Up) circuits should be enable by setting EN1 to High level so that a stable voltage is provided. Inrush current to the inverter when the supply voltage VDD of the IC is 2.0 V or higher can be controlled by setting EN 1 and EN 2 to enable ("H" level) simultaneously.

> Example Circuit 1 : Using a positive regulator

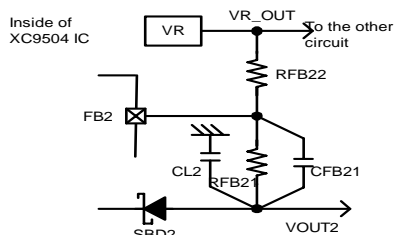

A stable positive voltage produced by a positive-voltage regulator or by other means is usable.

$$V_{OUT2} = (0.9 - V_{ROUT}) \times (R_{FB21} / R_{FB22}) + 0.9V$$

External Components

Conditions : Light load (when coil current is discontinuous.)
Channel One (Step-Up DC/DC Converter Controller)

Tr 1 :	* MOSFET XP151A12A2 (TOREX N-Channel Power MOSFET)
	Note : VGS Breakdown Voltage of this Tr. is 12V so please be careful with the power supply voltage.
SD 1 :	CRS02 (Schottky , TOSHIBA)
L1 :	10 μ H (SUMIDA, CDRH4D18C, TOKO, D412F, FOSC = 500kHz)
	15 μ H (SUMIDA, CDRH4D18C, TOKO, D412F, FOSC = 300kHz)
	22 μ H (SUMIDA, CDRH4D18C, TOKO, D412F, FOSC = 180kHz)
	Please set so that the coil current is discontinuous.
CL1 :	25V, 4.7 μ F (Ceramic)
	*NPN Tr
	2SD1628 (SANYO)
RB1 :	500 Ω Adjust in accordance with load & Tr.'s HFE
	$RB1 \leq (VIN-0.7) \times (hFE/IC-REXTBH)$
CB1 :	2200pF (Ceramic)
	$CB1 \leq (2\pi \times RB2 \times FOSC \times 0.7)$

Channel Two (Inverter DC/DC Controller)

Tr 2 :	* MOSFET XP151A12C0 (TOREX P-Channel Power MOSFET)
	Note : VGS Breakdown Voltage of this Tr. is 12V so please be careful with the power supply voltage.
SD 2 :	CRS02 (Schottky, TOSHIBA)
L2 :	10 μ H (SUMIDA, CDRH4D18C, TOKO, D412F, FOSC = 500kHz)
	15 μ H (SUMIDA, CDRH4D18C, TOKO, D412F, FOSC = 300kHz)
	22 μ H (SUMIDA, CDRH4D18C, TOKO, D412F, FOSC = 180kHz)
	Please set so that the coil current is discontinuous.
CL2 :	10V 4.7 μ F (Ceramic)
	*PNP Tr
	2SA1213 (TOSHIBA)
RB 2 :	500 Ω Adjust in accordance with load & Tr.'s HFE
	$RB2 \leq (VIN-0.7) \times (hFE/IC-REXTBL)$
CB 2 :	2200pF (Ceramic)
	$CB2 \leq (2\pi \times RB2 \times FOSC \times 0.7)$

Conditions: Heavy load (when coil current is continuous.)
Channel One (Step-Up DC/DC Converter Controller)

Tr 1 :	* MOSFET XP161A1265P (TOREX N-Channel Power MOSFET) XP161A1355P (TOREX N-Channel Power MOSFET)
	Note : VGS Breakdown Voltage of the XP161A1265P is 12V and that of the XP161A1355P is 8V so please be careful with the power supply voltage.
SD 1 :	MA2Q737 (Schottky , MATSUSHITA) CRS02, CMS02 (Schottky , TOSHIBA)
L1 :	10 μ H (SUMIDA, CDRH5D28, FOSC = 500kHz)
	15 μ H (SUMIDA, CDRH5D28, FOSC = 300kHz)
	22 μ H (SUMIDA, CDRH5D28, FOSC = 180kHz)
CL1 :	16V, 47 μ F (Tantalum)
	Increase capacity according to the equation below when the step-up voltage ratio is large and output current is high.
	$CL = (CL \text{ standard value}) \times (IOUT1 \text{ (mA)} / 300\text{mA} \times VOUT1 / VIN)$
	*NPN Tr
	2SD1628 (SANYO)
RB1 :	500 Ω Adjust in accordance with load & Tr.'s HFE
	$RB1 \leq (VIN-0.7) \times (hFE/IC-REXTBH)$
CB1 :	2200pF (Ceramic)
	$CB1 \leq (2\pi \times RB2 \times FOSC \times 0.7)$

Channel Two (Inverter DC/DC Controller)

Tr 2 :	* MOSFET XP162A12A6P (TOREX P-Channel Power MOSFET)
	Note : VGS Breakdown Voltage of the XP162A12A6P is 12V so please be careful with the power supply voltage.
SD 2 :	MA2Q737 (Schottky, MATSUSHITA) CRS02, CMS02 (Schottky , TOSHIBA)
L2 :	10 μ H (SUMIDA, CDRH5D28, FOSC = 500kHz)
	15 μ H (SUMIDA, CDRH5D28, FOSC = 300kHz)
	22 μ H (SUMIDA, CDRH5D28, FOSC = 180kHz)
CL2 :	16V, 47 μ F (Tantalum)
	Increase capacity according to the equation below when the step-up voltage ratio is large and output current is high.
	$CL = (CL \text{ standard value}) \times (IOUT2 \text{ (mA)} / 150\text{mA} \times VOUT2 / VIN)$
	*PNP Tr
	2SA1213 (TOSHIBA)
RB 2 :	500 Ω Adjust in accordance with load & Tr.'s HFE
	$RB2 \leq (VIN-0.7) \times (hFE/IC-REXTBL)$
CB 2 :	2200pF (Ceramic)
	$CB2 \leq (2\pi \times RB2 \times FOSC \times 0.7)$

Notes on how to use

Hint on application

1. Channel 1 (step-up) How to shut down the output voltage during standby mode

If the circuit configuration shown as an example of typical application circuits is used, voltage VIN will occur at VOUT 1 when the IC is in standby, the diode being bypassed. This can cause circuits connected to VOUT 1 to malfunction.

> Example of typical application circuit 1 :

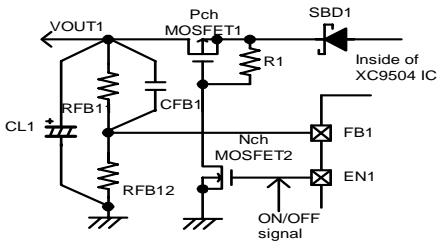

Set R1 so as to prevent leakage current of N-ch MOSFET 2.

> Example of typical application circuit 2 : Power Ready Function

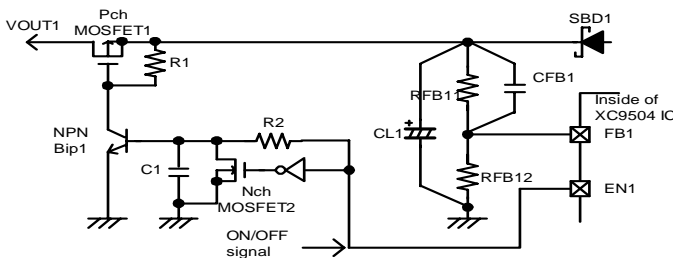

The combination of R 2, C 1, and the threshold voltage of approximately 0.7 V of NPN Bip 1 is used to produce a delay time between the circuits being enabled and P-ch MOSFET 1 being switched on. Delay time set to 20 mS ensures power to be made ready in a favorable manner, as soft start of this product is completed during the delay time.

Set Value (Example)

VOLTAGE (V)	R2 (kΩ)	C1 (μF)
2.5	430	0.15
3.3	470	0.18
5.0	430	0.33

Time to make power ready is calculated by the equation below.

$$\text{Time} = -R2 \times C1 \times \ln(1 - 0.7 / [\text{ON} / \text{OFF} \text{ Signal Voltage}])$$

Set R1 so as to prevent leakage current of NPN (Bip 1).

Nch MOSFET 2 and the inverter enables power to be turned off quickly.

2. Channel 2 (Inverting) Soft start circuit

Channel 2 (inverting) is subject to the overshoot of output voltage 2 (VOUT 2) at start-up. It is possible to control the overshoot of output voltage 2 (VOUT 2), as shown by circuit example 1 in "Output Voltage Settings for Channel 2" in "Function Settings." In this circuit configuration, EN 1 and EN 2 are enabled (set to "H" level) simultaneously. This lets output voltage 1 (VOUT 1) of channel 1 increase gently as soft start, thereby controlling the overshoot.

> Example of typical application circuit : Improved Soft start

This example is effective when EN 1 and EN 2 are enabled with different timings under light load condition (the coil current being discontinuous).

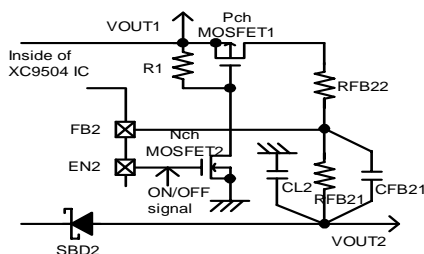

Time to make soft start time is calculated by the equation below.

$$\text{Time}_{SS2} = -R_{FB21} \times C_{CFB21} / \ln \left[1 - \frac{(0.9 - V_{OUT2}) \times R_{FB22}}{(V_{OUT1} - 0.9) \times R_{FB21}} \right]$$

Example)

When VOUT1 = 15V and VOUT2 = - 7.5V,

RFB21 = 59.6kΩ, RFB22 = 100kΩ by the equation below.

$$V_{OUT2} = (0.9 - V_{OUT1}) \times (R_{FB21} / R_{FB22}) + 0.9$$

When the light load, CFB21=0.1μF or lower value can be used.

Therefore, when CFB21=0.027μF,

Time_{ss2} = 5.0mS and VOUT2 = 95% of setting value

3. Channel 2 (Inverting) Withstand voltage of transistor

The voltage applied between the drain and source is the sum of VIN and VOUT 2.

Select a transistor with an absolute VDSS rating that is suitable for your operating conditions.

Example: The voltage applied across VDS of a transistor will be 20.0V if VIN = 5.0 V and VOUT 2 = -15.0 V.

Under this condition, a transistor with VDSS higher than 20.0V should be selected. (Use a transistor with VDSS that is 1.5 times the applied voltage or more, as a standard.)

■ Test Circuits

Circuit 1

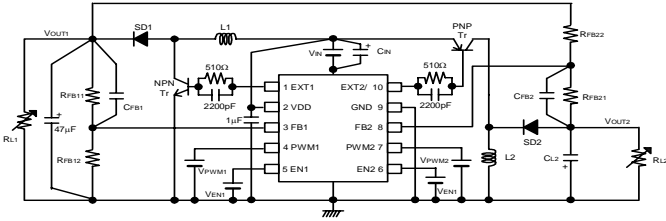

Circuit 5

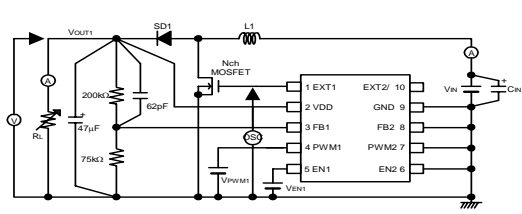

Circuit 2

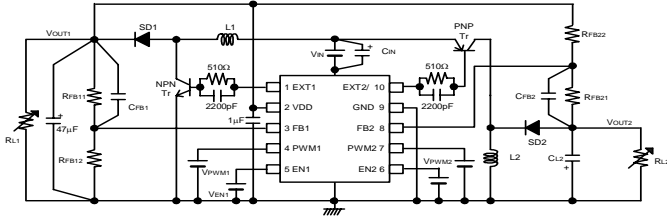

Circuit 6

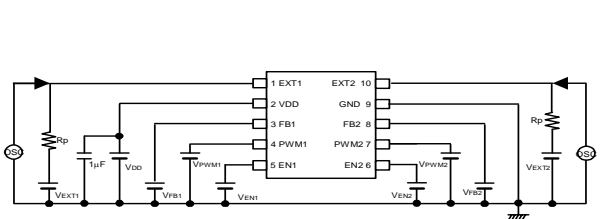

Circuit 3

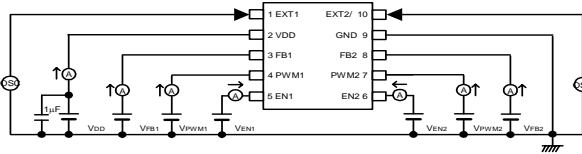

Circuit 7

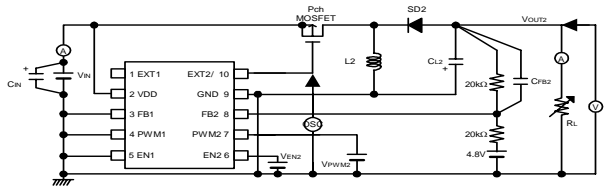

Circuit 4

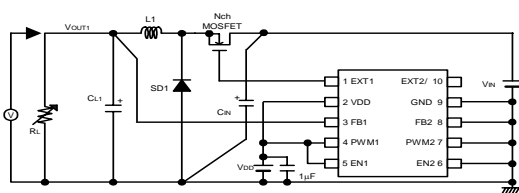

External Components of the Test Circuits

Circuits 1, Circuits 2

L1, L2: 22 μ H (SUMIDA CDRH5D28) : XC9504B092A
 15 μ H (SUMIDA CDRH5D28) : XC9504B093A
 10 μ H (SUMIDA CDRH5D28) : XC9504B095A
 SD1, SD2: CRS02 (Schottky, TOSHIBA)
 EC10QS06 (Schottky, NIHON INTER)
 CL1, CL2: 16MCE476MD2 (Tantalum, NIHON CHEMICON)
 35MCE335MB x 3 (Tantalum, NIHON CHEMICON)
 CIN : 16MCE476MD2
 NPN Tr 1 : 2SD1628 (SANYO)
 PNP Tr 2 : 2SA1213 (TOSHIBA)
 RFB : Please use by the conditions as below.
 $RFB11 + RFB12 \leq 1M\Omega$
 $RFB21 + RFB22 \leq 1M\Omega$
 $RFB11 / RFB12 = (\text{Setting Output Voltage} / 0.9) - 1$
 $VOUT2 = (0.9 - VOUT1) / (RFB21 / RFB22) + 0.9$
 CFB : $f_{zfb} = 1 / (2 \times \pi \times CFB1 \times RFB11) = 1\text{kHz to } 50\text{kHz (12kHz usual)}$
 $f_{zfb} = 1 / (2 \times \pi \times CFB2 \times RFB21) = 1\text{kHz to } 50\text{kHz (12kHz usual)}$

Circuits 4

L1 : 22 μ H (SUMIDA CDRH5D28)
 SD 1 : MA2Q737 (Schottky, MATSUSHITA)
 CL 1 : 16MCE476MD2 (Tantalum, NIHONCHEMICON)
 CIN : 16MCE476MD2 (Tantalum, NIHONCHEMICON)
 Nch MOSFET : XP161A1355P (TOREX)

Circuits 5

L1 : 22 μ H (SUMIDA CDRH5D28) : XC9504B092A
 15 μ H (SUMIDA CDRH5D28) : XC9504B093A
 10 μ H (SUMIDA CDRH5D28) : XC9504B095A
 SD 1 : MA2Q737 (Schottky, MATSUSHITA)
 CL 1 : 16MCE476MD2 (Tantalum, NIHONCHEMICON)
 CIN : 16MCE476MD2 (Tantalum, NIHONCHEMICON)
 Nch MOSFET : XP161A1355P (TOREX)

Circuits 7

L2 : 22 μ H (SUMIDA CDRH5D28) : XC9504B092A
 15 μ H (SUMIDA CDRH5D28) : XC9504B093A
 10 μ H (SUMIDA CDRH5D28) : XC9504B095A
 SD 2 : MA2Q737 (Schottky, MATSUSHITA)
 CL 2 : 16MCE476MD2 (Tantalum, NIHONCHEMICON)
 CIN : 16MCE476MD2 (Tantalum, NIHONCHEMICON)
 Pch MOSFET : XP162A12A6P (TOREX)

■ Note on Use

1. PWM/PFM Automatic Switching

If PWM/PFM automatic switching control is selected and the step-up ratio is low (e.g., from 4.5 V to 5.0 V), the control mode remains in PFM setting over the whole load range, since the duty ratio under continuous-duty condition is smaller than the PFM duty ratio of the XC9504 series. The output voltage's ripple voltage becomes substantially high under heavy load conditions, with the XC9504 series appearing to be producing an abnormal oscillation. If this operation becomes a concern, set pins PWM to High to set the control mode to PWM setting. For use under the above-mentioned condition, measured data of PWM/PFM automatic switching control shown on the data sheets are available up to $I_{OUT} = 100 \text{ mA}$.

2. Ratings

Use the XC9504 series and peripheral components within the limits of their ratings.

■ Typical Performance Characteristics

< 1 ch. Step-Up DC/DC Controller >

(1) Output Voltage vs. Output Current

(Ceramic Capacitor and Compact Inductor use)

FOSC=180kHz, VOUT1= 10.0V

L1=22uH(LLB2520), CL1=10uF(ceramic)
SD1:CRS02, Tr1:XP151A12A2MR

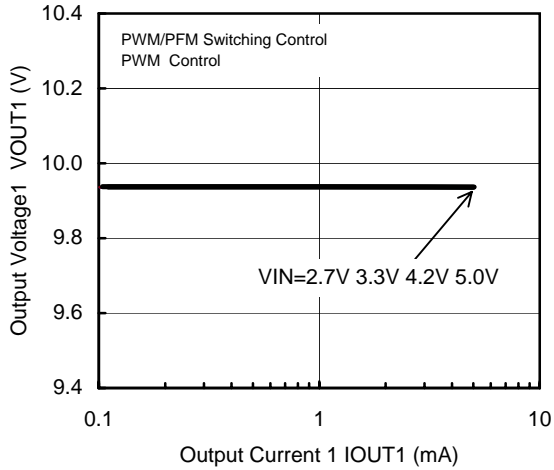

FOSC=180kHz, VOUT1= 15.0V

L1=22uH(LLB2520), CL1=10uF(ceramic)
SD1:CRS02, Tr1:XP151A12A2MR

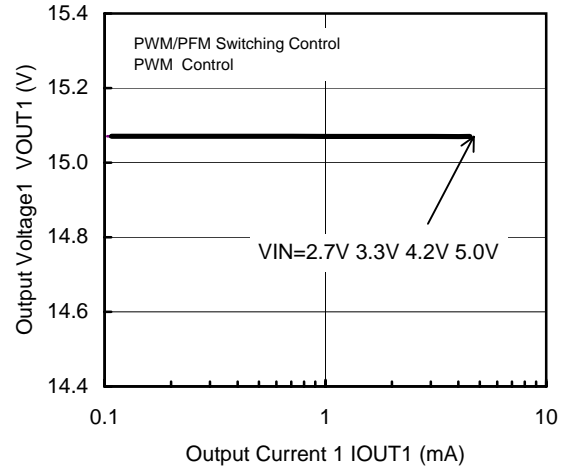

FOSC=180kHz, VOUT1= 20.0V

L1=22uH(LLB2520), CL1=4.4uF(ceramic)
SD1:CRS02, Tr1:XP151A11B0MR

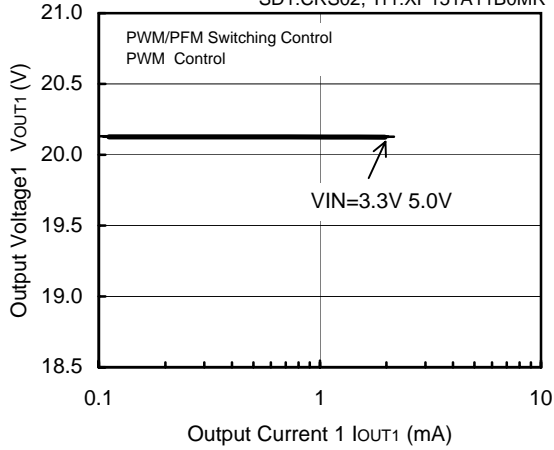

FOSC=180kHz, VOUT1= 30.0V

L1=22uH(LLB2520), CL1=2uF(ceramic)
SD1:CRS02, Tr1:2SK2857

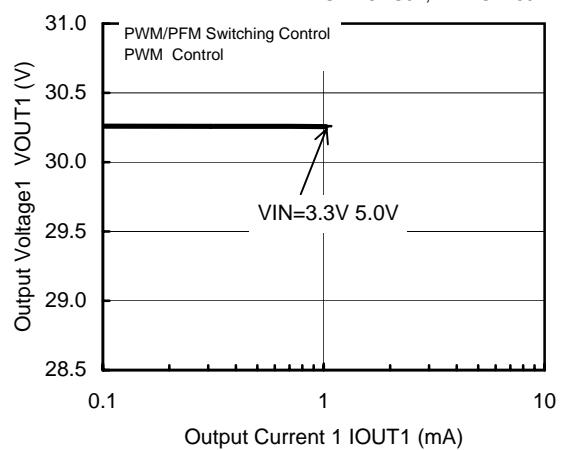

< 1 ch. Step-Up DC/DC Controller >

(1) Output Voltage vs. Output Current (Continued)

(Ceramic Capacitor use)

FOSC=180kHz, VOUT1= 10.0V

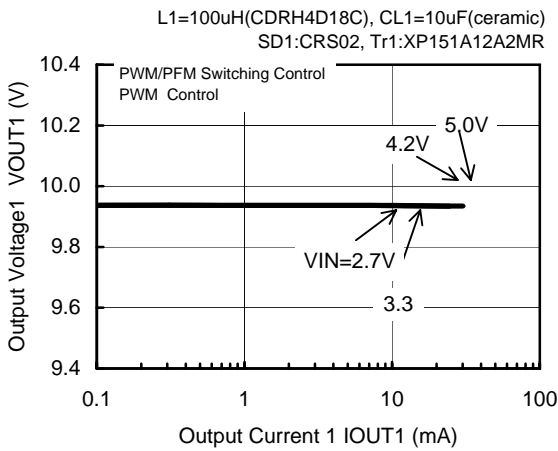

FOSC=180kHz, VOUT1= 15.0V

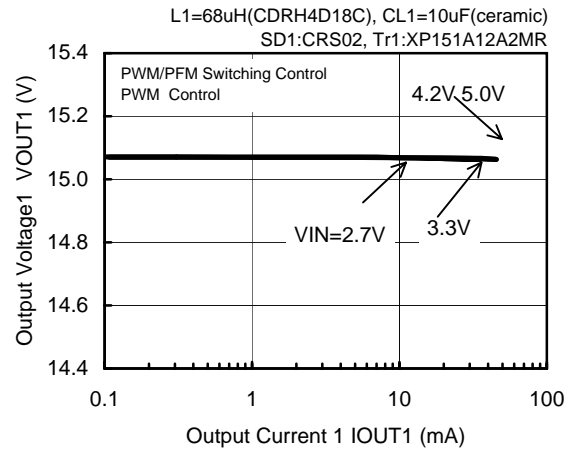

FOSC=180kHz, VOUT1= 10.0V

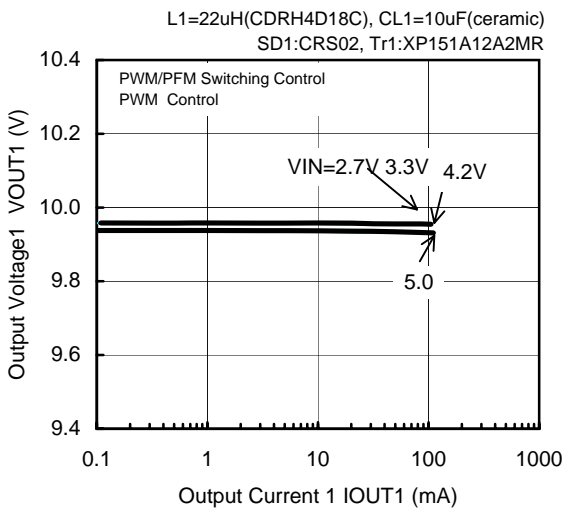

FOSC=180kHz, VOUT1= 15.0V

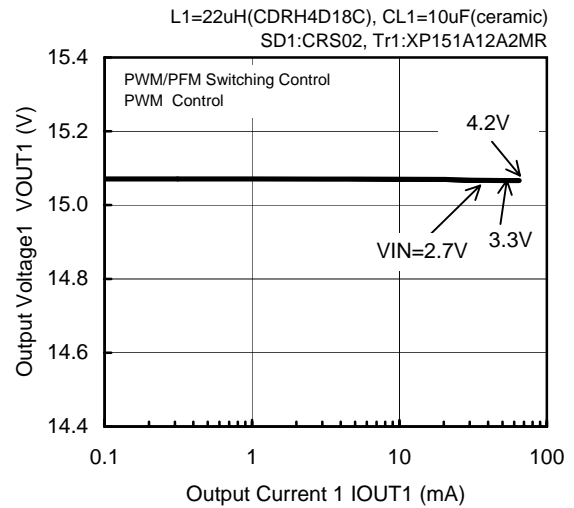

FOSC=180kHz, VOUT1= 20.0V

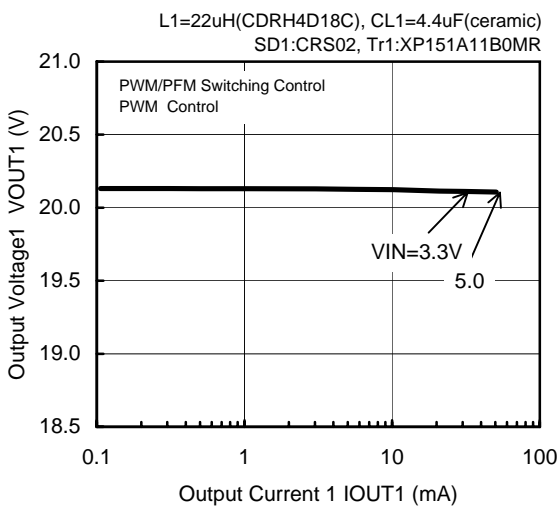

FOSC=180kHz, VOUT1= 30.0V

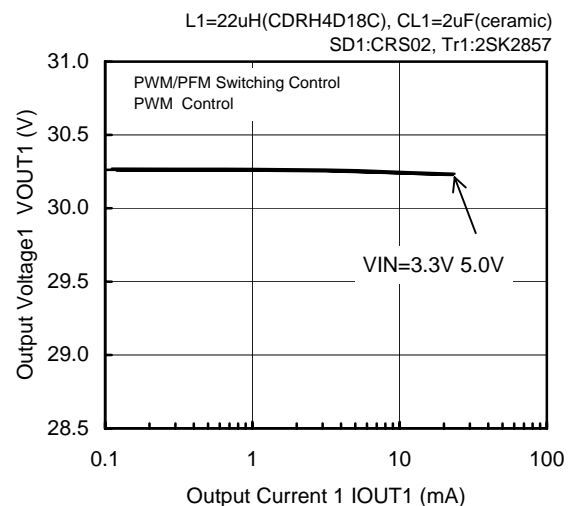

< 1 ch. Step-Up DC/DC Controller >

(1) Output Voltage vs. Output Current (Continued)

(Tantalum Capacitor Use)

FOSC=180kHz, VOUT1= 1.5V

L1=22uH(CDRH5D28), CL1=94uF(Tantalum)
SD1:CMS02, Tr1:XP161A1355P

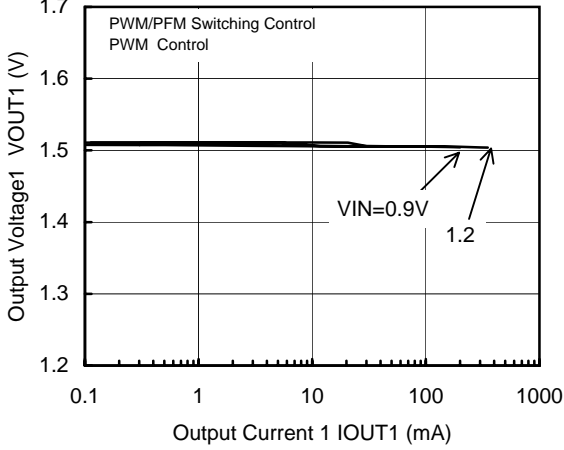

FOSC=180kHz, VOUT1= 2.5V

L1=22uH(CDRH5D28), CL1=94uF(Tantalum)
SD1:CMS02, Tr1:XP161A1355P

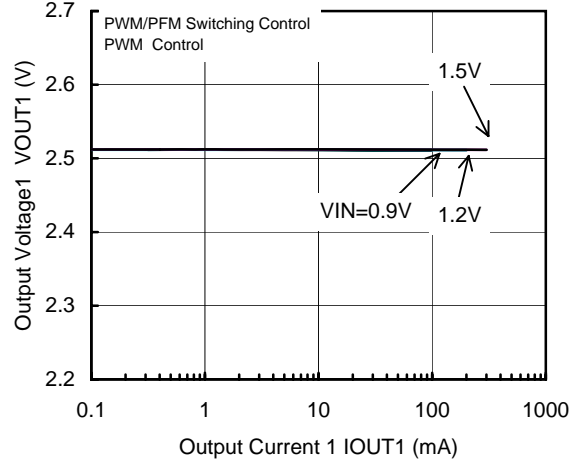

FOSC=180kHz, VOUT1= 3.3V

L1=22uH(CDRH5D28), CL1=94uF(Tantalum)
SD1:CMS02, Tr1:XP161A1355P

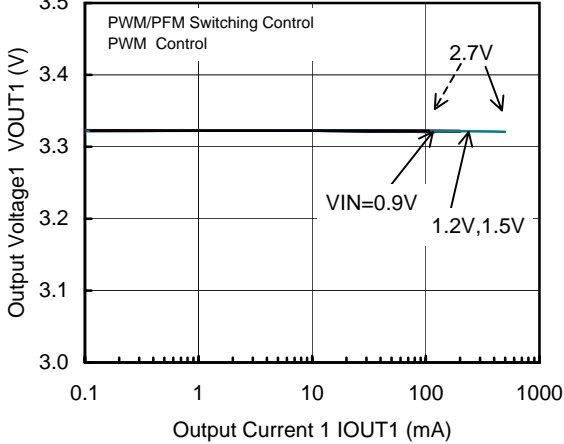

FOSC=180kHz, VOUT1= 5.0V

L1=22uH(CDRH5D28), CL1=94uF(Tantalum)
SD1:CMS02, Tr1:XP161A1355P

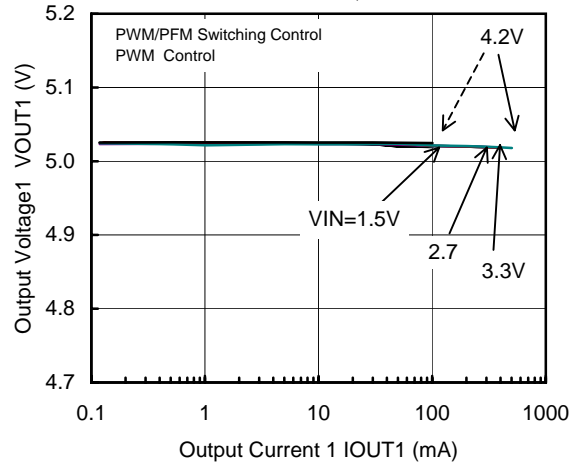

FOSC=180kHz, VOUT1= 8.0V

L1=22uH(CDRH5D28), CL1=94uF(Tantalum)
SD1:CMS02, Tr1:XP161A1265P

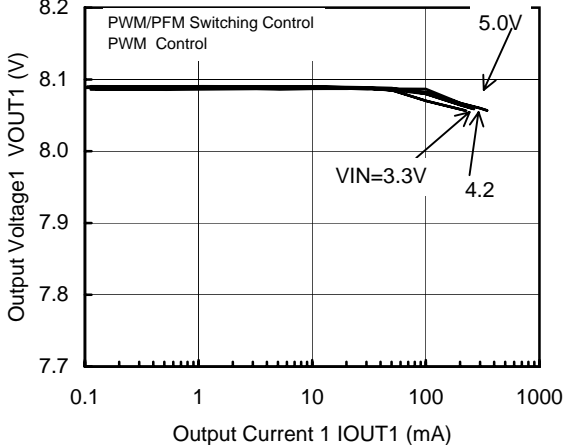

* Dotted Arrow Head ----> PWM/PFM Switching Control

< 1 ch. Step-Up DC/DC Controller >

(1) Output Voltage vs. Output Current (Continued)

(Tantalum Capacitor Use)

FOSC=300kHz, VOUT1= 2.5V

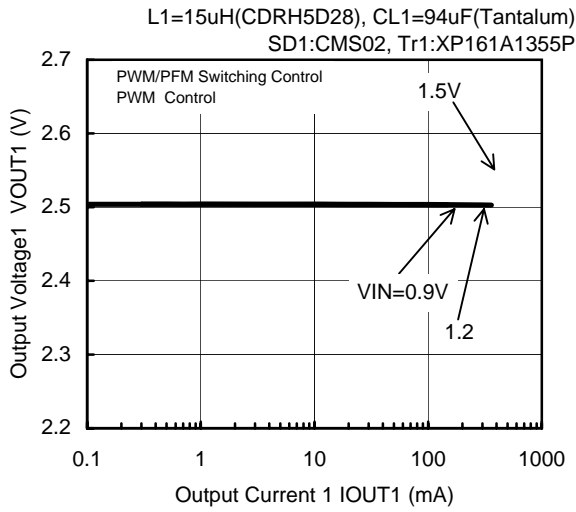

FOSC=300kHz, VOUT1= 3.3V

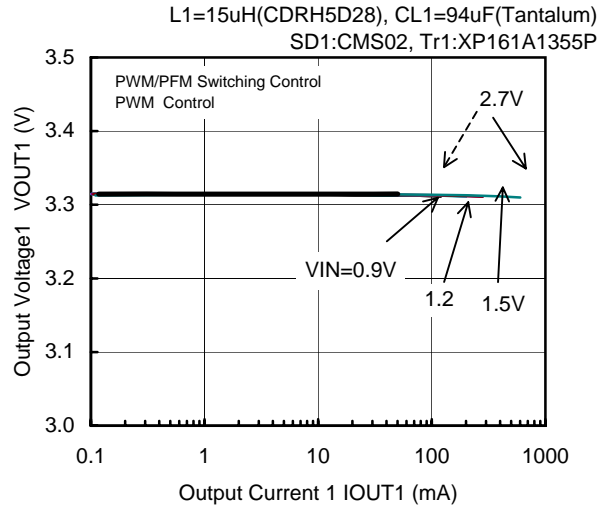

FOSC=300kHz, VOUT1= 5.0V

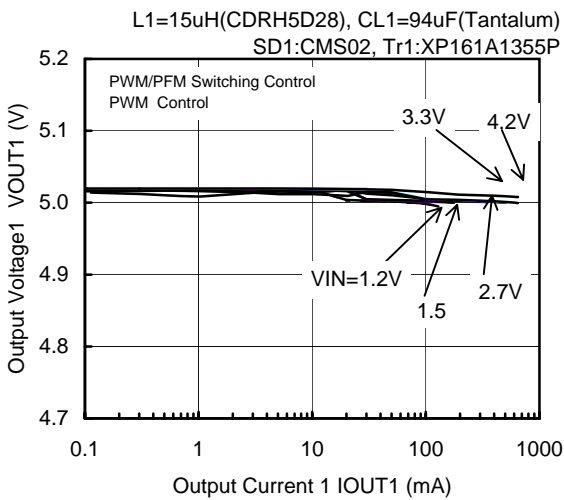

FOSC=500kHz, VOUT1= 2.5V

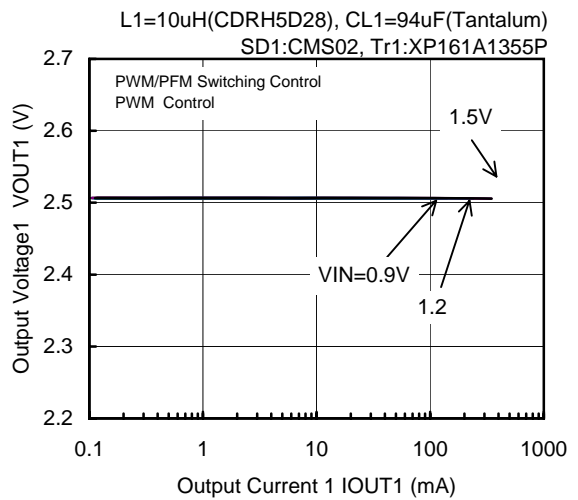

FOSC=500kHz, VOUT1= 3.3V

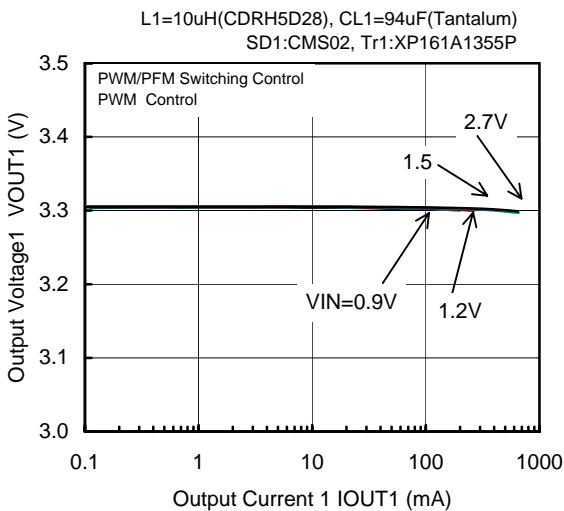

FOSC=500kHz, VOUT1= 5.0V

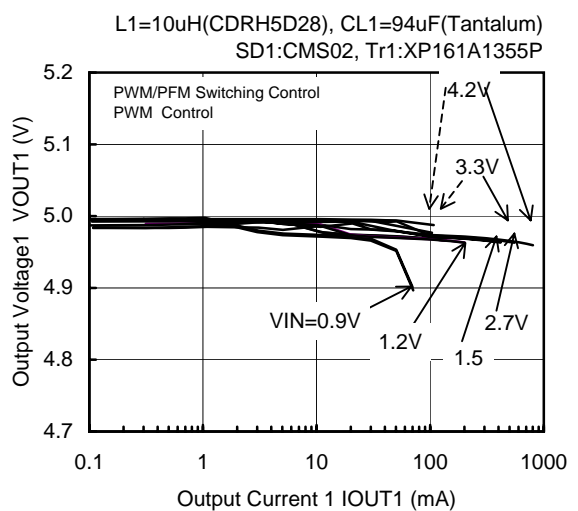

* Dotted Arrow Head -----> PWM/PFM Switching Control

< 1 ch. Step-Up DC/DC Controller >

(2) Efficiency vs. Output Current

(Ceramic Capacitor and Compact Inductor Use)

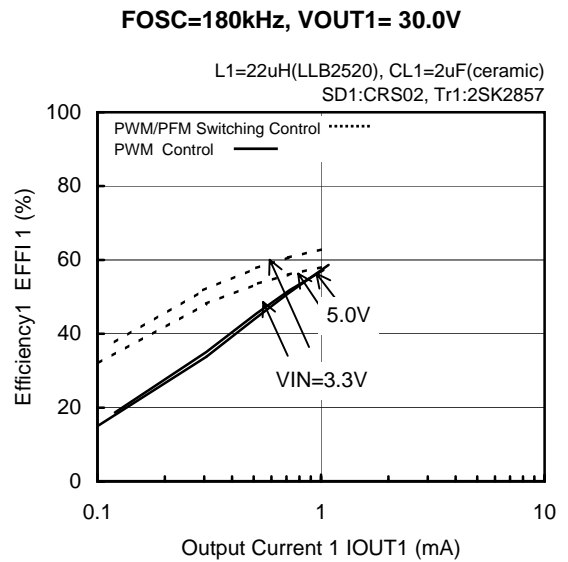
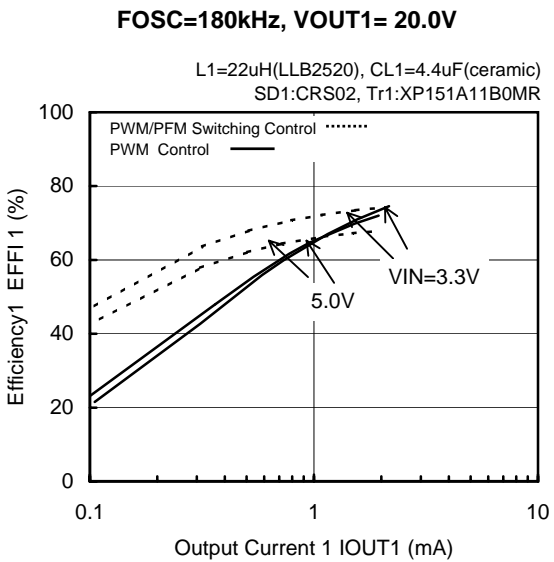
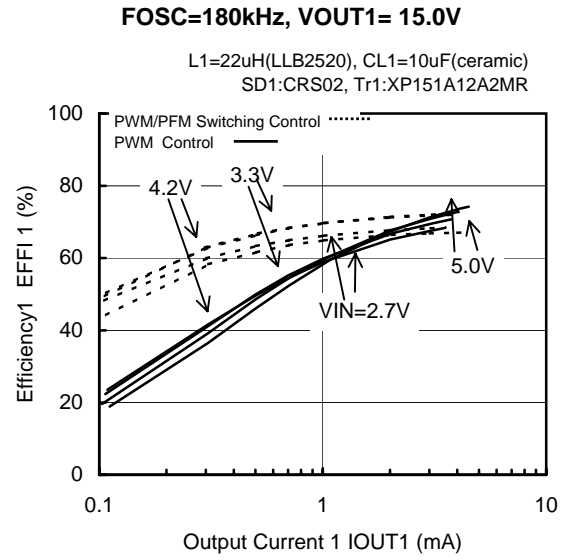
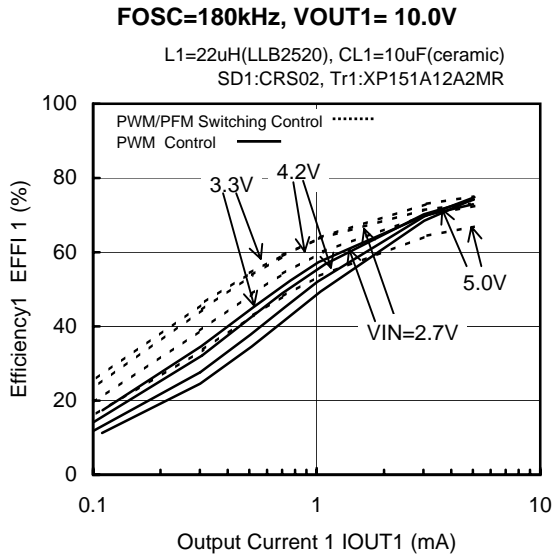

< 1 ch. Step-Up DC/DC Controller >

(2) Efficiency vs. Output Current (Continued)

(Ceramic Capacitor Use)

FOSC=180kHz, VOUT1= 10.0V

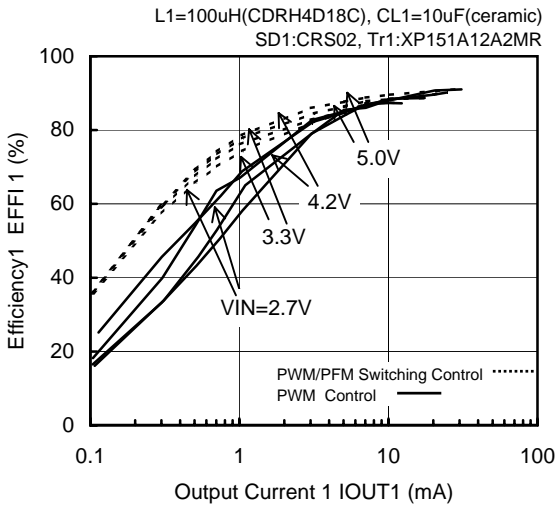

FOSC=180kHz, VOUT1= 15.0V

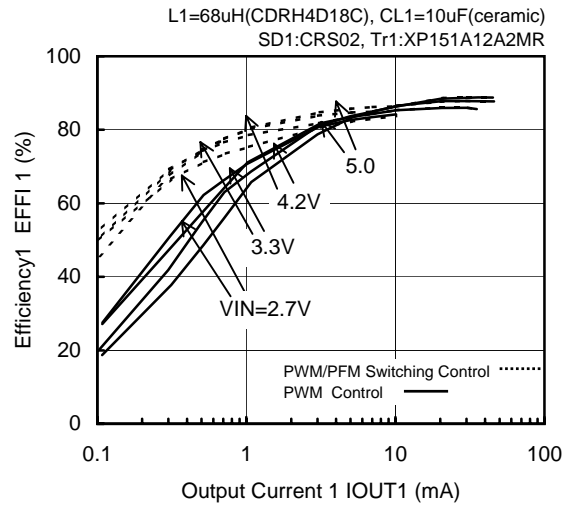

FOSC=180kHz, VOUT1= 10.0V

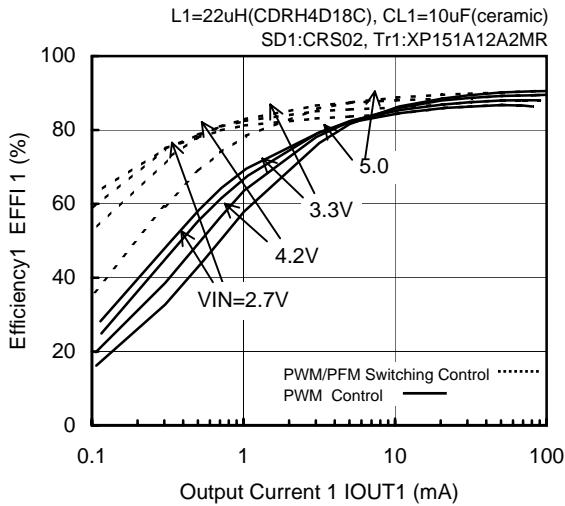

FOSC=180kHz, VOUT1= 15.0V

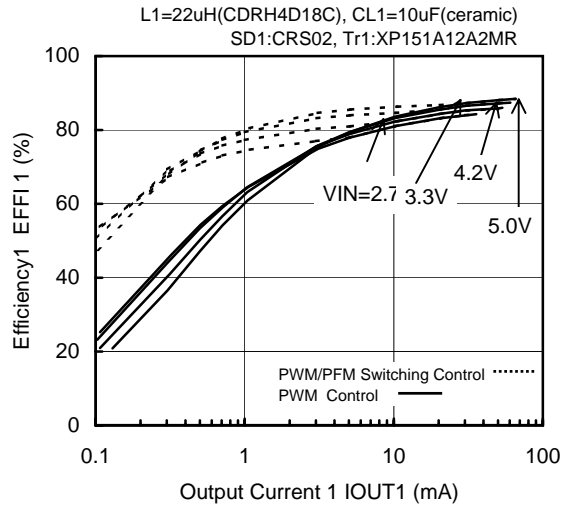

FOSC=180kHz, VOUT1= 20.0V

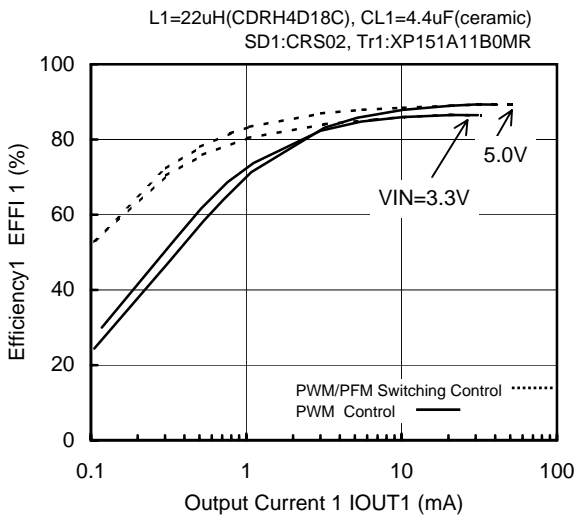

FOSC=180kHz, VOUT1= 30.0V

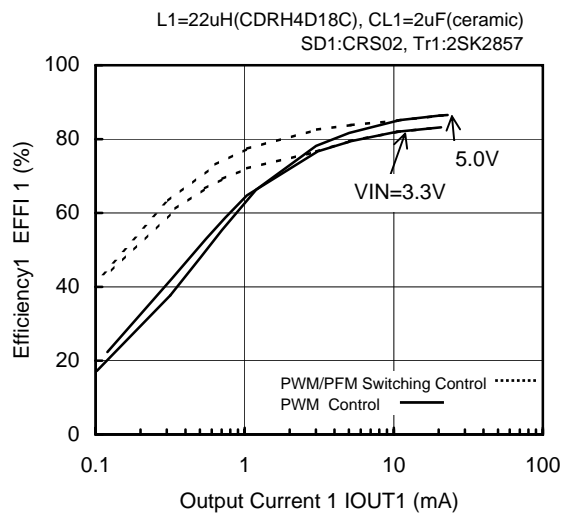

< 1 ch. Step-Up DC/DC Controller >

(2) Efficiency vs. Output Current (Continued)

(Tantalum Capacitor Use)

FOSC=180kHz, VOUT1= 1.5V

L1=22uH(CDRH5D28), CL1=94uF(Tantalum)
SD1:CMS02, Tr1:XP161A1355P

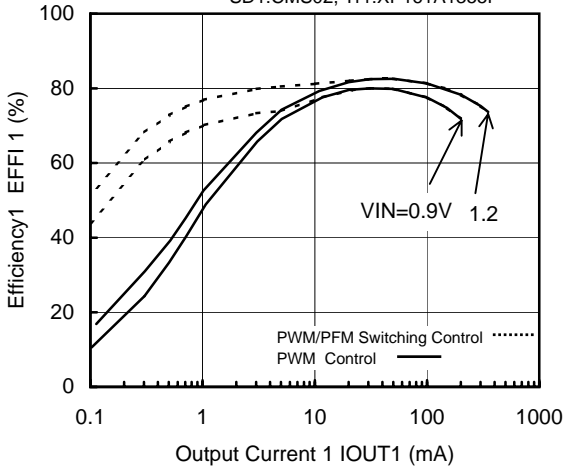

FOSC=180kHz, VOUT1= 2.5V

L1=22uH(CDRH5D28), CL1=94uF(Tantalum)
SD1:CMS02, Tr1:XP161A1355P

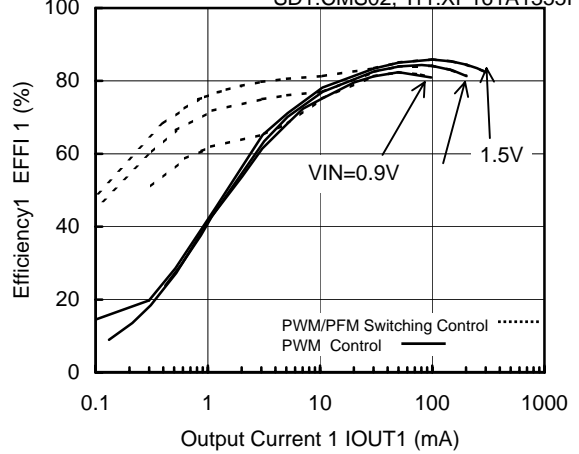

FOSC=180kHz, VOUT1= 3.3V

L1=22uH(CDRH5D28), CL1=94uF(Tantalum)
SD1:CMS02, Tr1:XP161A1355P

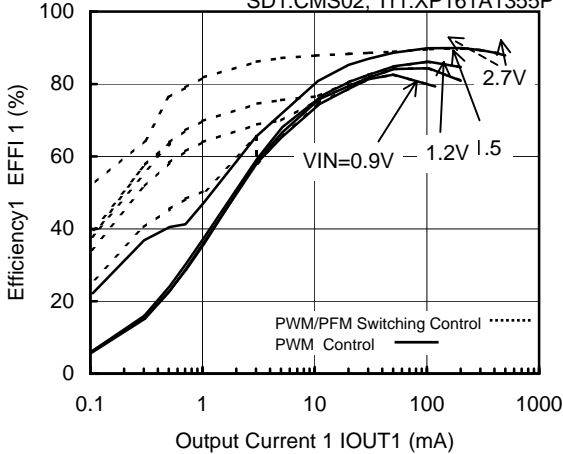

FOSC=180kHz, VOUT1= 5.0V

L1=22uH(CDRH5D28), CL1=94uF(Tantalum)
SD1:CMS02, Tr1:XP161A1355P

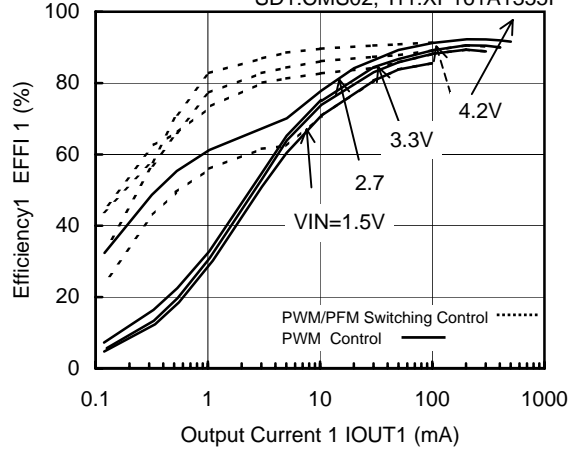

FOSC=180kHz, VOUT1= 8.0V

L1=22uH(CDRH5D28), CL1=94uF(Tantalum)
SD1:CMS02, Tr1:XP161A1265P

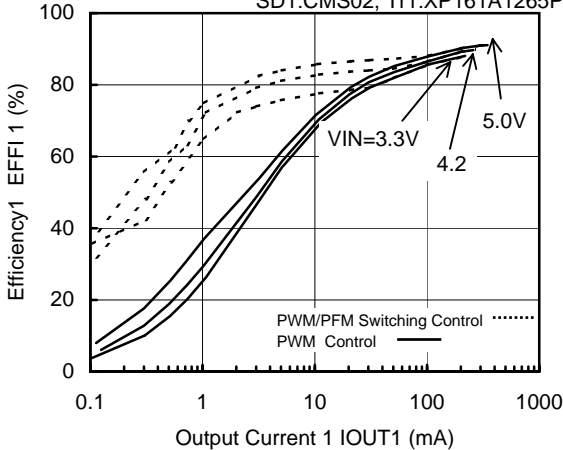

* Dotted Arrow Head -----> PWM/PFM Switching Control

< 1 ch. Step-Up DC/DC Controller >

(2) Efficiency vs. Output Current (Continued)

(Tantalum Capacitor Use)

FOSC=300kHz, VOUT1= 2.5V

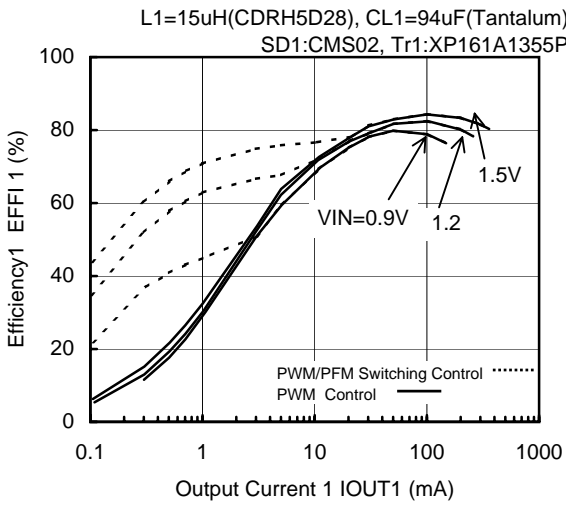

FOSC=300kHz, VOUT1= 3.3V

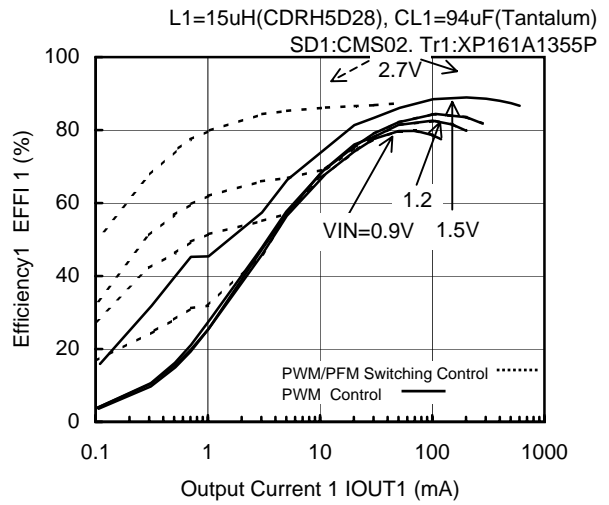

FOSC=300kHz, VOUT1= 5.0V

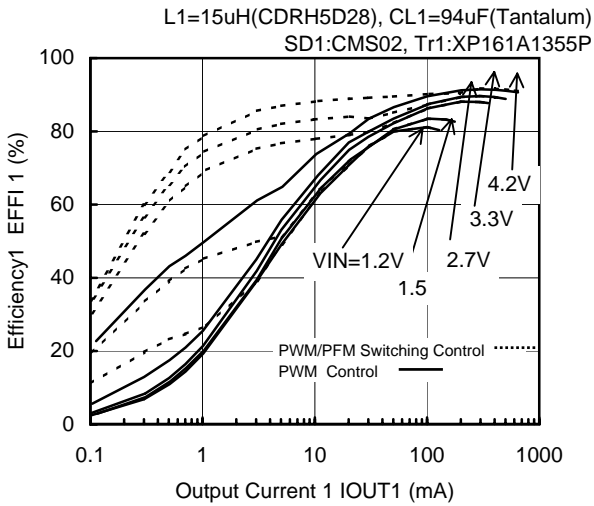

FOSC=500kHz, VOUT1= 2.5V

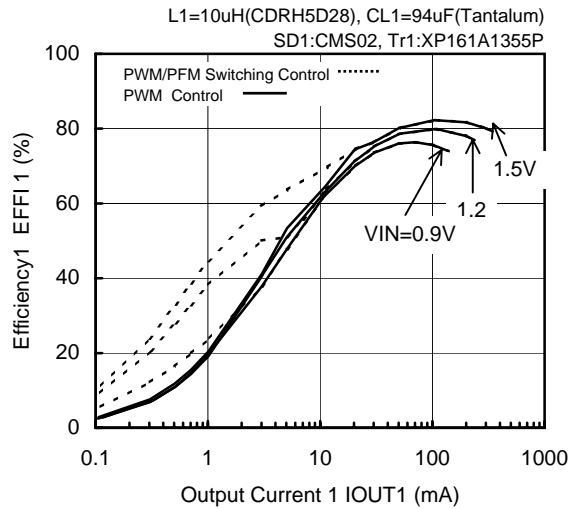

FOSC=500kHz, VOUT1= 3.3V

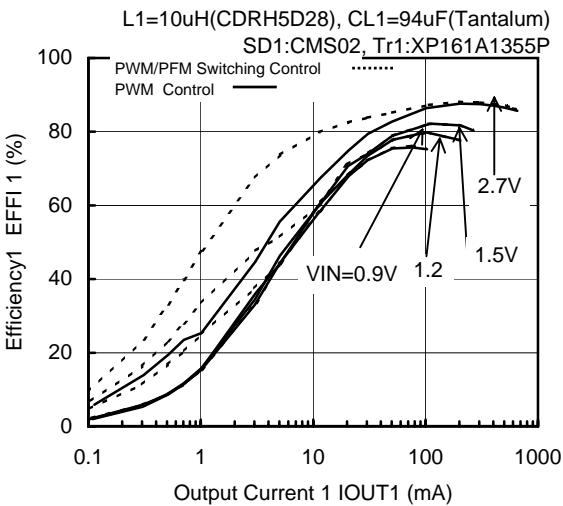

FOSC=500kHz, VOUT1= 5.0V

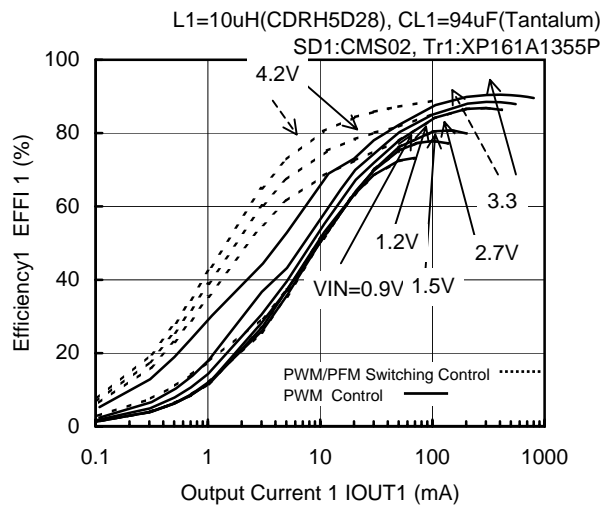

* Dotted Arrow Head -----> PWM/PFM Switching Control

< 1 ch. Step-Up DC/DC Controller >

(3) Ripple Voltage vs. Output Current

(Ceramic Capacitor and Compact Inductor Use)

FOSC=180kHz, VOUT1= 10.0V

L1=22uH(LLB2520), CL1=10uF(ceramic)
SD1:CRS02, Tr1:XP151A12A2MR

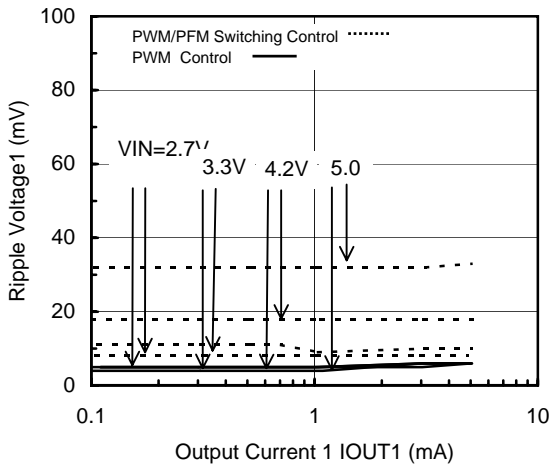

FOSC=180kHz, VOUT1= 15.0V

L1=22uH(LLB2520), CL1=10uF(ceramic)
SD1:CRS02, Tr1:XP151A12A2MR

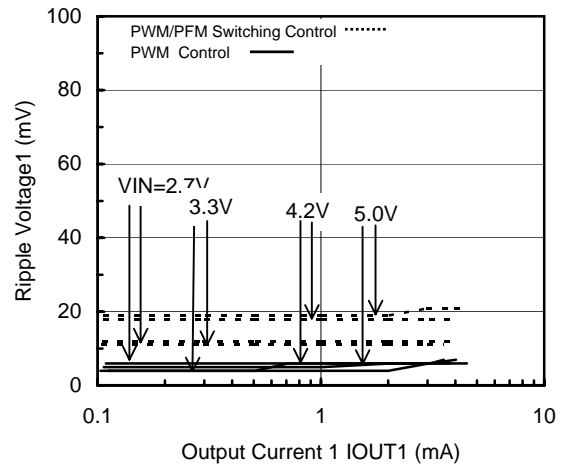

FOSC=180kHz, VOUT1= 20.0V

L1=22uH(LLB2520), CL1=4.4uF(ceramic)
SD1:CRS02, Tr1:XP151A11B0MR

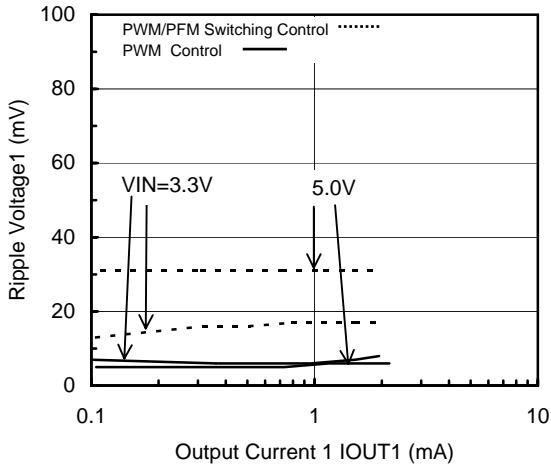

FOSC=180kHz, VOUT1= 30.0V

L1=22uH(LLB2520), CL1=2uF(ceramic)
SD1:CRS02, Tr1:2SK2857

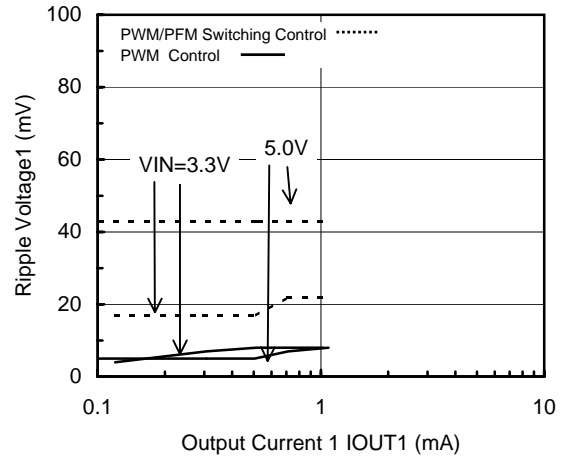

< 1 ch. Step-Up DC/DC Controller >

(3) Ripple Voltage vs. Output Current (Continued)

(Ceramic Capacitor Use)

FOSC=180kHz, VOUT1= 10.0V

L1=100uH(CDRH4D18C), CL1=10uF(ceramic)
SD1:CRS02, Tr1:XP151A12A2MR

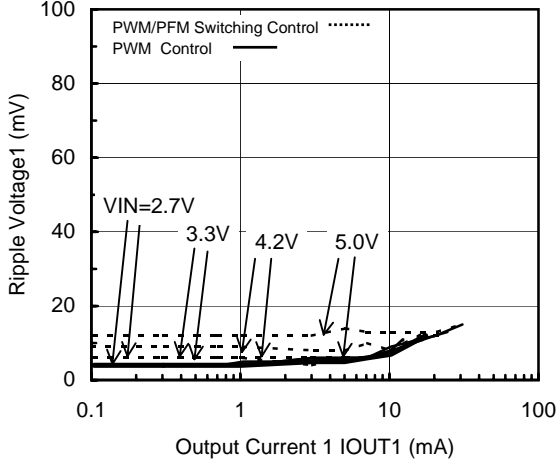

FOSC=180kHz, VOUT1= 15.0V

L1=68uH(CDRH4D18C), CL1=10uF(ceramic)
SD1:CRS02, Tr1:XP151A12A2MR

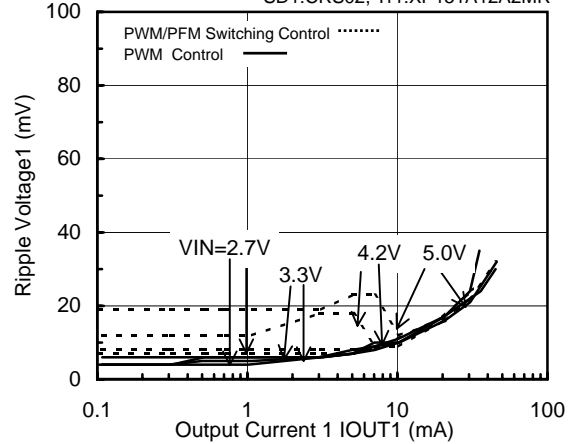

FOSC=180kHz, VOUT1= 10.0V

L1=22uH(CDRH4D18C), CL1=10uF(ceramic)
SD1:CRS02, Tr1:XP151A12A2MR

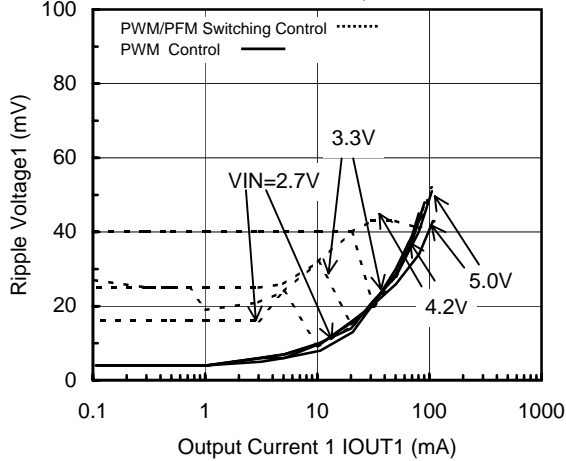

FOSC=180kHz, VOUT1= 15.0V

L2=22uH(CDRH4D18C), CL2=10uF(ceramic)
SD2:CRS02, Tr2:XP151A12A2MR

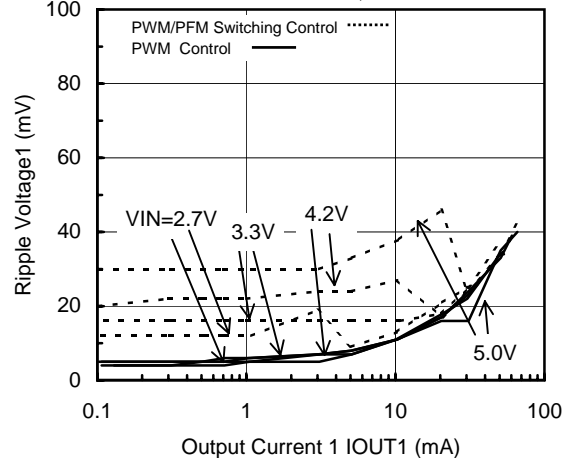

FOSC=180kHz, VOUT1= 20.0V

L1=22uH(CDRH4D18C), CL1=4.4uF(ceramic)
SD1:CRS02, Tr1:XP151A11B0MR

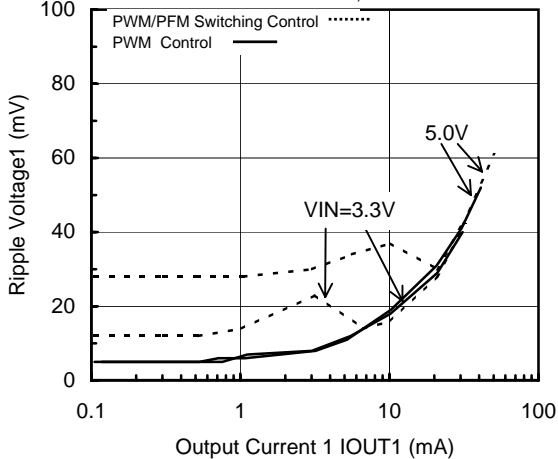

FOSC=180kHz, VOUT1= 30.0V

L1=22uH(CDRH4D18C), CL1=2uF(ceramic)
SD1:CRS02, Tr1:2SK2857

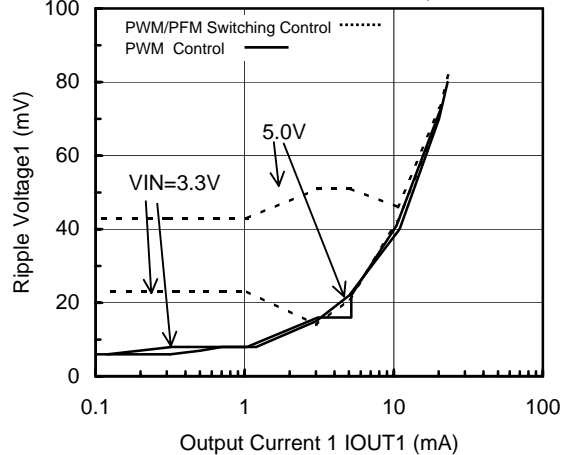

< 1 ch. Step-Up DC/DC Controller >

(3) Ripple Voltage vs. Output Current (Continued)

(Tantalum Capacitor Use)

FOSC=180kHz, VOUT1= 1.5V

L1=22uH(CDRH5D28), CL1=94uF(Tantalum)
SD1:CMS02, Tr1:XP161A1355P

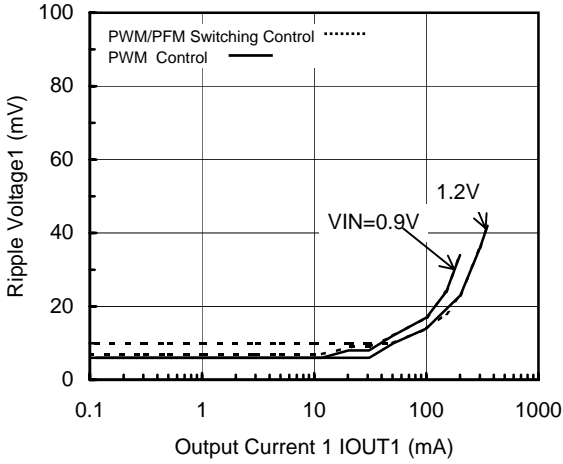

FOSC=180kHz, VOUT1= 2.5V

L1=22uH(CDRH5D28), CL1=94uF(Tantalum)
SD1:CMS02, Tr1:XP161A1355P

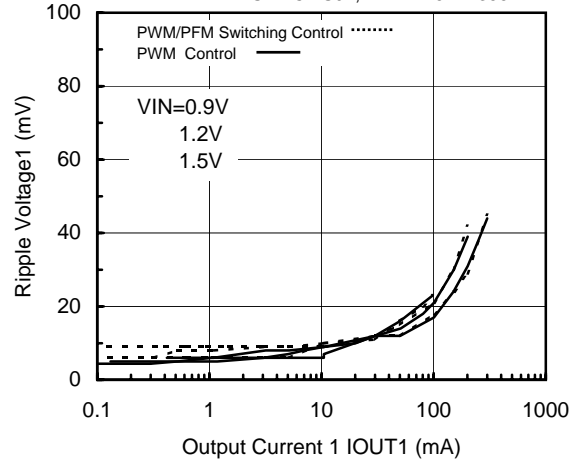

FOSC=180kHz, VOUT1= 3.3V

L1=22uH(CDRH5D28), CL1=94uF(Tantalum)
SD1:CMS02, Tr1:XP161A1355P

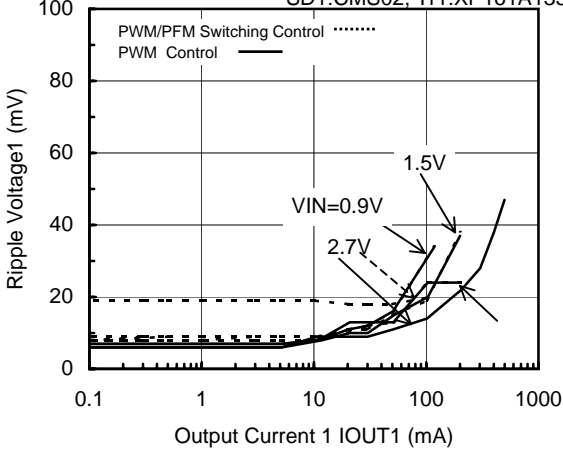

FOSC=180kHz, VOUT1= 5.0V

L1=22uH(CDRH5D28), CL1=94uF(Tantalum)
SD1:CMS02, Tr1:XP161A1355P

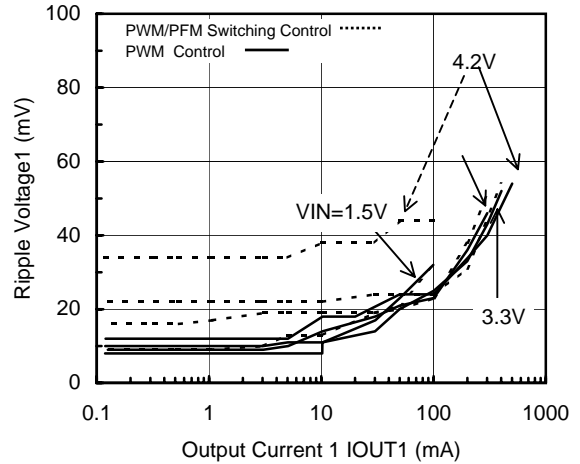

FOSC=180kHz, VOUT1= 8.0V

L1=22uH(CDRH5D28), CL1=94uF(Tantalum)
SD1:CMS02, Tr1:XP161A1265P

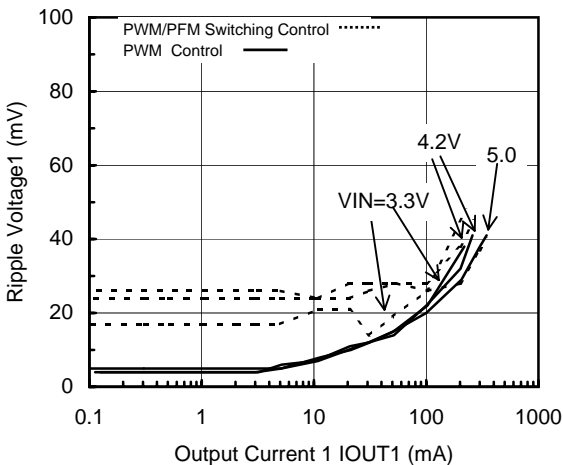

* Dotted Arrow Head ----> PWM/PFM Switching Control

< 1 ch. Step-Up DC/DC Controller >

(3) Ripple Voltage vs. Output Current (Continued)

(Tantalum Capacitor Use)

FOSC=300kHz, VOUT1= 2.5V

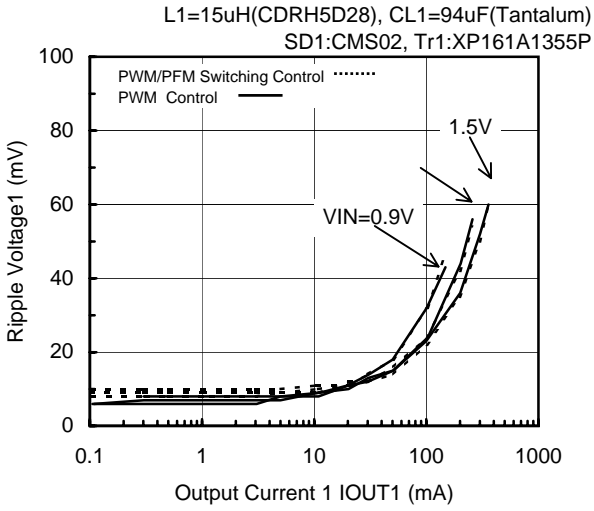

FOSC=300kHz, VOUT1= 3.3V

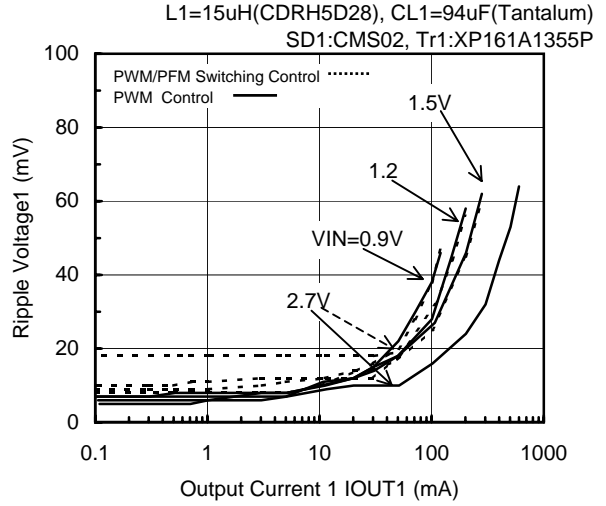

FOSC=300kHz, VOUT1= 5.0V

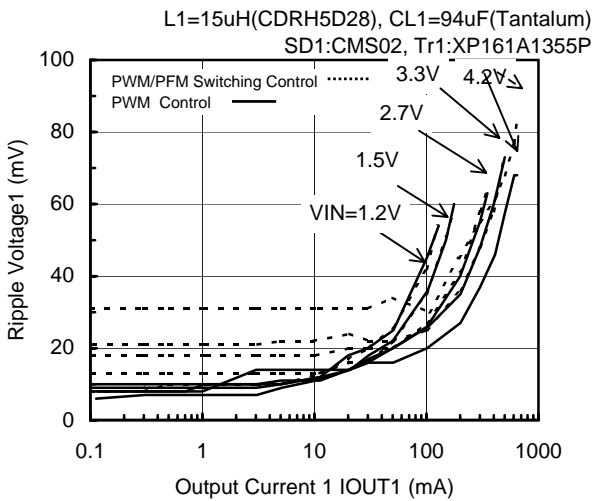

FOSC=500kHz, VOUT1= 2.5V

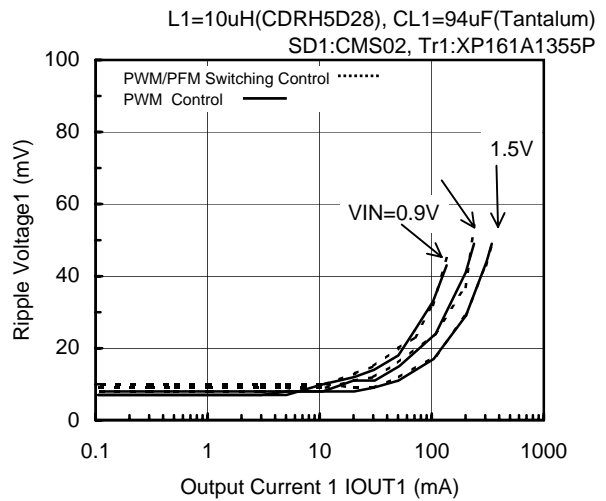

FOSC=500kHz, VOUT1= 3.3V

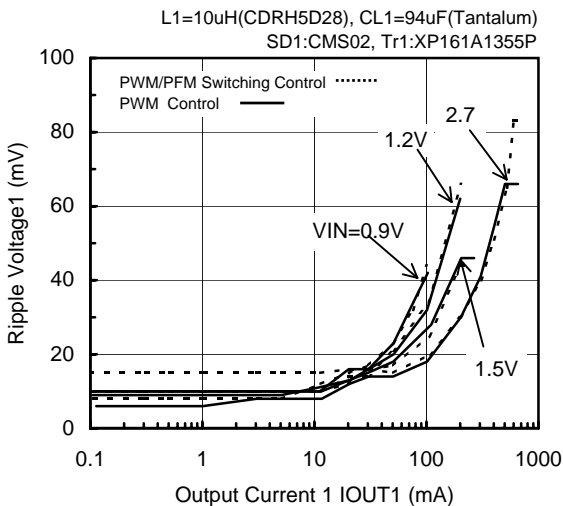

FOSC=500kHz, VOUT1= 5.0V

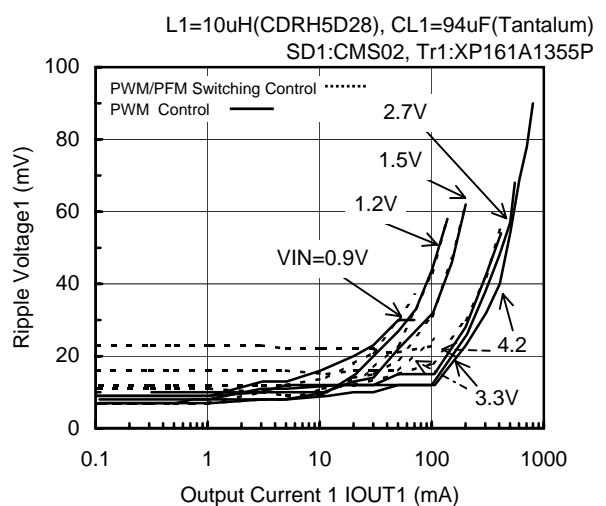

* Dotted Arrow Head -----> PWM/PFM Switching Control

■ Typical Performance Characteristics (Continued)

< 2 ch. Inverting DC/DC Controller >

(4) Output Voltage vs. Output Current

(Ceramic Capacitor and Compact Inductor use)

FOSC=180kHz, VOUT2= -7.5V

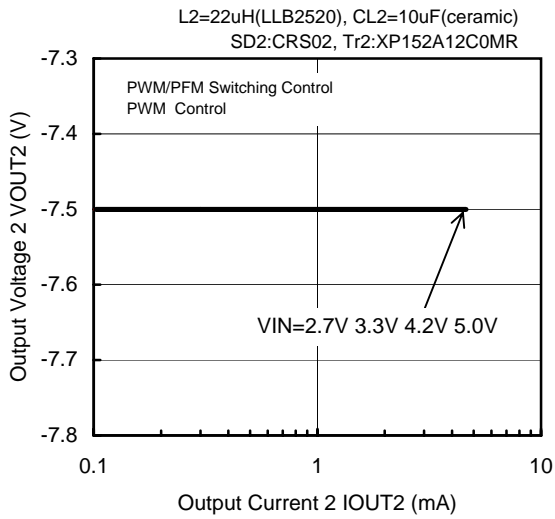

FOSC=180kHz, VOUT2= -10.0V

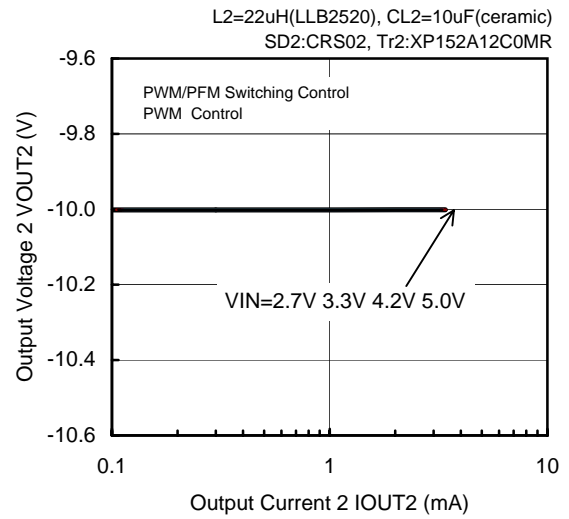

FOSC=300kHz, VOUT2= -7.5V

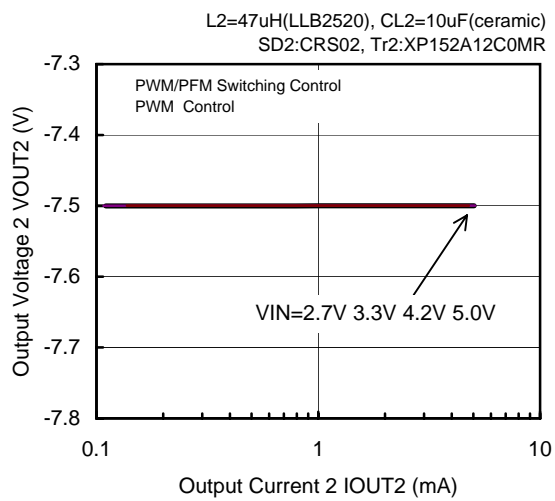

< 2 ch. Inverting DC/DC Controller >

(4) Output Voltage vs. Output Current (Continued)

(Ceramic Capacitor use)

FOSC=180kHz, VOUT2= -7.5V

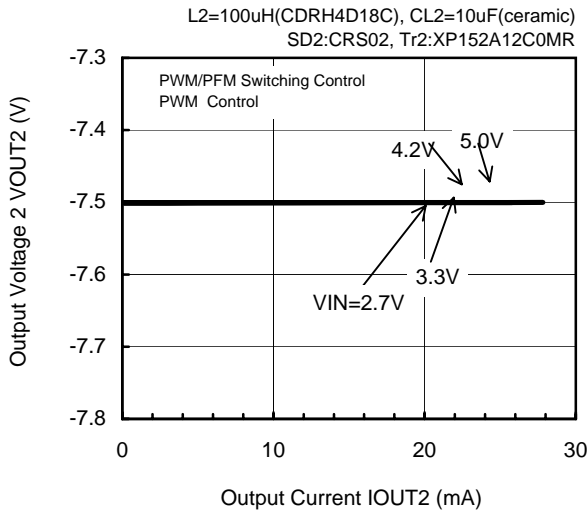

FOSC=180kHz, VOUT2= -10.0V

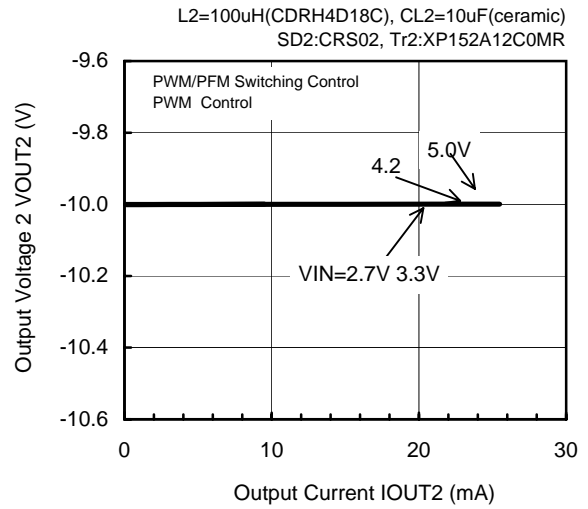

FOSC=180kHz, VOUT2= -7.5V

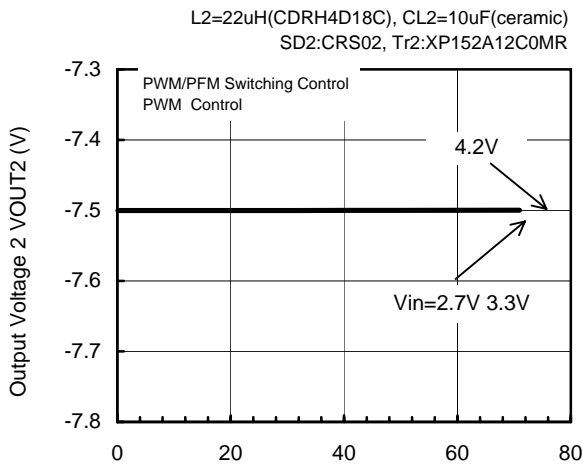

FOSC=180kHz, VOUT2= -10.0V

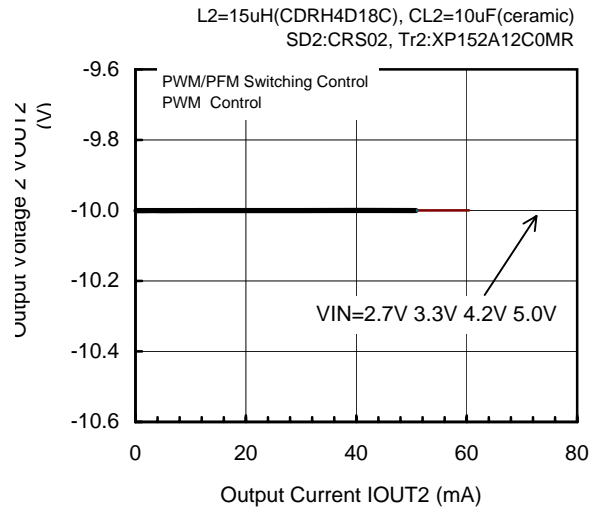

< 2 ch. Inverting DC/DC Controller >

(4) Output Voltage vs. Output Current (Continued)

(Tantalum Capacitor use)

FOSC=180kHz, VOUT2= -7.5V

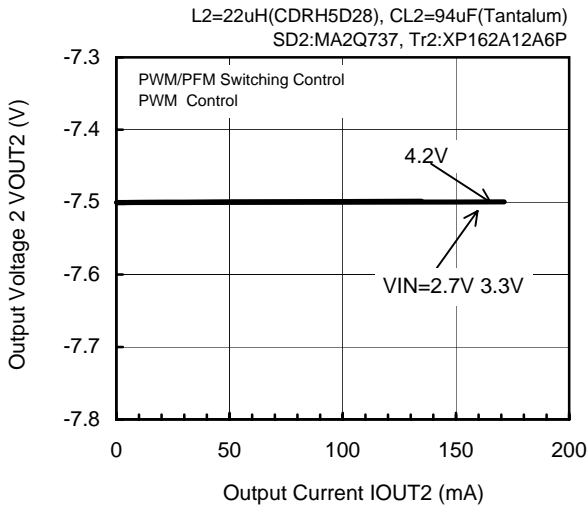

FOSC=180kHz, VOUT2= -10.0V

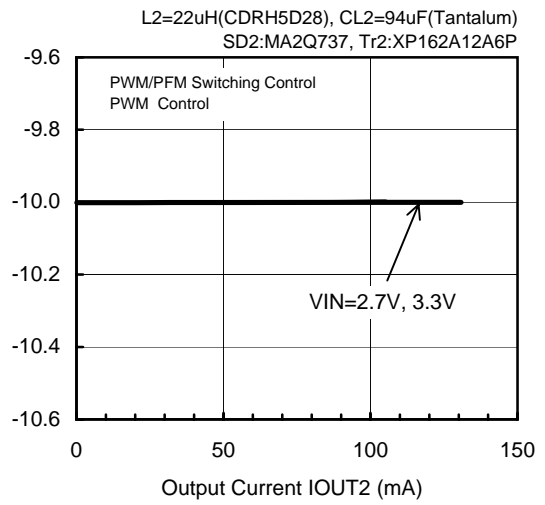

FOSC=300kHz, VOUT2= -5.0V

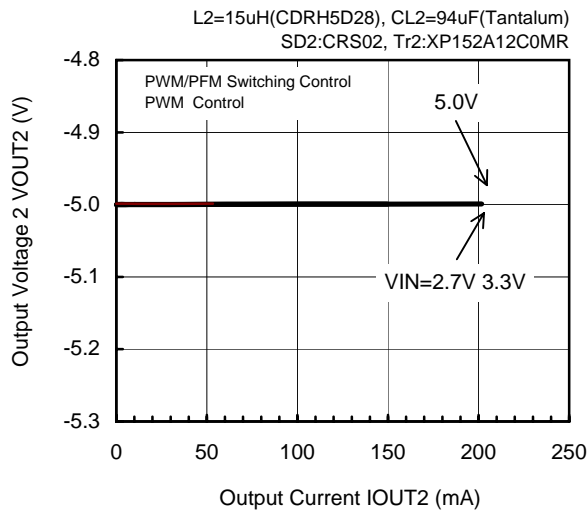

FOSC=300kHz, VOUT2= -7.5V

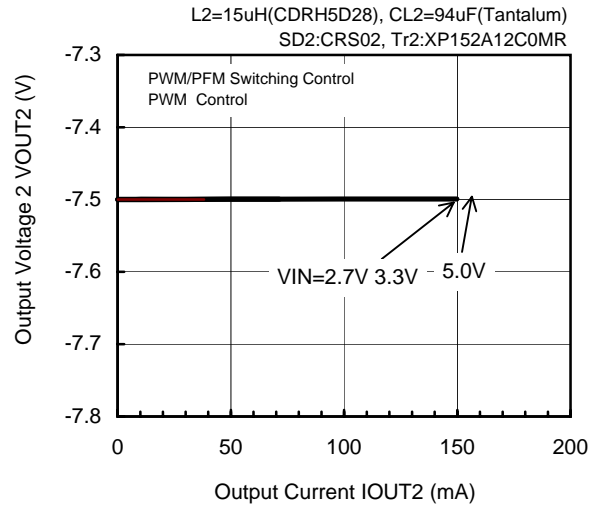

FOSC=300kHz, VOUT2= -10.0V

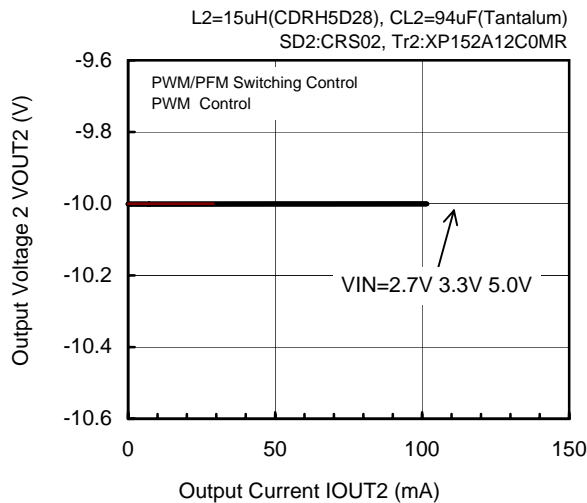

FOSC=300kHz, VOUT2= -15.0V

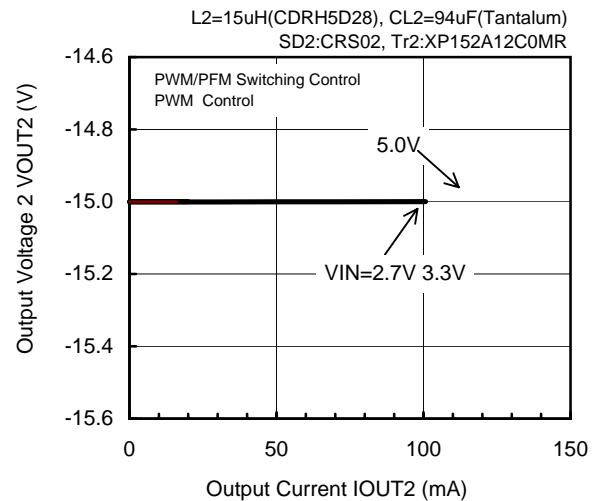

< 2 ch. Inverting DC/DC Controller >

(5) Efficiency vs. Output Current

(Ceramic Capacitor and Compact Inductor use)

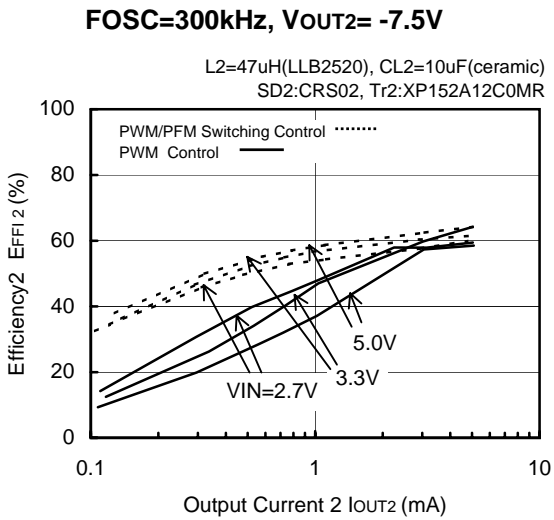
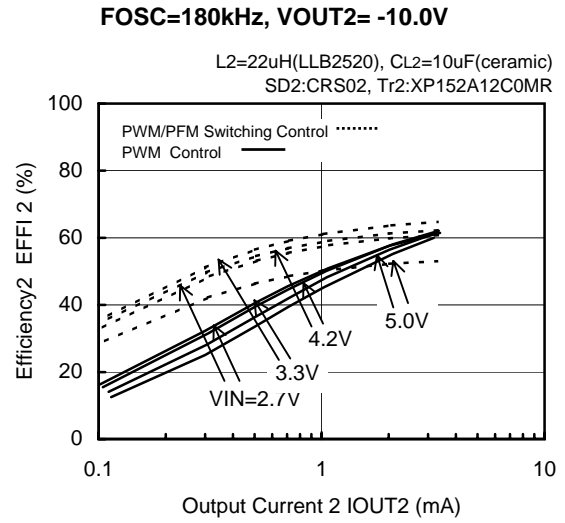
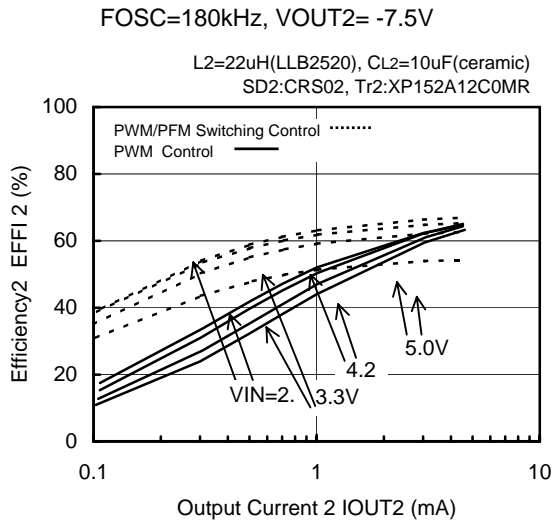

< 2 ch. Inverting DC/DC Controller >

(5) Efficiency vs. Output Current (Continued)

(Ceramic Capacitor use)

FOSC=180kHz, VOUT2= -7.5V

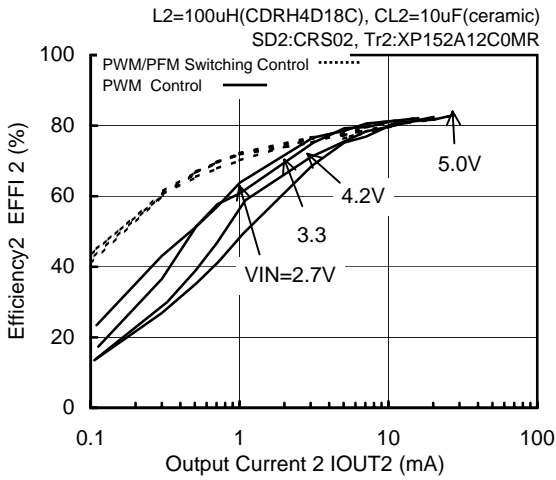

FOSC=180kHz, VOUT2= -10.0V

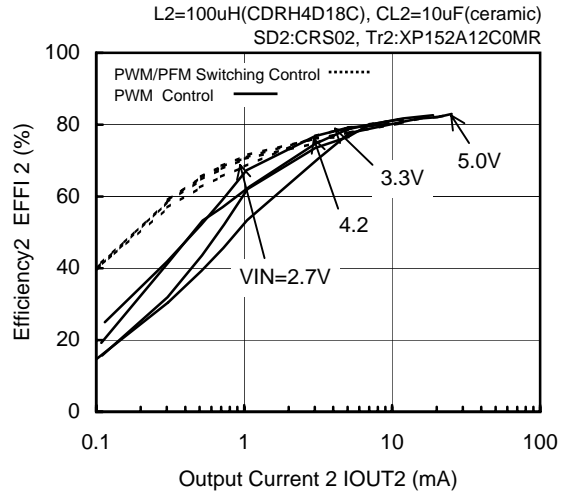

FOSC=180kHz, VOUT2= -7.5V

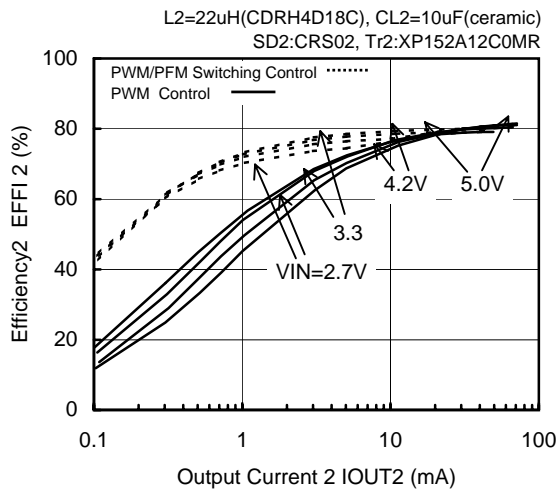

FOSC=180kHz, VOUT2= -10.0V

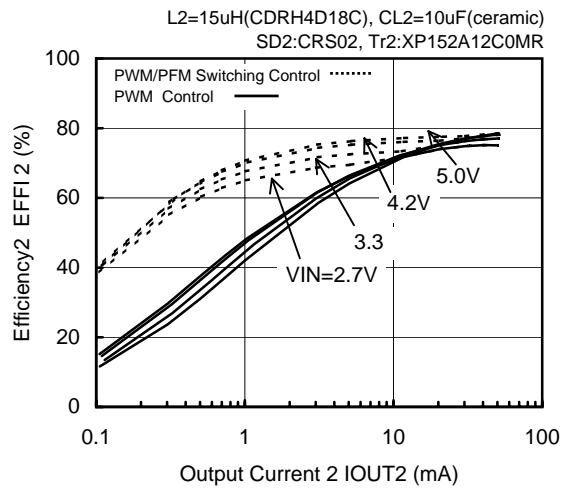

< 2 ch. Inverting DC/DC Controller >

(5) Efficiency vs. Output Current (Continued)

(Tantalum Capacitor use)

FOSC=180kHz, VOUT2= -7.5V

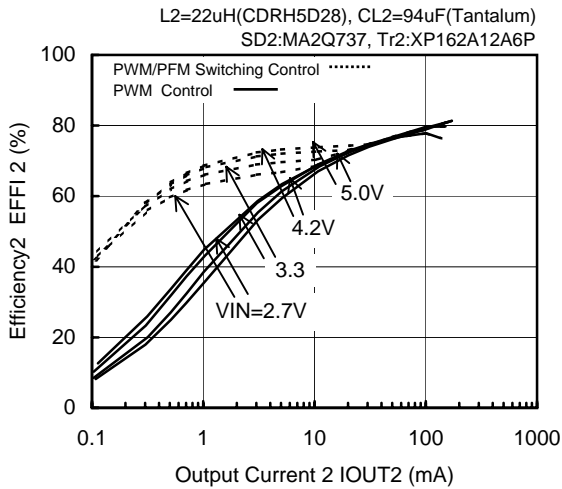

FOSC=180kHz, VOUT2= -10.0V

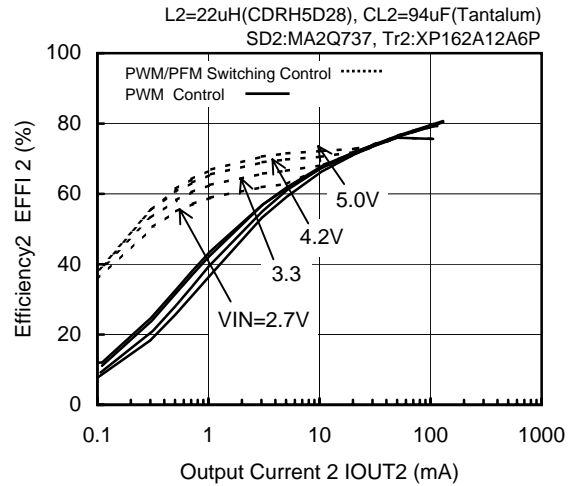

FOSC=300kHz, VOUT2= -5.0V

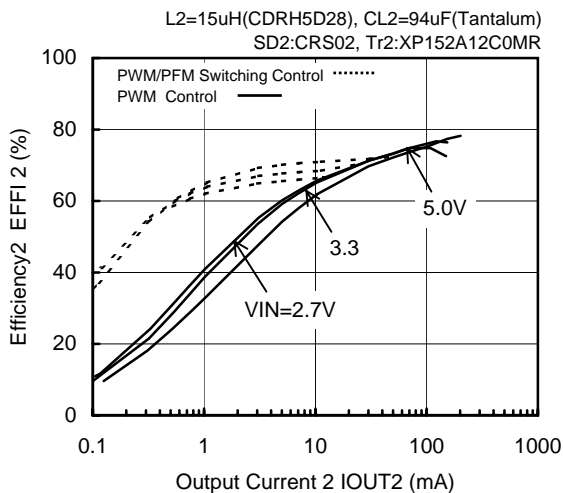

FOSC=300kHz, VOUT2= -7.5V

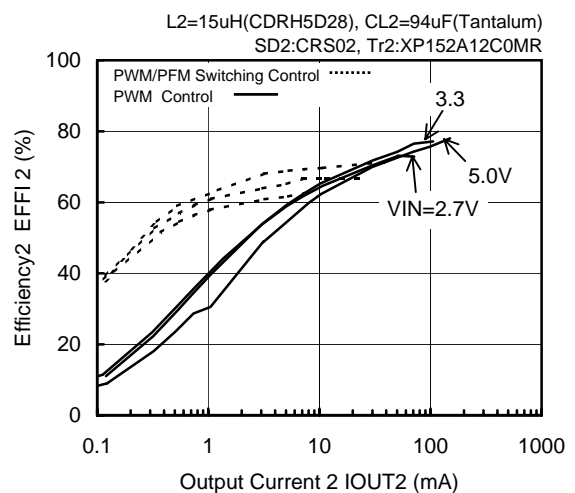

FOSC=300kHz, VOUT2= -10.0V

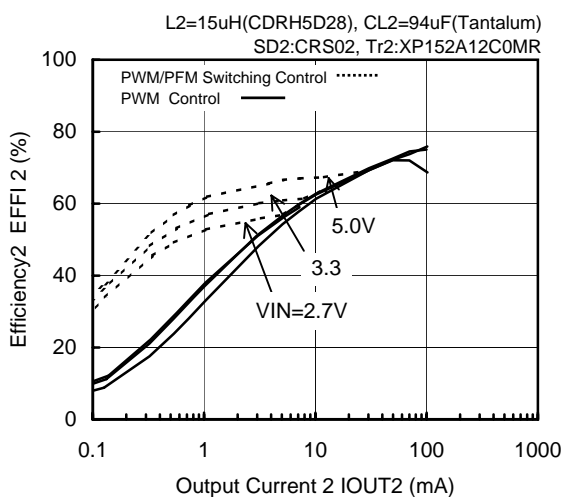

FOSC=300kHz, VOUT2= -15.0V

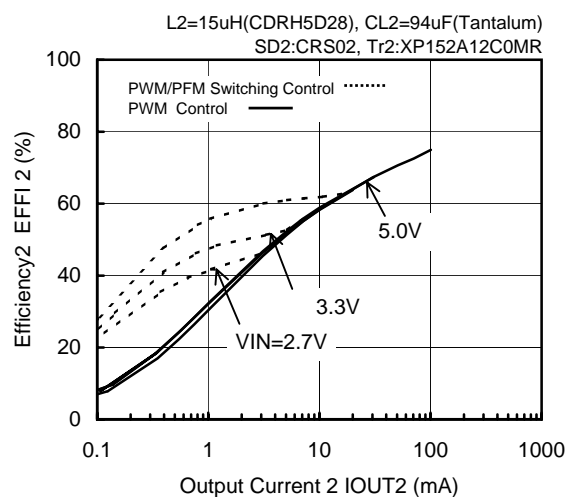

< 2 ch. Inverting DC/DC Controller >

(5) Ripple Voltage vs. Output Current

(Ceramic Capacitor and Compact Inductor use)

FOSC=180kHz, VOUT2= -7.5V

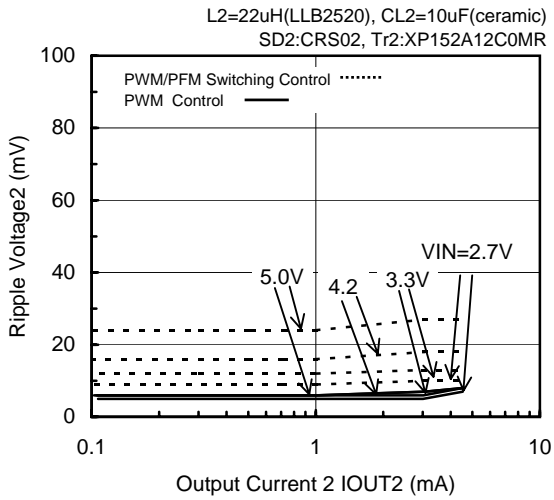

FOSC=180kHz, VOUT2= -10.0V

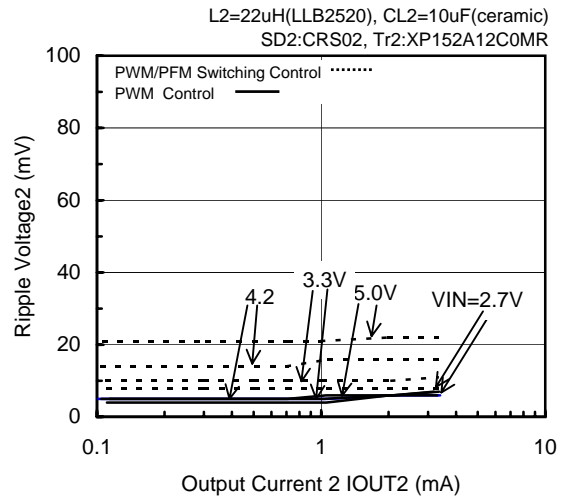

FOSC=300kHz, VOUT2= -7.5V

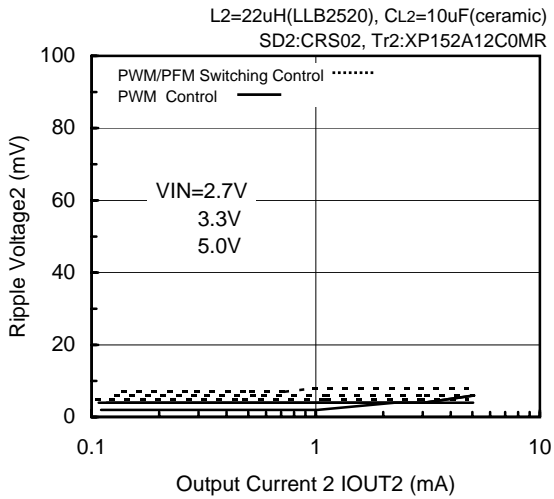

< 2 ch. Inverting DC/DC Controller >

(5) Ripple Voltage vs. Output Current (Continued)

(Ceramic Capacitor use)

FOSC=180kHz, VOUT2= -7.5V

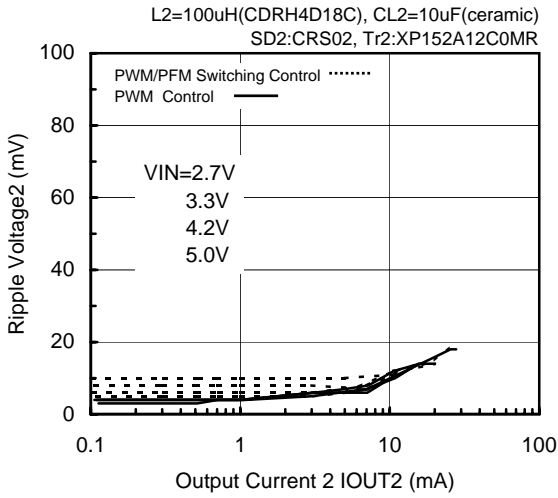

FOSC=180kHz, VOUT2= -10.0V

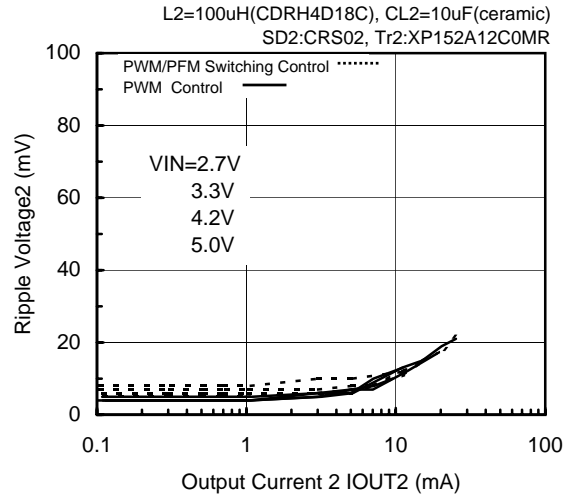

FOSC=180kHz, VOUT2= -7.5V

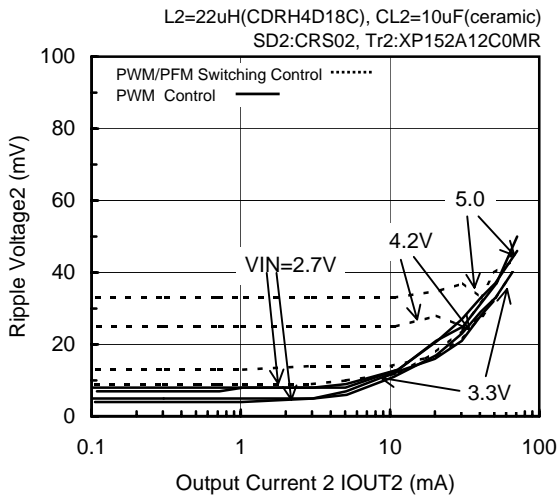

FOSC=180kHz, VOUT2= -10.0V

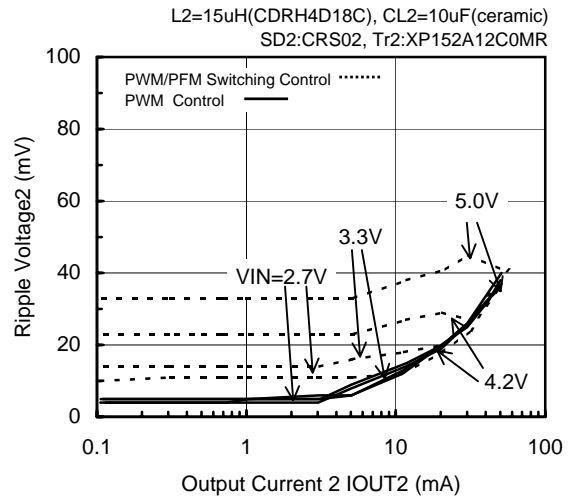

< 2 ch. Inverting DC/DC Controller >

(5) Ripple Voltage vs. Output Current (Continued)

(Tantalum Capacitor use)

FOSC=180kHz, VOUT2= -7.5V

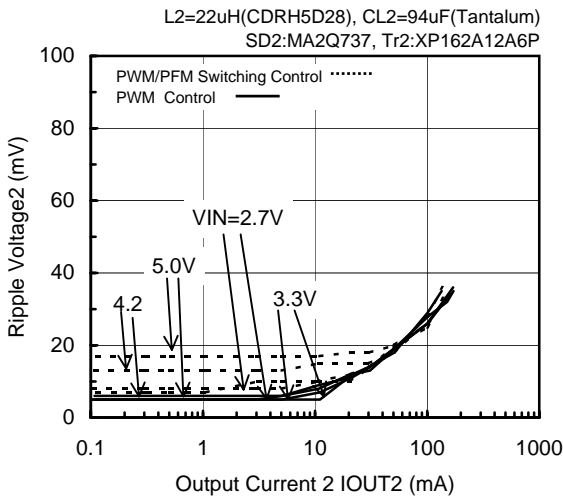

FOSC=180kHz, VOUT2= -10.0V

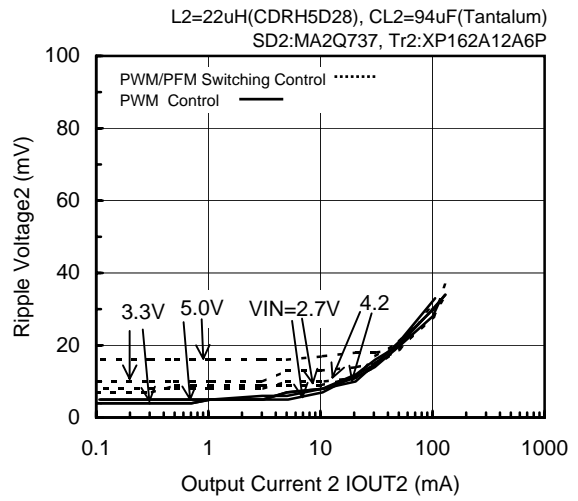

FOSC=300kHz, VOUT2= -5.0V

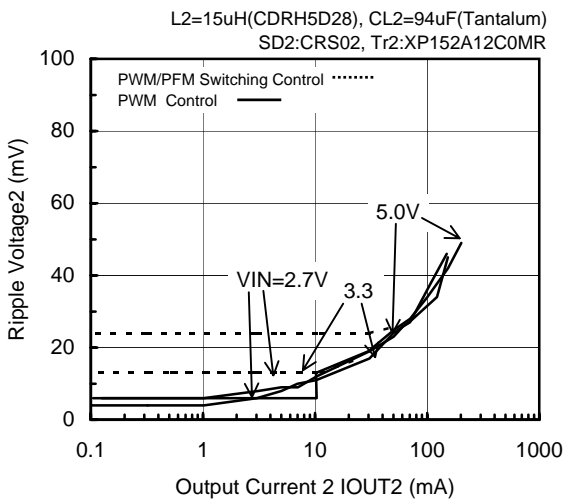

FOSC=300kHz, VOUT2= -7.5V

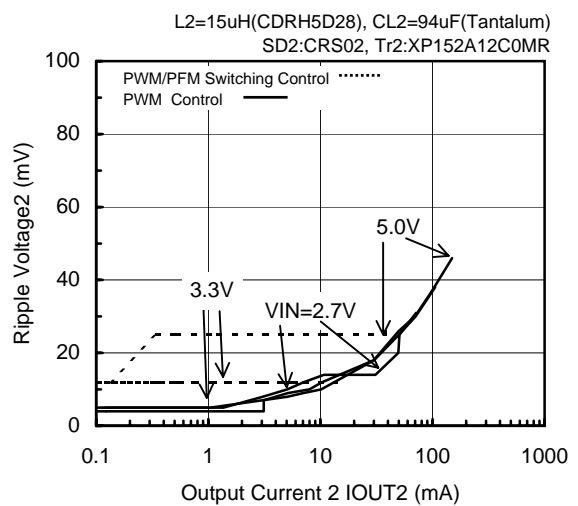

FOSC=300kHz, VOUT2= -10.0V

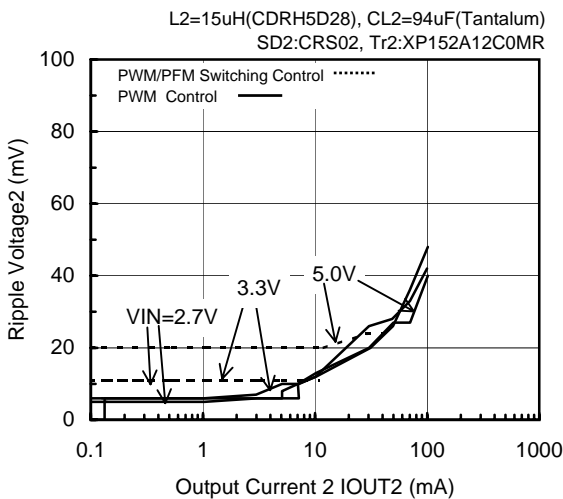

FOSC=180kHz, VOUT2= -15.0V

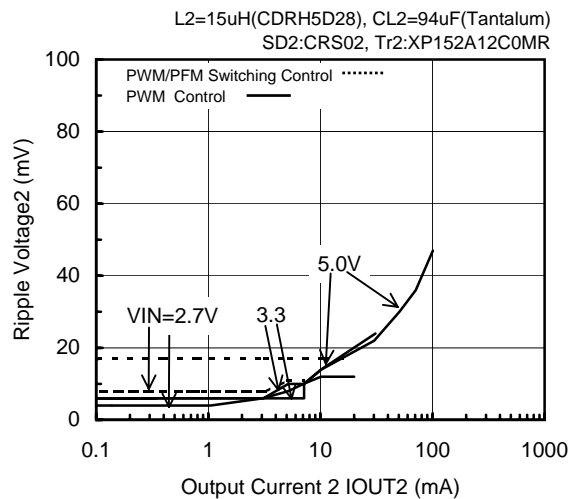

< 2 ch. Inverting DC/DC Controller >

(7) Breakdown of Output Voltage

FOSC=300kHz, VIN= 3.3V

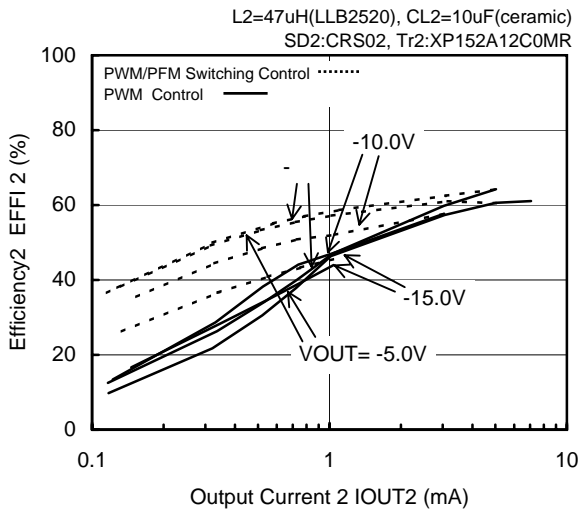

FOSC=300kHz, VIN= 3.3V

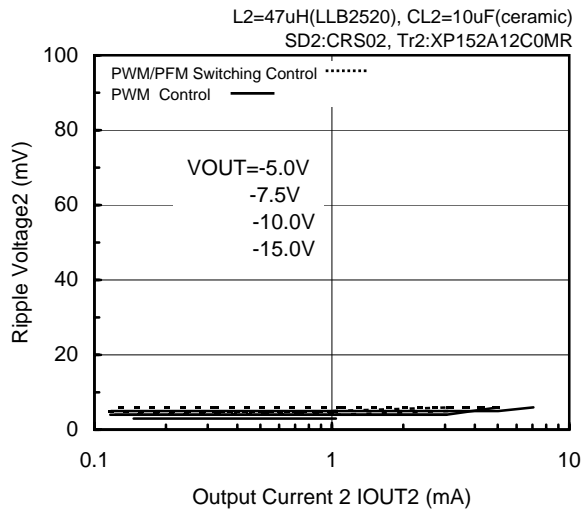

FOSC=300kHz, VIN= 3.3V

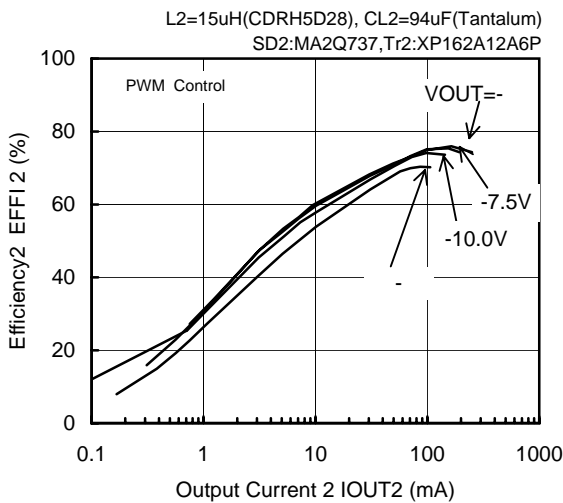

FOSC=300kHz, VIN= 3.3V

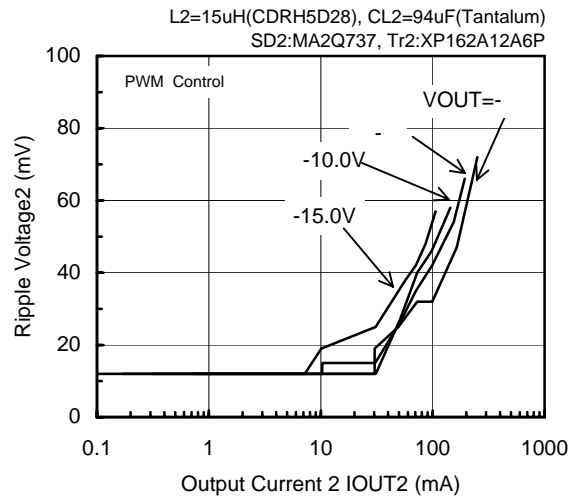

FOSC=500kHz, VIN= 3.3V

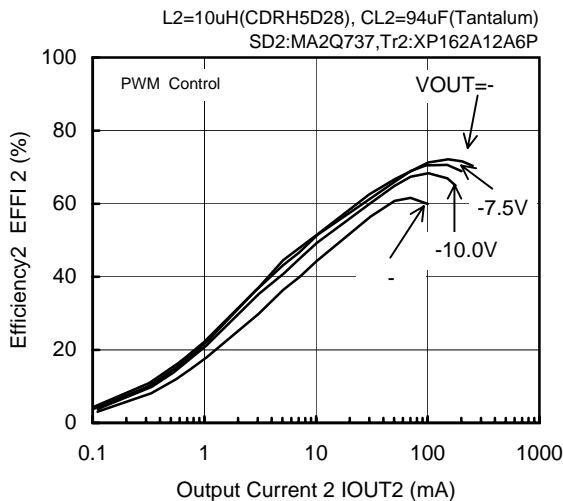

FOSC=500kHz, VIN= 3.3V

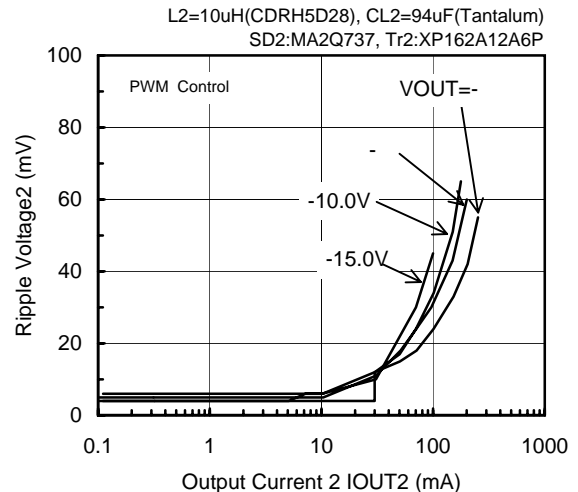

< 2 ch. Inverting DC/DC Controller >

(7) Breakdown of Coil Inductance Value

FOSC=300kHz, VIN=3.3V, Output2= -7.5V

L2=CDRH5D28, CL2=94uF(Tantalum)
SD2:MA2Q737, Tr2:XP162A12C0MR

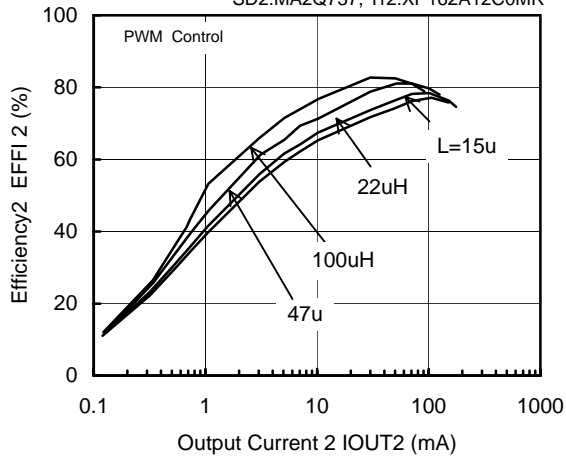

FOSC=300kHz, VIN=3.3V, Output2= -7.5V

L2=CDRH5D28, CL2=94uF(Tantalum)
SD2:MA2Q737, Tr2:XP162A12A6P

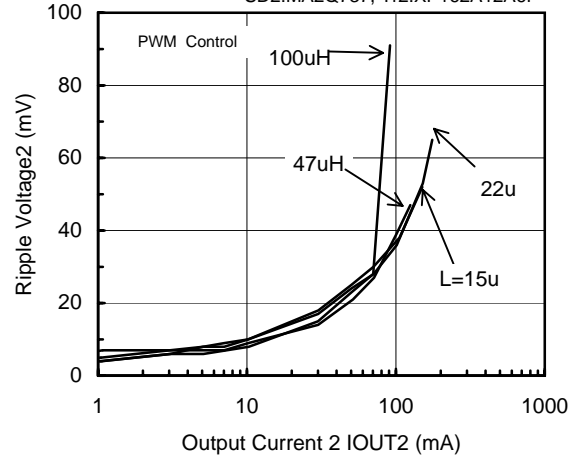

Typical Performance Characteristics (Continued)

(8) Supply Current vs. Supply Voltage

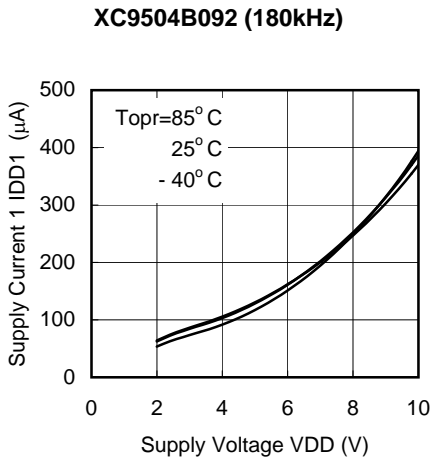

(9) Supply Current vs. Supply Voltage

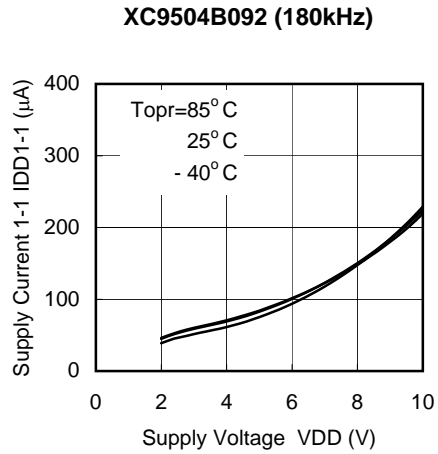

(10) Supply Current 1-2 vs. Supply Voltage

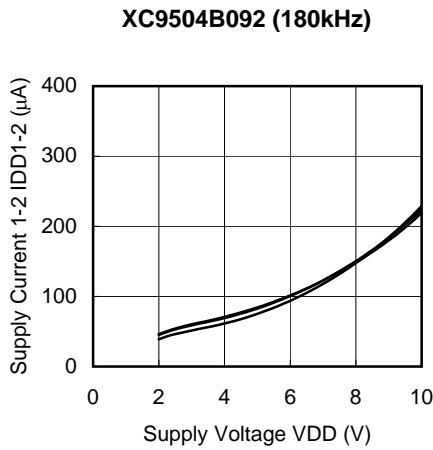

(11) Supply Current 2 vs. Supply Voltage

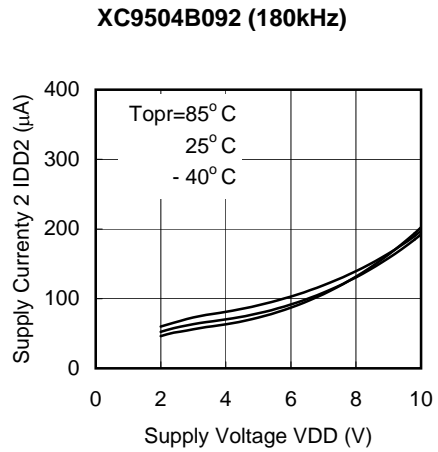

(12) Standby Current vs. Supply Voltage

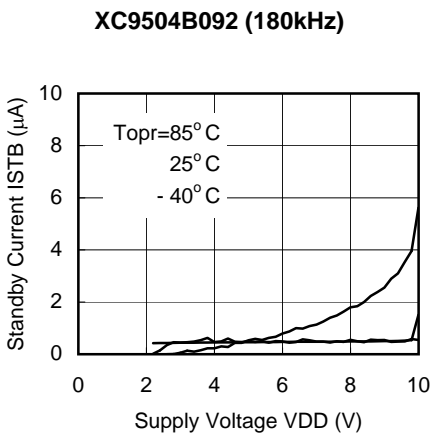

(13) Oscillation Frequency vs. Supply Voltage

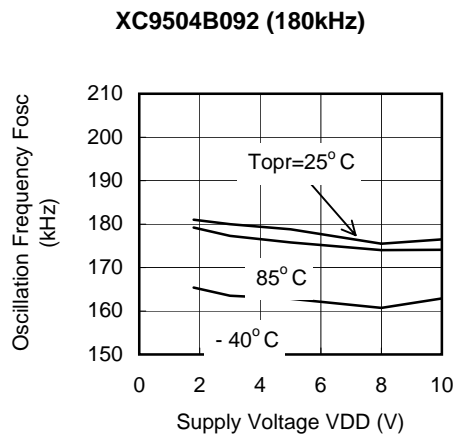

(14) PWM1, 2 'H' 'L' Voltage vs. Supply Voltage

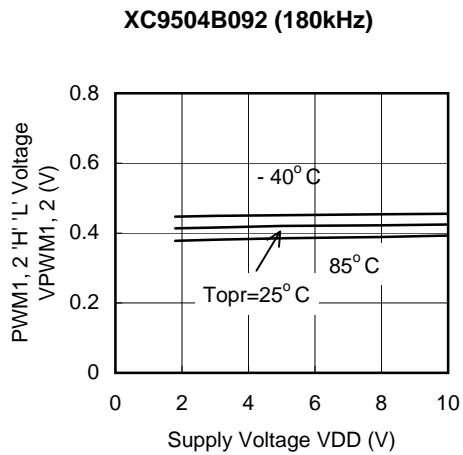

(15) EN1, 2 'H' 'L' Voltage vs. Supply Voltage

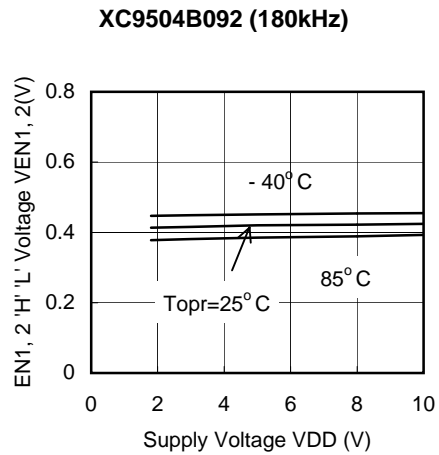

(16) Maximum Duty Ratio 1, 2 vs. Supply Voltage

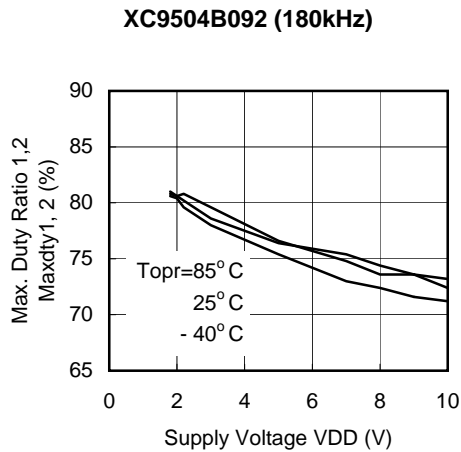

(17) Soft-start time 1 vs. Supply Voltage

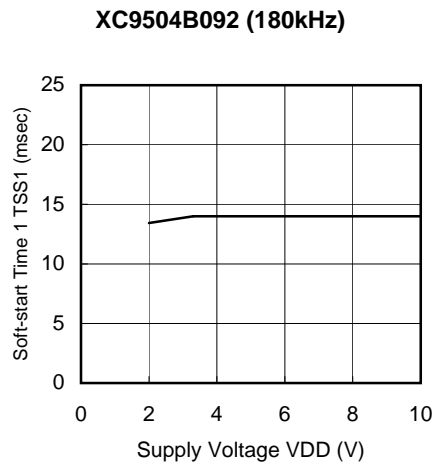

(18) EXT1, 2 High ON Resistance vs. Supply Voltage

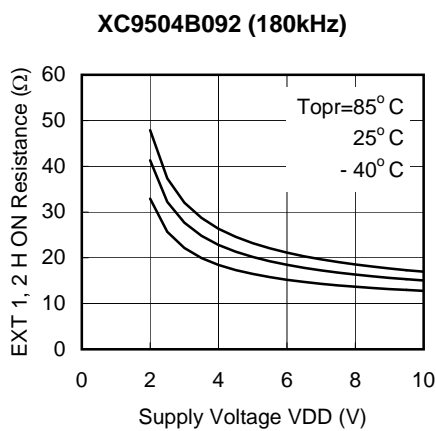

(19) EXT1, 2 Low ON Resistance vs. Supply Voltage

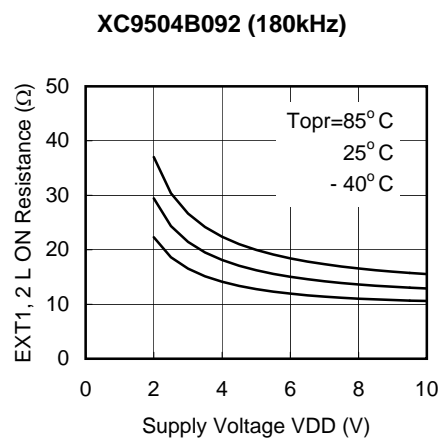

(20) Operation Start-Up Voltage vs. Ambient Temperature

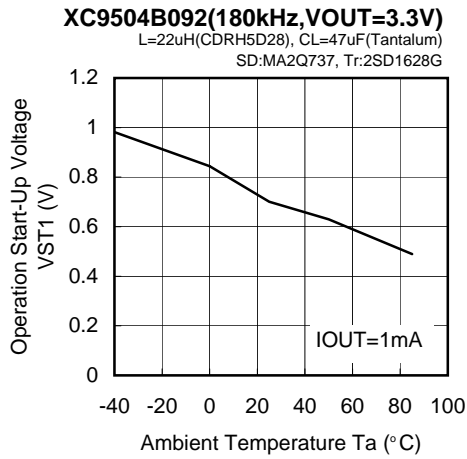

(21) Operation Retention Voltage vs. Ambient Temperature

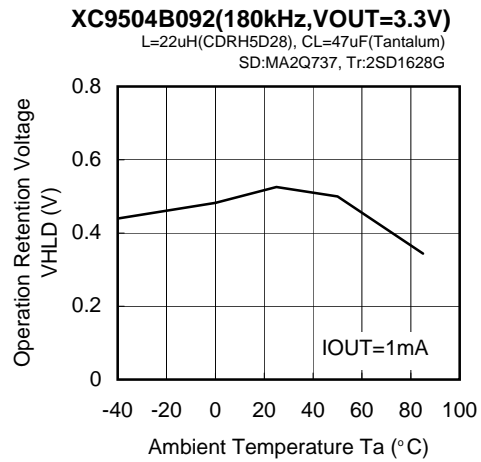

(22) Oscillation Start-Up Voltage vs. Ambient Temperature

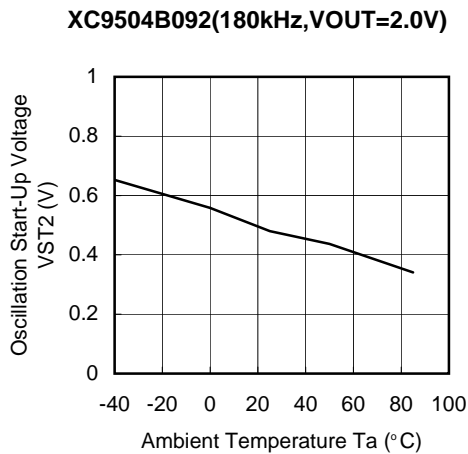

(23) PFM Duty Ratio 1,2 vs. Supply Voltage

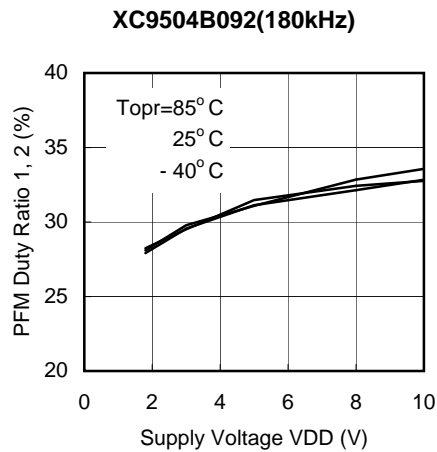

(24) Output Voltage vs. Ambient Temperature

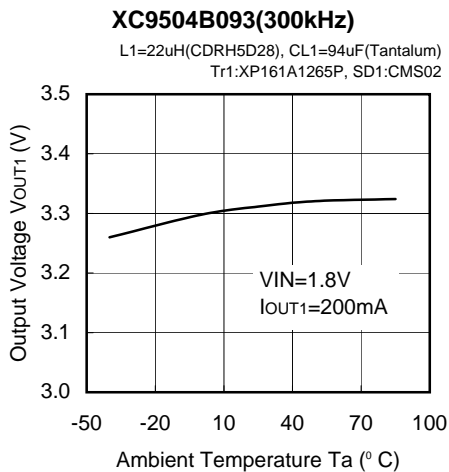

■ Load Transient Response
 < 1 ch. Step-Up DC/DC Controller >

(Tantalum Capacitor Use)

< VOUT1 = 3.3V, VIN = 2.0V IOUT1 = 100 μ A \leftrightarrow 100mA >

○ PWM Control

FOSC=180kHz, VOUT1=3.3V
 VIN=2.0V, IOUT1=100 μ A \rightarrow 100mA

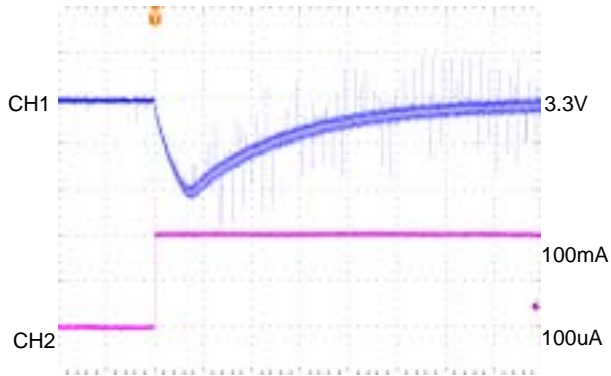

200uA/div
 CH1:Vout1 , AC-COUPLED, 50mV/div
 CH2:Iout1 , 50mA/div

FOSC=180kHz, VOUT1=3.3V
 VIN=2.0V, IOUT1=100mA \rightarrow 100 μ A

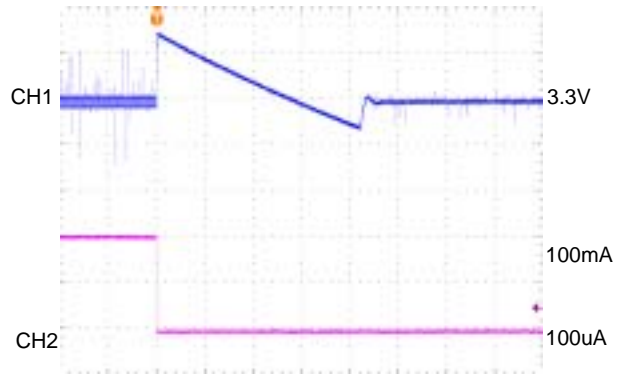

10msec/div
 CH1:Vout1 , AC-COUPLED, 50mV/div
 CH2:Iout1 , 50mA/div

○ PWM/PFM Switching Control

FOSC=180kHz, VOUT1=3.3V
 VIN=2.0V, IOUT1=100 μ A \rightarrow 100mA

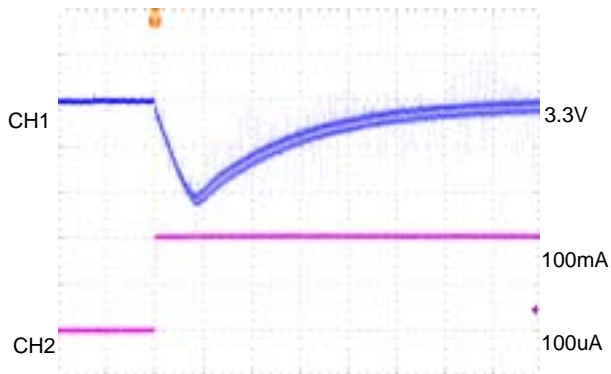

200uA/div
 CH1:Vout1 , AC-COUPLED, 50mV/div
 CH2:Iout1 , 50mA/div

FOSC=180kHz, VOUT1=3.3V
 VIN=2.0V, IOUT1=100mA \rightarrow 100 μ A

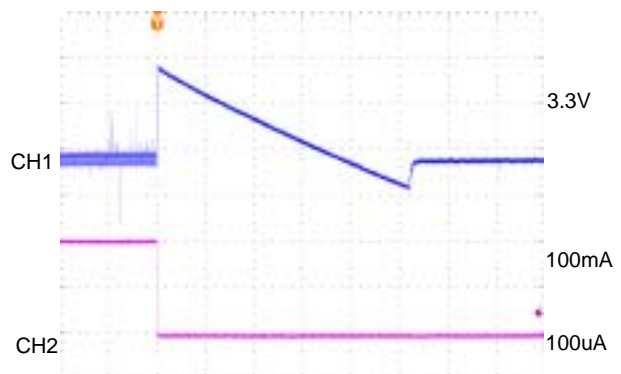

10msec/div
 CH1:Vout1 , AC-COUPLED, 50mV/div
 CH2:Iout1 , 50mA/div

< 1 ch. Step-Up DC/DC Controller >

(Tantalum Capacitor Use)

< V_{OUT1} = 3.3V, V_{IN} = 2.0V I_{OUT1} = 10mA ↔ 100mA >

○ PWM Control

FOSC=180kHz, V_{OUT1}=3.3V
VIN=2.0V, I_{OUT1}=10mA→ 100mA

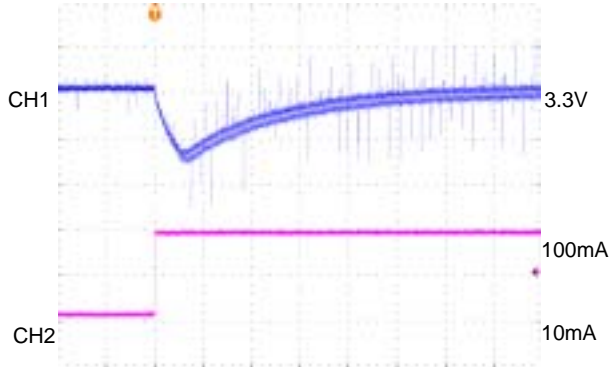

200usec/div
CH1:V_{OUT1} , AC-COUPLED, 50mV/div
CH2:I_{OUT1} , 50mA/div

FOSC=180kHz, V_{OUT1}=3.3V
VIN=2.0V, I_{OUT1}=100mA→ 10mA

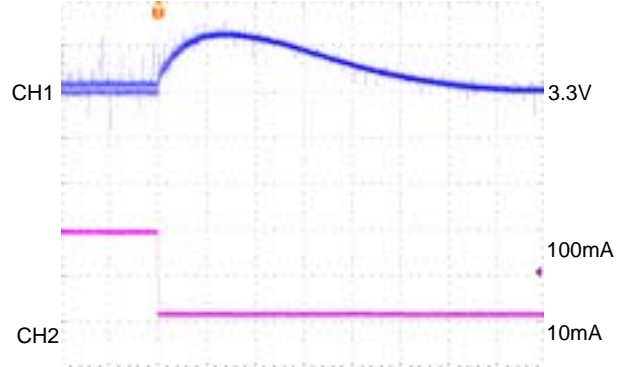

200usec/div
CH1:V_{OUT1} , AC-COUPLED, 50mV/div
CH2:I_{OUT1} , 50mA/div

○ PWM/PFM Switching Control

FOSC=180kHz, V_{OUT1}=3.3V
VIN=2.0V, I_{OUT1}=10mA→ 100mA

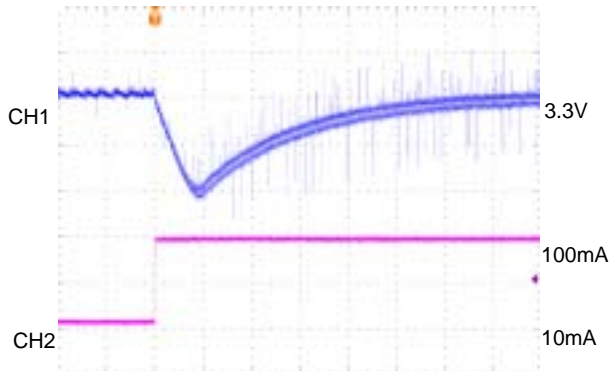

200usec/div
CH1:V_{OUT1} , AC-COUPLED, 50mV/div
CH2:I_{OUT1} , 50mA/div

FOSC=180kHz, V_{OUT1}=3.3V
VIN=2.0V, I_{OUT1}=100mA→ 10mA



200usec/div
CH1:V_{OUT1} , AC-COUPLED, 50mV/div
CH2:I_{OUT1} , 50mA/div

< 1 ch. Step-Up DC/DC Controller >

(Ceramic Capacitor Use when coil current is discontinuous.)

< VOUT1 = 15.0V, VIN = 3.3V IOUT1 = 100uA ⇔ 20mA >

○ PWM Control

FOSC=180kHz, VOUT1=15.0V
VIN=3.3V, IOUT1=100uA → 20mA

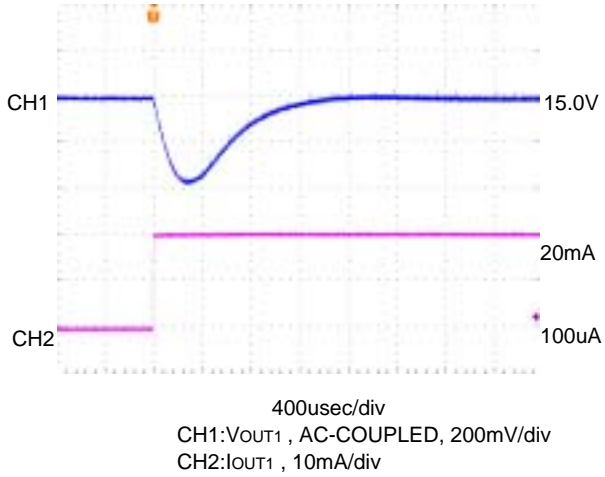

FOSC=180kHz, VOUT1=15.0V
VIN=3.3V, IOUT1=20mA → 100uA

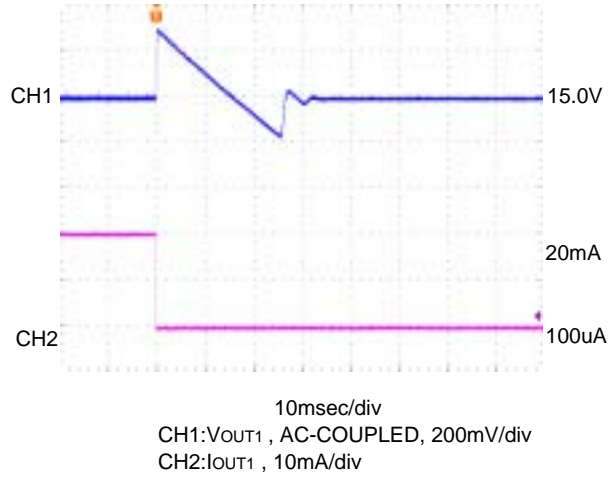

○ PWM/PFM Switching Control

FOSC=180kHz, VOUT1=15.0V
VIN=3.3V, IOUT1=100uA → 20mA

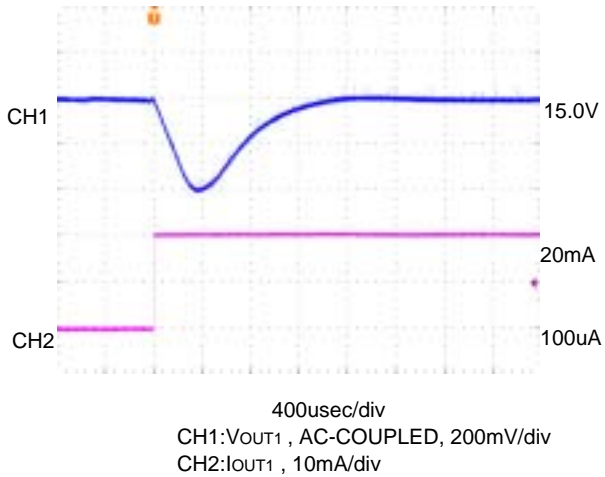

FOSC=180kHz, VOUT1=15.0V
VIN=3.3V, IOUT1=20mA → 100uA

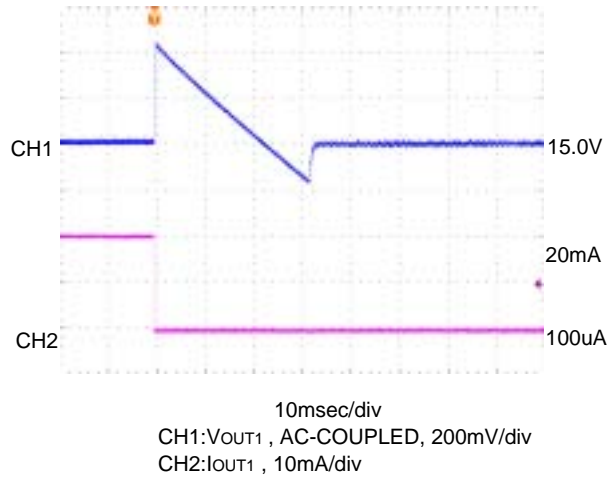

< 1 ch. Step-Up DC/DC Controller >

(Ceramic Capacitor Use when coil current is discontinuous.)

< VOUT1 = 15.0V, VIN = 3.3V IOUT1 = 1mA ⇔ 20mA >

○ PWM Control

FOSC=180kHz, VOUT1=15.0V
VIN=3.3V, IOUT1=1mA → 20mA

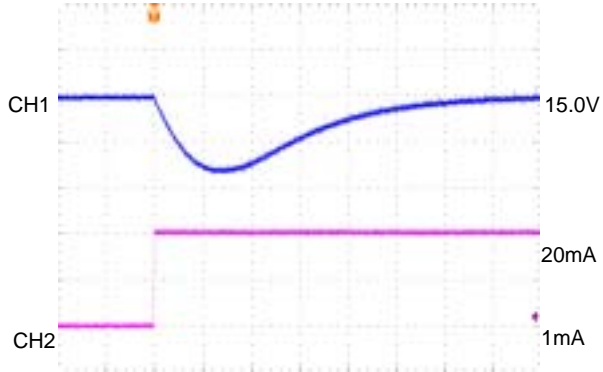

200usec/div
CH1:Vout1 , AC-COUPLED, 200mV/div
CH2:IOUT1 , 10mA/div

FOSC=180kHz, VOUT1=15.0V
VIN=3.3V, IOUT1=20mA → 1mA

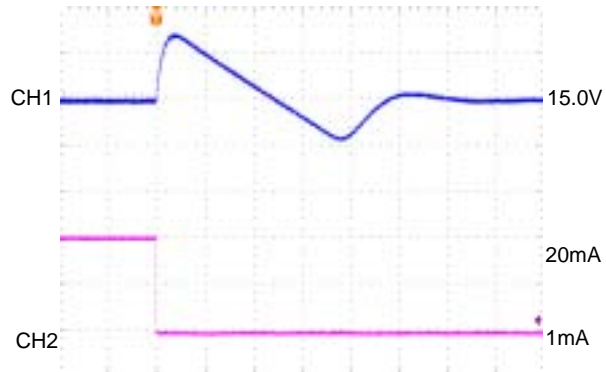

1msec/div
CH1:Vout1 , AC-COUPLED, 200mV/div
CH2:IOUT1 , 10mA/div

○ PWM/PFM Switching Control

FOSC=180kHz, VOUT1=15.0V
VIN=3.3V, IOUT1=1mA → 20mA

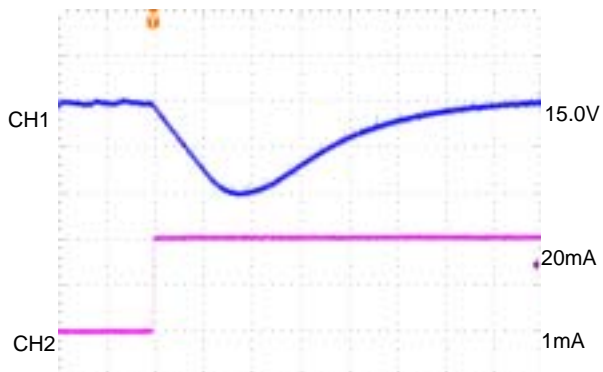

200usec/div
CH1:Vout1 , AC-COUPLED, 20mV/div
CH2:IOUT1 , 10mA/div

FOSC=180kHz, VOUT1=15.0V
VIN=3.3V, IOUT1=20mA → 1mA

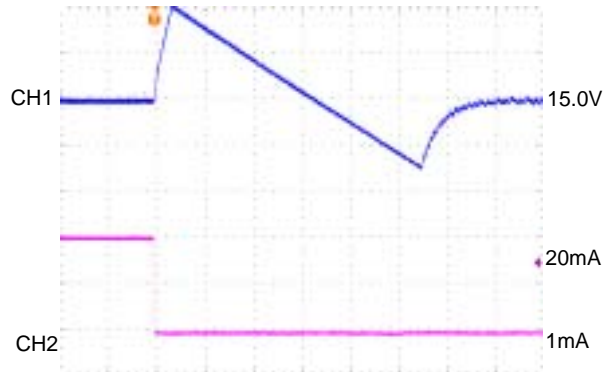

1msec/div
CH1:Vout1 , AC-COUPLED, 200mV/div
CH2:IOUT1 , 10mA/div

< 1 ch. Step-Up DC/DC Controller >

(Ceramic Capacitor Use when coil current is discontinuous.)

< PWM Control ⇔ PWM / PFM Switching Control >

FOSC=180kHz, VOUT1=3.3V
VIN=2.0V, IOU1=1mA PWM1 'L' → 'H'

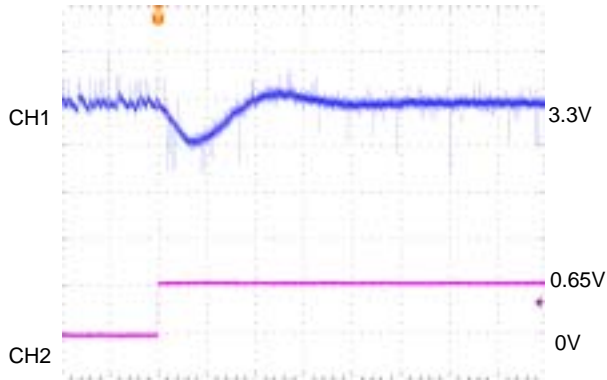

1msec/div
CH1:VOUT1, AC-COUPLED, 10mV/div
CH2:PWM1, 0.5V/div

FOSC=180kHz, VOUT1=3.3V
VIN=2.0V, IOU1=1mA PWM1 'H' → 'L'

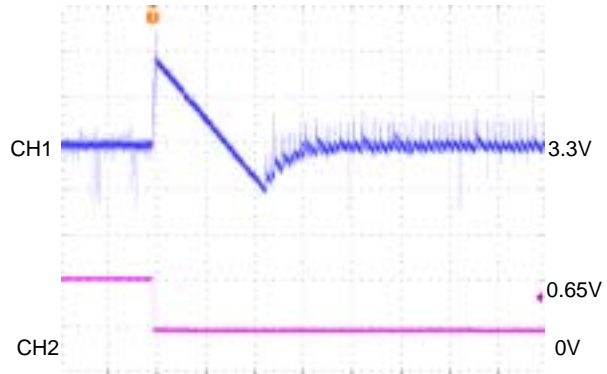

1msec/div
CH1:VOUT1, AC-COUPLED, 10mV/div
CH2:PWM1, 0.5V/div

<Soft-start Wave Form>

FOSC=180kHz, VOUT1=3.3V
VIN=2.0V, IOU1=100mA EN1 'L' → 'H', CIN=47uF

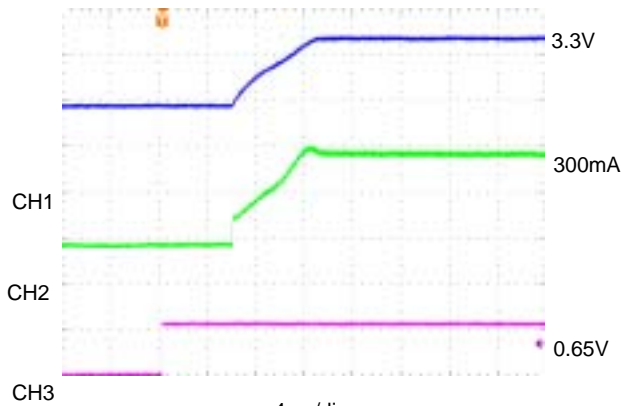

4ms/div
CH1:VOUT1, 1.0V/div
CH2:IIN1, 100mA/div
CH3:EN1, 0.5V/div

* EN2=GND

< 2 ch. Inverting DC/DC Controller >

(Tantalum Capacitor Use)

< VOUT2 = -7.5V, VIN = 3.3V IOUT2 = 100uA ↔ - 50mA >

○ PWM Control

FOSC=180kHz, VOUT2=-7.5V
VIN=3.3V, IOUT2=-100uA → -50mA

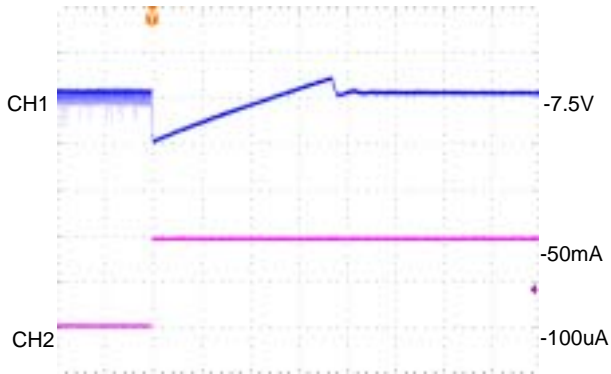

10msec/div
CH1:Vout2 , AC-COUPLED, 50mV/div
CH2:Iout2 , 50mA/div

FOSC=180kHz, VOUT2=-7.5V
VIN=3.3V, IOUT2=-50mA → -100uA

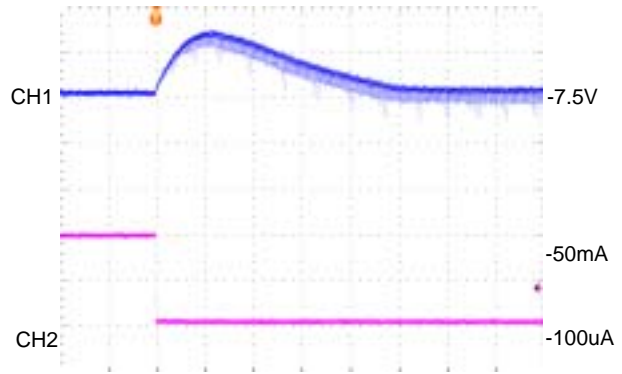

200usec/div
CH1:Vout2 , AC-COUPLED, 50mV/div
CH2:Iout2 , 50mA/div

○ PWM/PFM Switching Control

FOSC=180kHz, VOUT2=-7.5V
VIN=3.3V, IOUT2=-100uA → -50mA

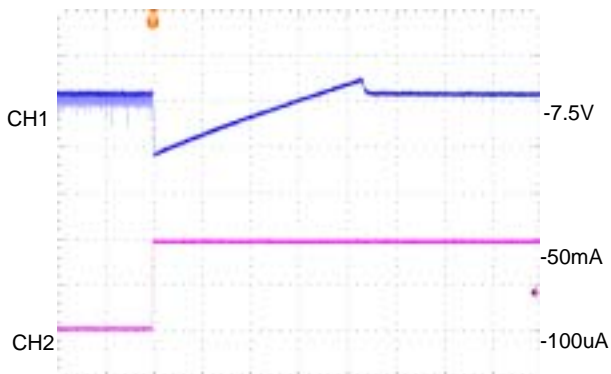

10msec/div
CH1:Vout2 , AC-COUPLED, 50mV/div
CH2:Iout2 , 50mA/div

FOSC=180kHz, VOUT2=-7.5V
VIN=3.3V, IOUT2=-50mA → -100uA

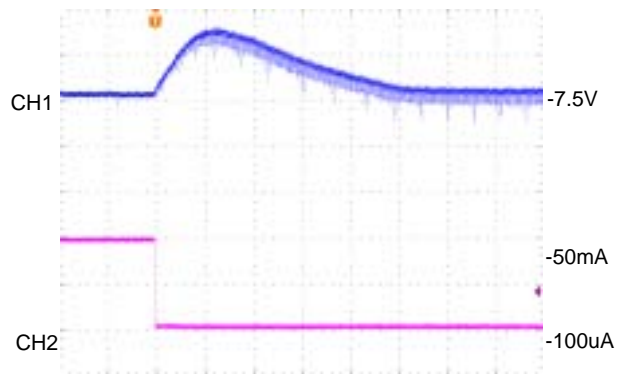

200usec/div
CH1:Vout2 , AC-COUPLED, 50mV/div
CH2:Iout2 , 50mA/div

< 2 ch. Inverting DC/DC Controller >

(Ceramic Capacitor Use when coil current is discontinuous.)

< VOUT2 = -7.5V, VIN = 3.3V IOUT2 = 100uA ⇔ - 20mA >

○ PWM Control

FOSC=180kHz, VOUT2=-7.5V
VIN=3.3V, IOUT2=-100uA → -20mA

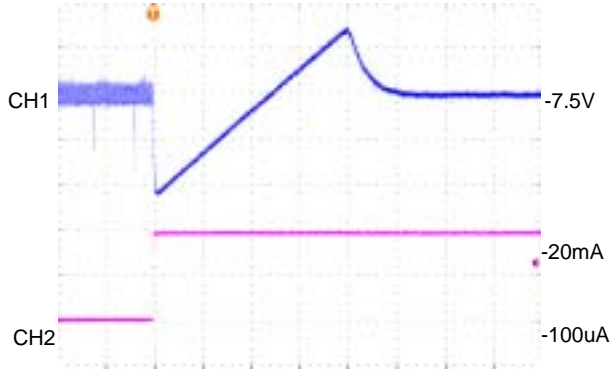

1msec/div
CH1:Vout2 , AC-COUPLED, 20mV/div
CH2:Iout2 , 10mA/div

FOSC=180kHz, VOUT2=-7.5V
VIN=3.3V, IOUT2=-20mA → -100uA

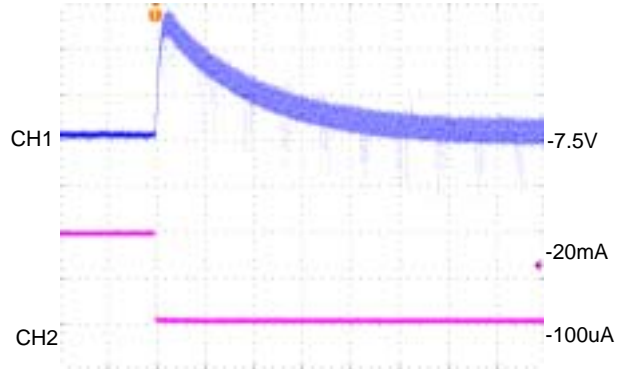

200usec/div
CH1:Vout2 , AC-COUPLED, 20mV/div
CH2:Iout2 , 10mA/div

○ PWM/PFM Switching Control

FOSC=180kHz, VOUT2=-7.5V
VIN=3.3V, IOUT2=-100uA → -20mA

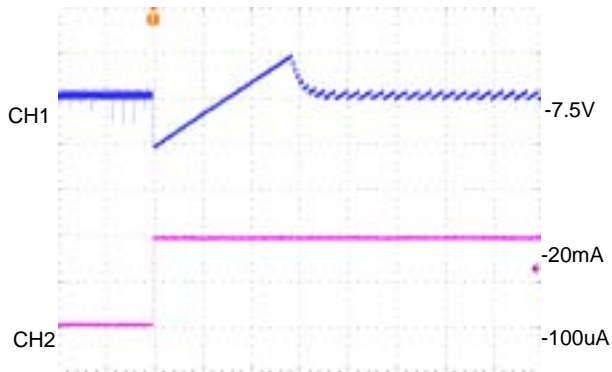

2msec/div
CH1:Vout2 , AC-COUPLED, 50mV/div
CH2:Iout2 , 10mA/div

FOSC=180kHz, VOUT2=-7.5V
VIN=3.3V, IOUT2=-20mA → -100uA

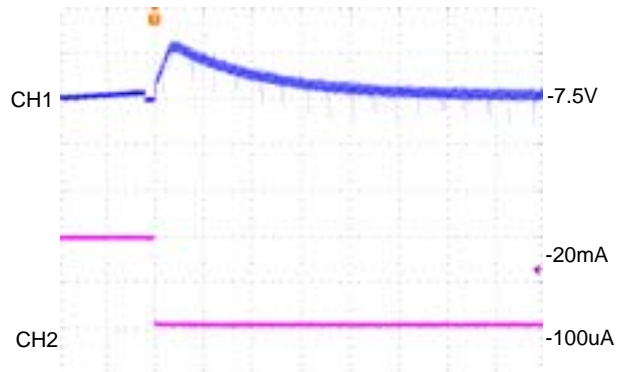

200usec/div
CH1:Vout2 , AC-COUPLED, 50mV/div
CH2:Iout2 , 10mA/div

< 2 ch. Inverting DC/DC Controller >

(Ceramic Capacitor Use when coil current is discontinuous.)

< VOUT2 = -7.5V, VIN = 3.3V IOUT2 = 1mA ⇔ - 20mA >

○ PWM Control

FOSC=180kHz, VOUT2=-7.5V
VIN=3.3V, IOUT2=-1mA → -20mA

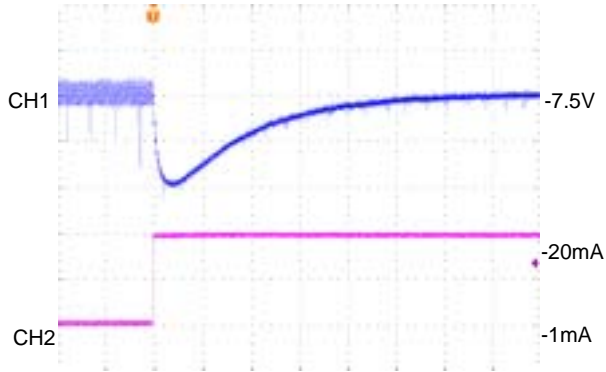

200usec/div
CH1:Vout2 , AC-COUPLED, 20mV/div
CH2:Iout2 , 10mA/div

FOSC=180kHz, VOUT2=-7.5V
VIN=3.3V, IOUT2=-20mA → -1mA

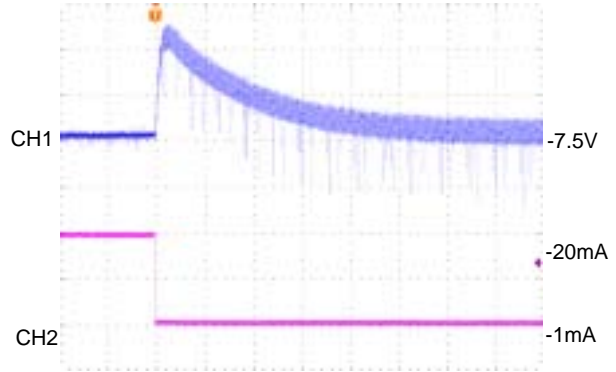

200usec/div
CH1:Vout2 , AC-COUPLED, 20mV/div
CH2:Iout2 , 10mA/div

○ PWM/PFM Switching Control

FOSC=180kHz, VOUT2=-7.5V
VIN=3.3V, IOUT2=-1mA → -20mA

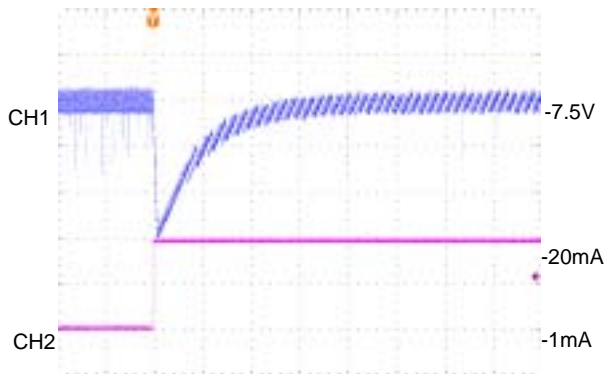

400usec/div
CH1:Vout2 , AC-COUPLED, 20mV/div
CH2:Iout2 , 10mA/div

FOSC=180kHz, VOUT2=-7.5V
VIN=3.3V, IOUT2=-20mA → -1mA

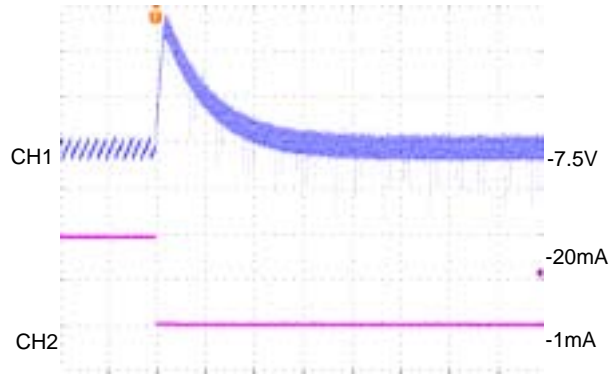

400usec/div
CH1:Vout2 , AC-COUPLED, 20mV/div
CH2:Iout2 , 10mA/div

< 2 ch. Inverting DC/DC Controller >

(Ceramic Capacitor Use when coil current is discontinuous.)

< PWM Control ⇔ PWM / PFM Switching Control >

FOSC=180kHz, VOUT2= - 7.5V
VIN=3.3V, IOU2=-5mA PWM2 'L'→'H'

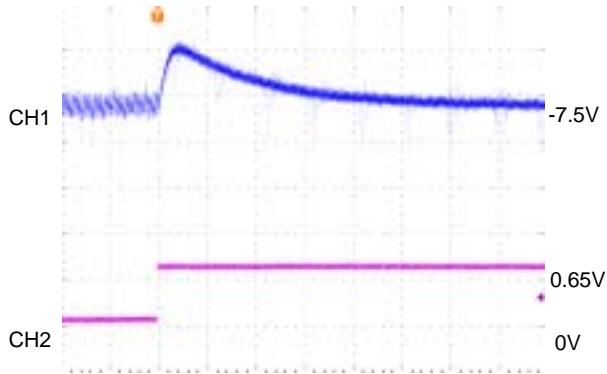

200µsec/div
CH1:VOUT₂, AC-COUPLED, 20mV/div
CH2:PWM₂, 0.5V/div

FOSC=180kHz, VOUT2=-7.5V
VIN=3.3V, IOU2=-5mA PWM2 'H'→'L'

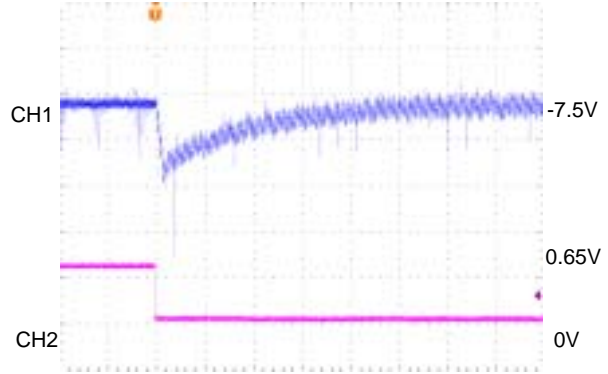

200µsec/div
CH1:VOUT₂, AC-COUPLED, 20mV/div
CH2:PWM₂, 0.5V/div

< 2 ch. Inverting DC/DC Controller >

(Ceramic Capacitor Use when coil current is discontinuous.)

< Soft-Start Wave Form >

FOSC=180kHz, VOUT2=-7.5V
VIN=3.3V, IOU2=-20mA EN1, 2 'L'→'H', CIN=10uF

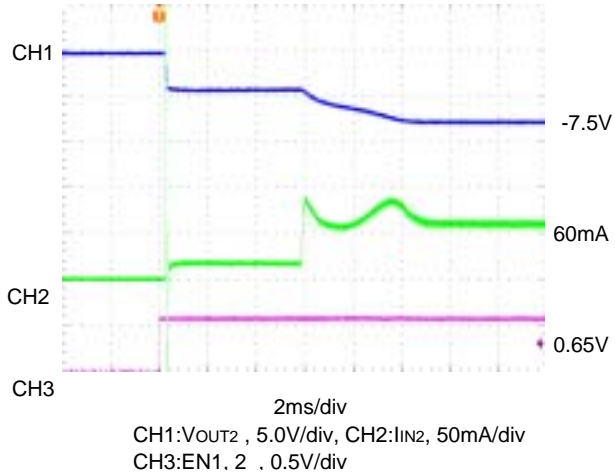

FOSC=180kHz, VOUT2=-7.5V
VIN=3.3V, IOU2=-50mA EN1, 2 'L'→'H', CIN=10uF

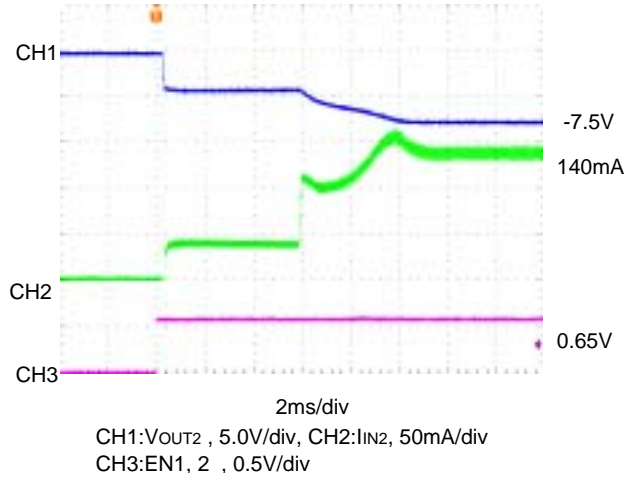

< Soft-Start Wave Form >

FOSC=180kHz, VOUT2=-7.5V
VIN=3.3V, IOU1=0mA, IOU2=-20mA EN1, 2 'L'→'H', CIN=10uF

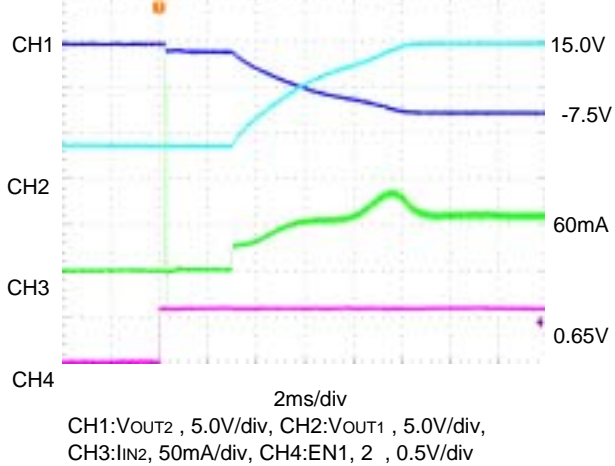

FOSC=180kHz, VOUT2=-7.5V
VIN=3.3V, IOU1=0mA, IOU2=-50mA EN1, 2 'L'→'H', CIN=10uF

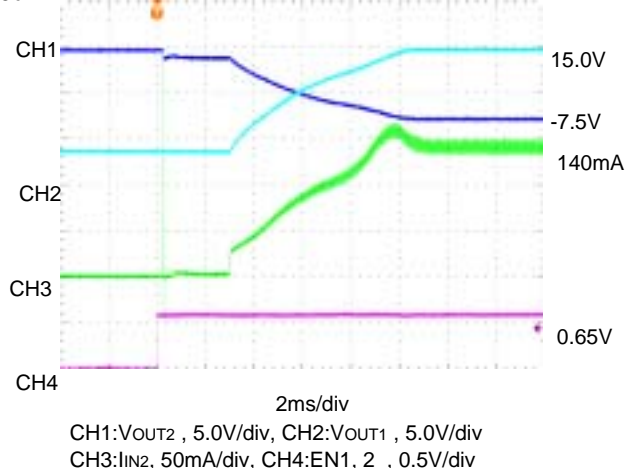

< Soft-Start Wave Form >

FOSC=180kHz, VOUT2=-7.5V
VIN=3.3V, IOU2=-20mA EN2 'L'→'H', CIN=10uF

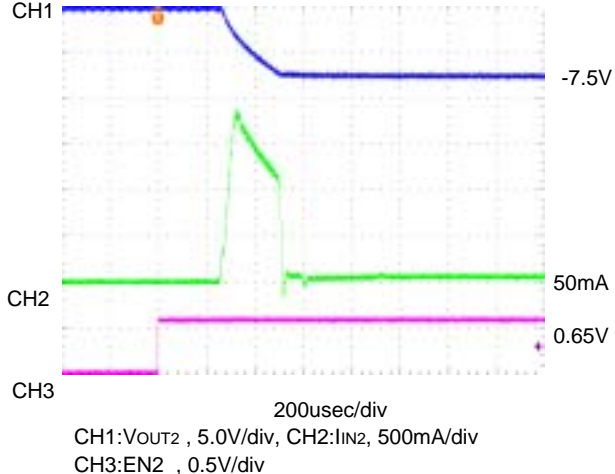

FOSC=180kHz, VOUT2=-7.5V
VIN=3.3V, IOU2=-50mA EN2 'L'→'H', CIN=10uF

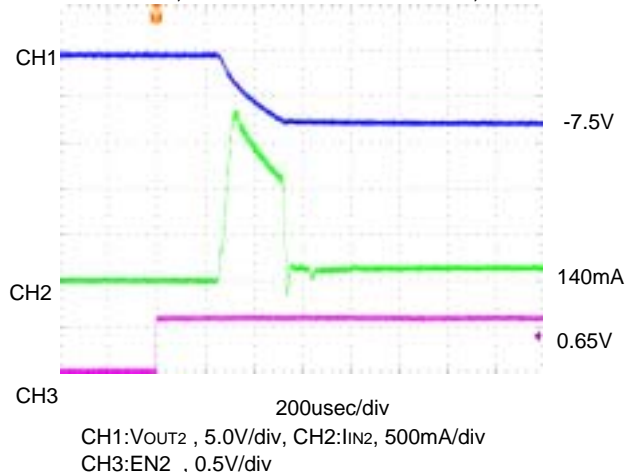

* EN1=GND