

### Typical Applications

The HMC143 & HMC144 is ideal for:

- Microwave Pt to Pt Radios
- VSAT

### Features

- Input IP3: +21 dBm
- LO / RF Isolation: 30 dB
- IF Bandwidth: DC to 3 GHz
- Small Size: 1.48mm x 2.06mm

### Functional Diagram

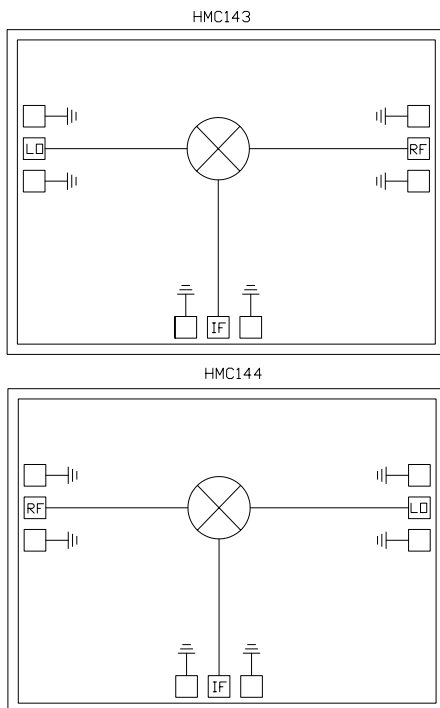

### General Description

The HMC143 chip is a miniature double-balanced mixer which can be used as an upconverter or downconverter. The chip utilizes a standard 1um GaAs MESFET process. The HMC144 is identical to the HMC143 except that the layout is a mirror image designed to ease integration into image-reject mixer modules. Broadband operation and excellent isolations are provided by on-chip baluns, which require no external components and no DC bias. The design is similar to the HMC141/142 mixers but with an IF combiner in a double-balanced design, providing improved RF/IF isolation. These devices are much smaller and more reliable replacements to hybrid diode mixers.

### Electrical Specifications, $T_A = +25^\circ C$ , LO Drive = +20 dBm

Parameter	Min.	Typ.	Max.	Units
Frequency Range, RF & LO	5 - 20			GHz
Frequency Range, IF	DC - 3			GHz
Conversion Loss		10	12	dB
Noise Figure (SSB)		10	12	dB
LO to RF Isolation	28	30		dB
LO to IF Isolation	14	16		dB
IP3 (Input)	16	21		dBm
IP2 (Input)	42	51		dBm
1 dB Gain Compression (Input)	5	10		dBm

## GaAs MMIC DOUBLE-BALANCED MIXER, 5 - 20 GHz

**Conversion Loss**

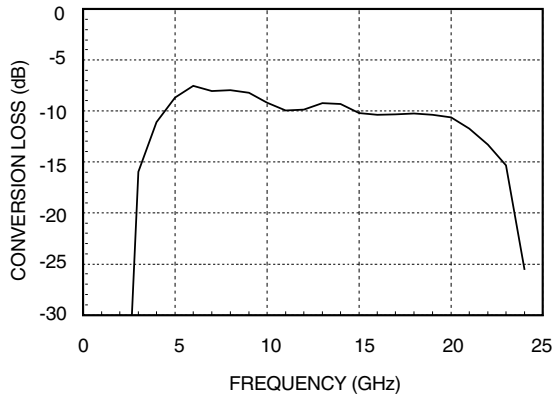

**Isolation**

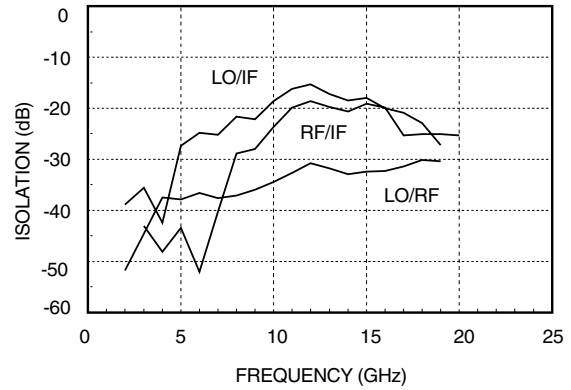

**Conversion Loss vs. LO Drive Level @ Several RF Frequencies**

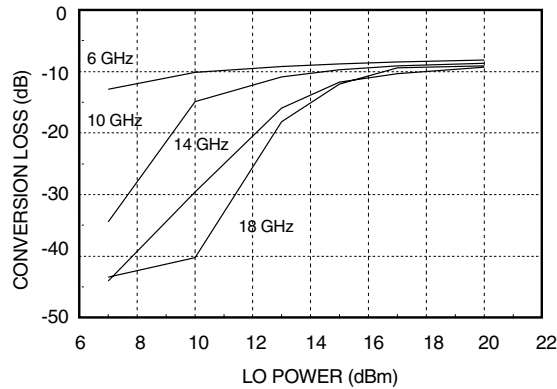

**Upconverter Performance**

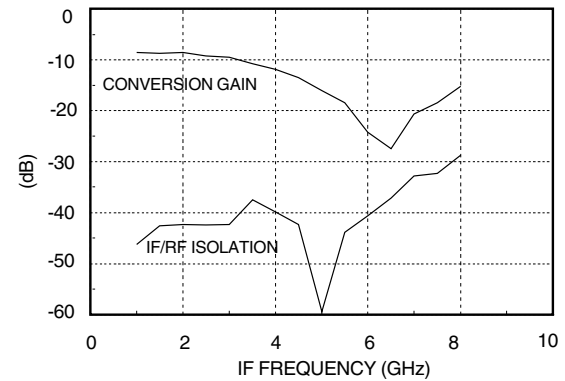

Input at IF Port (1-8 GHz); Output at LO Port (9 GHz)  
Local Oscillator at RF Port (10-17 GHz)

**RF Return Loss**

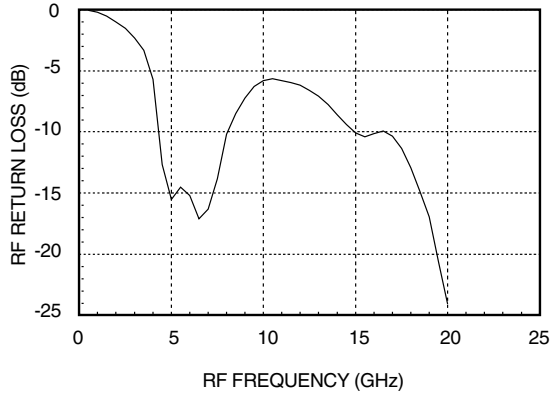

**LO Return Loss**

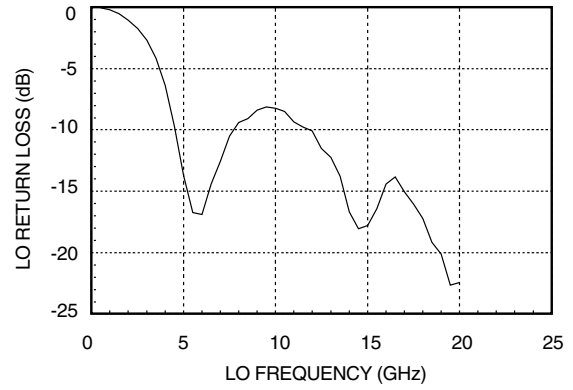

**IF Return Loss**

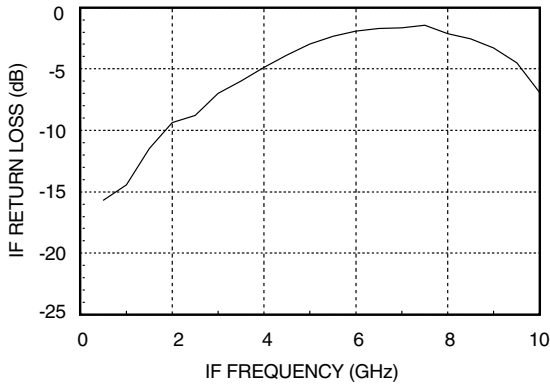

**Absolute Maximum Ratings**

LO Drive	+27 dBm
Storage Temperature	-65 to +150 °C
Operating Temperature	-55 to +85 °C

**Outline Drawings** (See HMC143/144 Operation Application Note in Section 15)

### HMC143

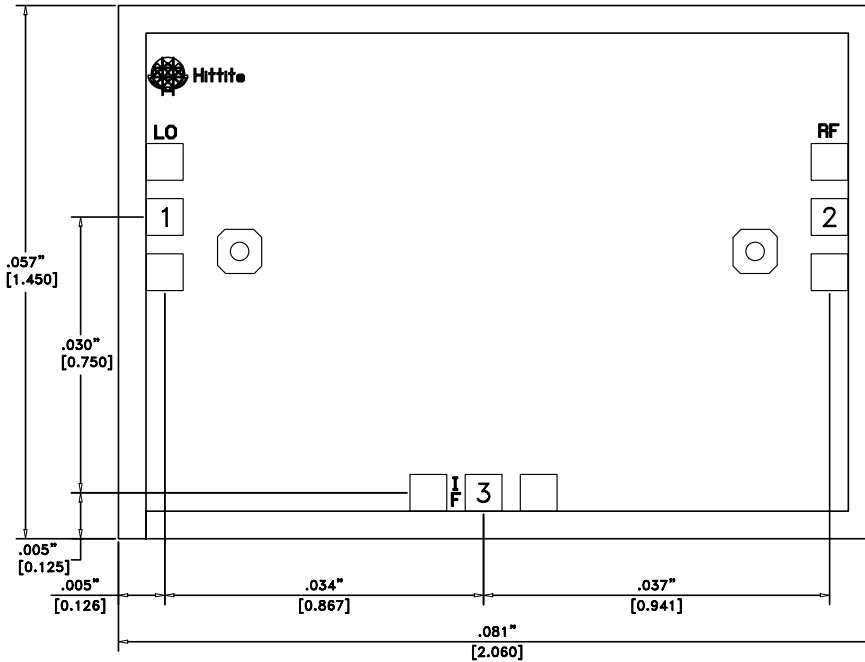

**NOTES:**

1. ALL DIMENSIONS ARE IN INCHES [MM].
2. DIE THICKNESS IS .004".
3. TYPICAL BOND PAD IS .004" SQUARE.
4. BACKSIDE METALLIZATION: GOLD.
5. BOND PAD METALLIZATION: GOLD.
6. BACKSIDE METAL IS GROUND.
7. CONNECTION NOT REQUIRED FOR UNLABELED BOND PADS.

### HMC144

