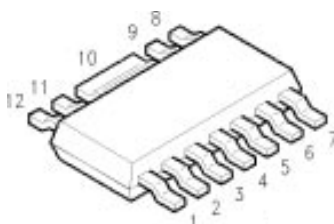

Datasheet

<p>*Power amplifier for GSM or AMPS application *Fully integrated 2 stage amplifier *Operating voltage range: 2.7 to 6 V *Overall power added efficiency 45 % *Input matched to 50 ohms, simple output match</p> <p>ESD: ElectroStatic discharge sensitive device, observe handling precautions!</p>	
--	---

Type	Marking	Ordering code (taped)	Package ¹⁾
CGY 92	CGY 92	Q68000-A8884	MW 12

Maximum ratings

Characteristics	Symbol	max. Value	Unit
Positive supply voltage	V_D	9	V
Negative supply voltage	V_G	-6	V
Supply current	I_D	2	A
Channel temperature	T_{Ch}	150	°C
Storage temperature	T_{stg}	-55...+150	°C
RF input power	P_{in}	25	dBm
Pulse peak power dissipation <i>duty cycle 12.5%, $t_{on}=0.577ms$</i>	P_{Pulse}	9	W
Total power dissipation (CW, $T_s \leq 81^\circ C$) <i>T_s: Temperature at soldering point</i>	P_{tot}	5	W

Thermal Resistance

Channel-soldering point	R_{thChS}	≤ 14	K/W
-------------------------	-------------	-----------	-----

1) Plastic body identical to SOT 223, dimensions see page 14

Functional block diagramm:

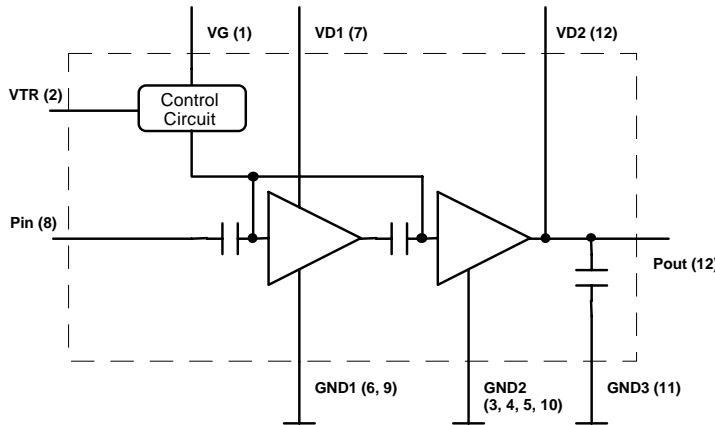

Control circuit:

The drain current I_D of the CGY 92 is adjusted by the internal control circuit. Therefore a negativ voltage (-4V...-6V) has to be supplied at VG. For transmit operation VTR must be set to 0V. During receive operation VTR should be disconnected (shut off mode).

Pin #		Configuration
1	VG	Negative voltage at control circuit (-4V...-6V)
2	VTR	Control voltage for transmit mode (0V) or receive mode (open)
3,4,5,10	GND 2	RF and DC ground of the 2nd stage
6,9	GND 1	RF and DC ground of the 1st stage
7	VD1	Positive drain voltage of the 1st stage
8	RFin	RF input power
11	GND 3	Ground for internal output matching
12	VD2, RFout	Positive drain voltage of the 2nd stage, RF output power

DC characteristics

Characteristics	Symbol	Conditions	min	typ	max	Unit
Drain current stage 1	$IDSS1$	VD=3V, VG=0V, VTR n.c.	0.6	0.9	1.2	A
	stage 2		$IDSS2$	2.4	3.5	4.8
Drain current with active current control	ID	VD=3V, VG=-4V, VTR=0V	-	1.0	-	A
Transconductance (stage 1 and 2)	$gfs1$	VD=3V, ID=350mA	0.28	0.32	-	S
	$gfs2$	VD=3V, ID=700mA	1.1	1.3	-	S
Pinch off voltage	Vp	VD=3V, ID<500μA (all stages)	-3.8	-2.8	-1.8	V

Electrical characteristics

($T_A = 25^\circ\text{C}$, $f=0.9\text{ GHz}$, $Z_S=Z_L=50\text{ Ohm}$, $V_D=3.0\text{V}$, $V_G=-4\text{V}$, VTR pin connected to ground, unless otherwise specified, pulsed with a duty cycle of 10%, $t_{on}=0.33\text{ms}$)

Characteristics	Symbol	min	typ	max	Unit
Supply current <i>P_{in}=10dBm</i>	I_{DD}	-	1.05	-	A
Negative supply current <i>(normal operation)</i>	I_G	-	2	-	mA
Shut-off current <i>VTR n.c.</i>	I_D	-	400	-	μA
Negative supply current <i>(shut off mode, VTR pin n.c.)</i>	I_G	-	10	-	μA
Small signal gain <i>P_{in} = -5dBm</i>	G	27.0	29.0	-	dB
Power gain <i>V_D=3V; P_{in}=10dBm</i>	G	21.0	21.8	-	dB
Output Power <i>V_D=3V; P_{in}=10dBm</i>	P_O	31.0	31.8	-	dBm
Output Power <i>V_D=3.6V; P_{in}=10dBm</i>	P_O	32.3	33.1	-	dBm
Output Power <i>V_D=5V; P_{in}=10dBm</i>	P_O	34.0	35.0	-	dBm
Overall Power added Efficiency <i>V_D=3V; P_{in}=10dBm</i>	η	43	48	-	%
Overall Power added Efficiency <i>V_D=3.6V; P_{in}=10dBm</i>	η	41	46	-	%
Overall Power added Efficiency <i>V_D=5V; P_{in}=10dBm</i>	η	40	45	-	%
Harmonics (<i>P_{in}=10dBm</i>) <i>V_D=3V; (P_{out}=32dBm)</i>	$2f_0$	-	-	-46	dBc
	$3f_0$	-	-	-37	dBc
Harmonics (<i>P_{in}=10dBm</i>) <i>V_D=5V; (P_{out}=35dBm)</i>	$2f_0$	-	-	-48	dBc
	$3f_0$	-	-	-38	dBc
Input VSWR <i>V_D=3.0V;</i>	-	-	1.7 : 1	2.0 : 1	-
Third order intercept point <i>V_D=3V; pulsed with a duty cycle of 10%;</i> <i>f₁=900.00MHz; f₂=900.20MHz;</i>	IP_3	-	40	-	dBm
Third order intercept point <i>V_D=4.8V; pulsed with a duty cycle of 10%;</i> <i>f₁=900.00MHz; f₂=900.20MHz;</i>	IP_3	-	45	-	dBm

DC-ID(VG) characteristics - typical values of stage 1, VD=3V

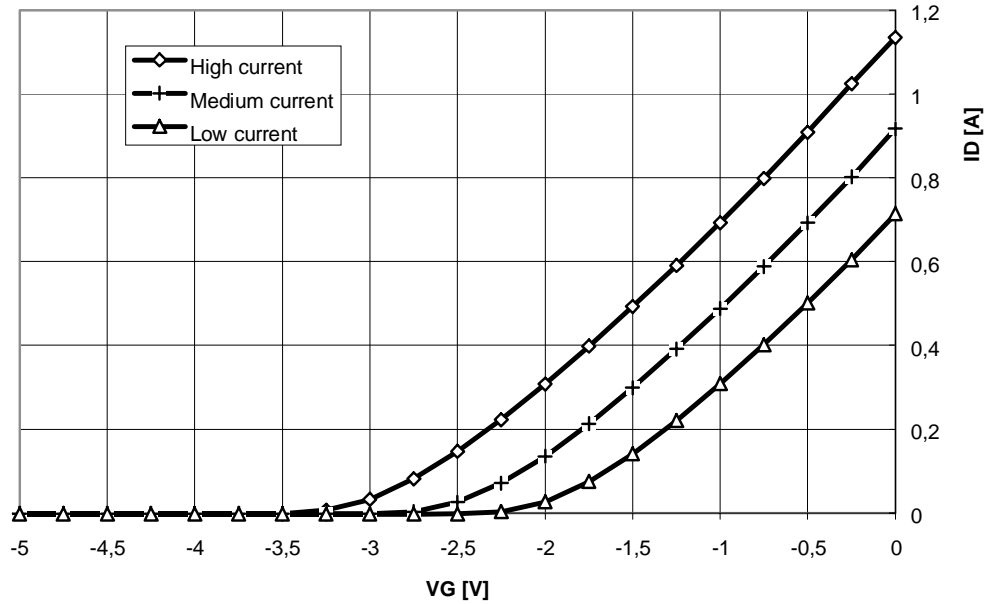

DC-Output characteristics - typical values of stage 1

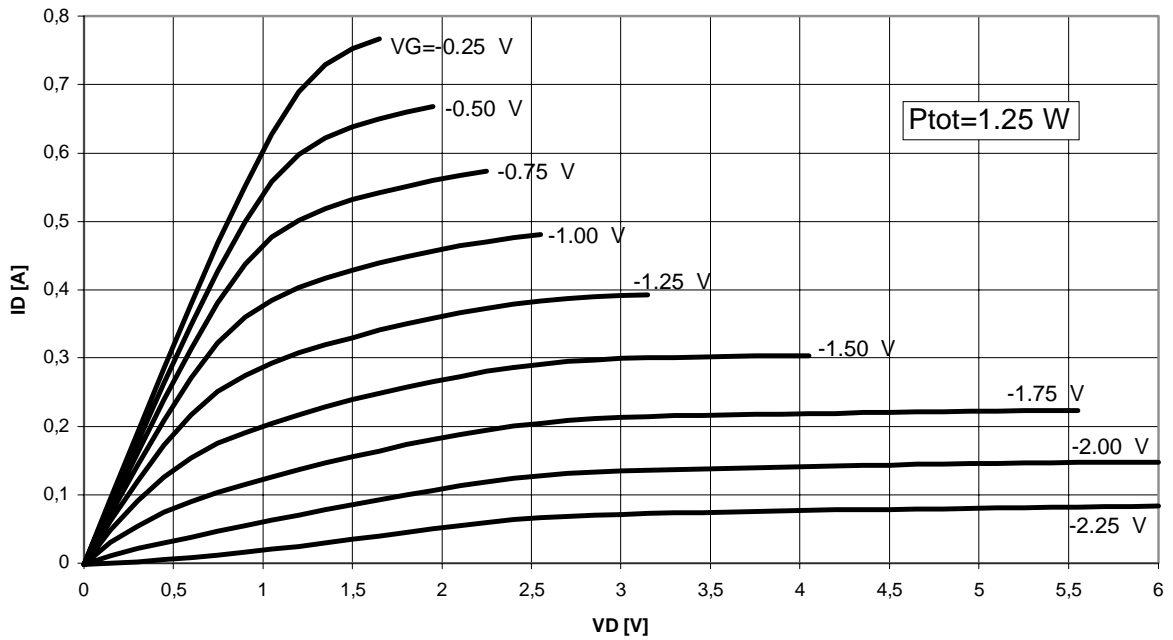

DC-ID(VG) characteristics - typical values of stage 2, VD=3V

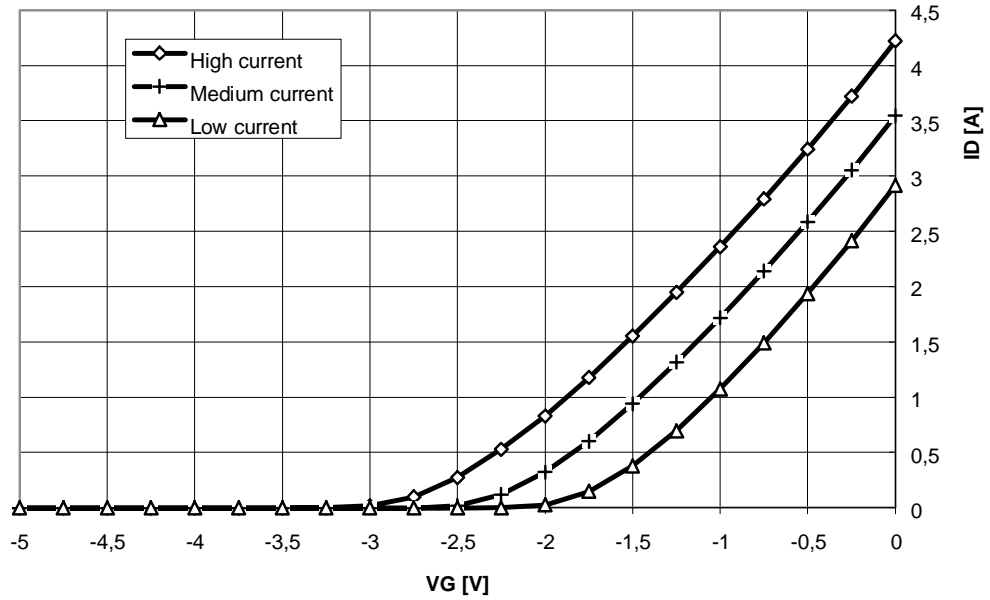

DC-Output characteristics - typical values of stage 2

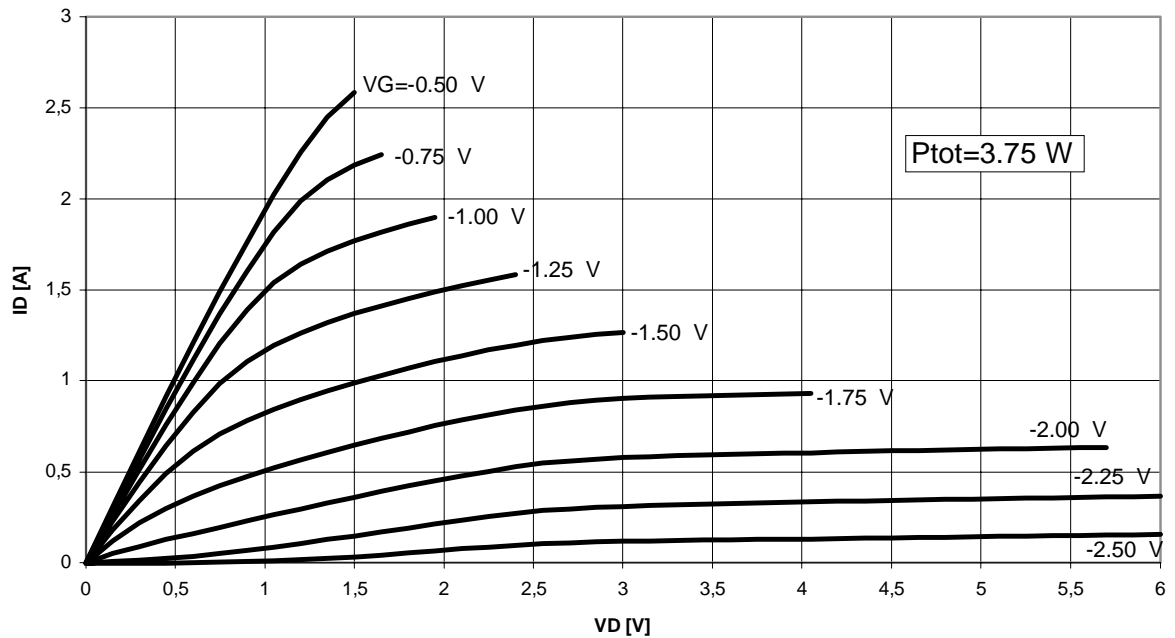

Pout and PAE vs. Pin

(VD=3V, VG=-4V, VTR=0V, f=900MHz, pulsed with a duty cycle of 10%, ton=0.33ms)

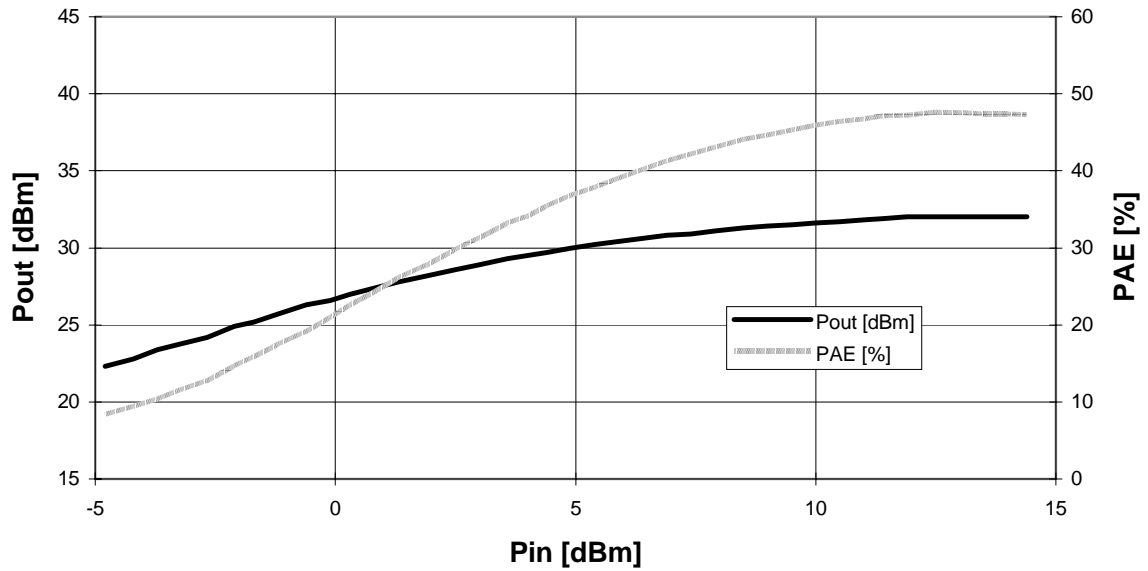

Pout and PAE vs. Pin

(VD=5V, VG=-4V, VTR=0V, f=900MHz, pulsed with a duty cycle of 10%, ton=0.33ms)

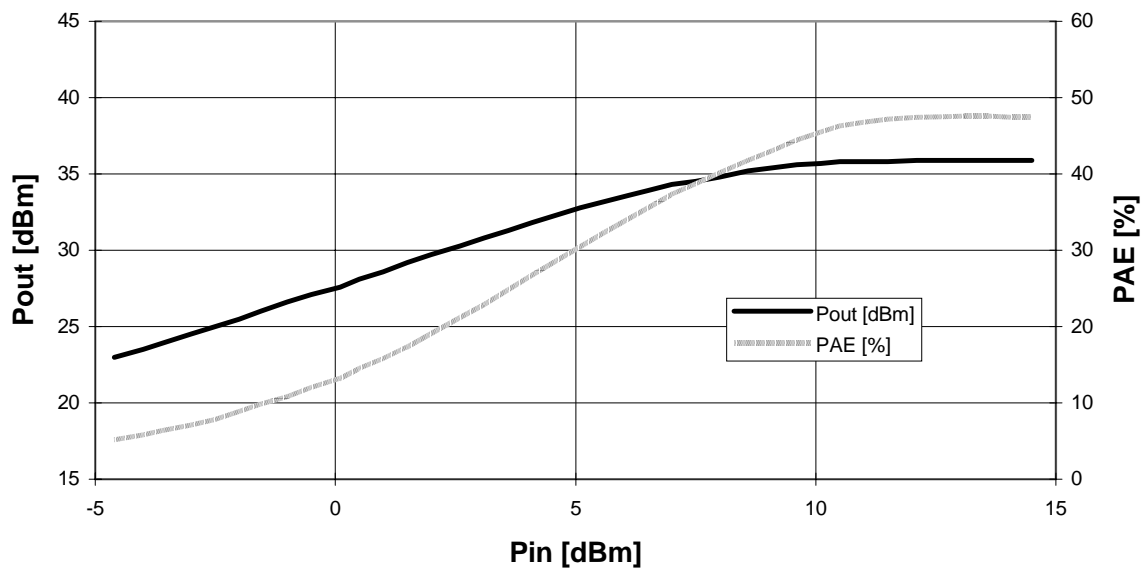

Output power at different temperatures

(VD=3V, VG=-4V, VTR=0V, f=900MHz, pulsed with a duty cycle of 10%, ton=0.33ms)

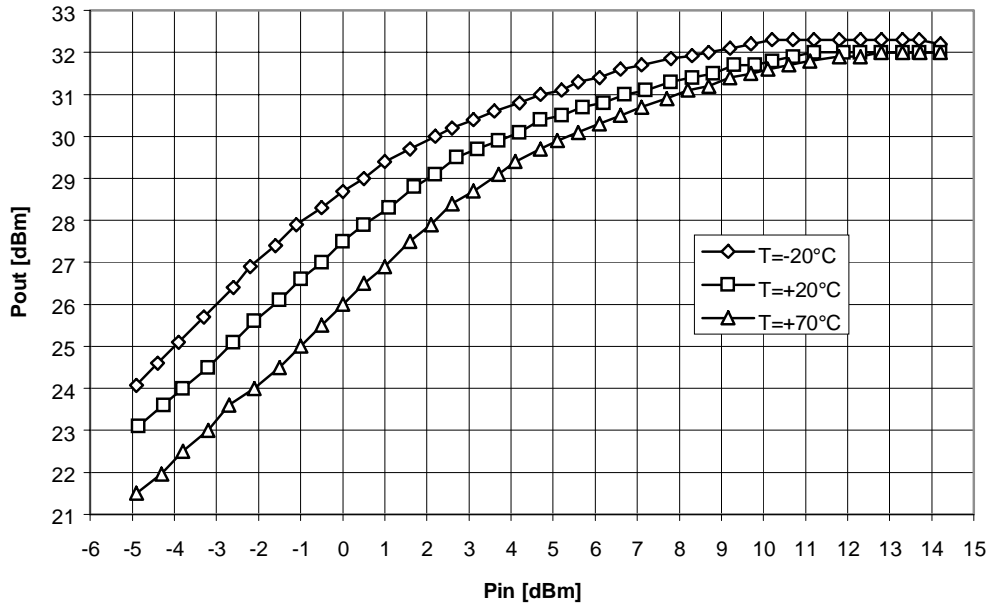

Power added efficiency at different temperatures

(VD=3V, VG=-4V, VTR=0V, f=900MHz, pulsed with a duty cycle of 10%, ton=0.33ms)

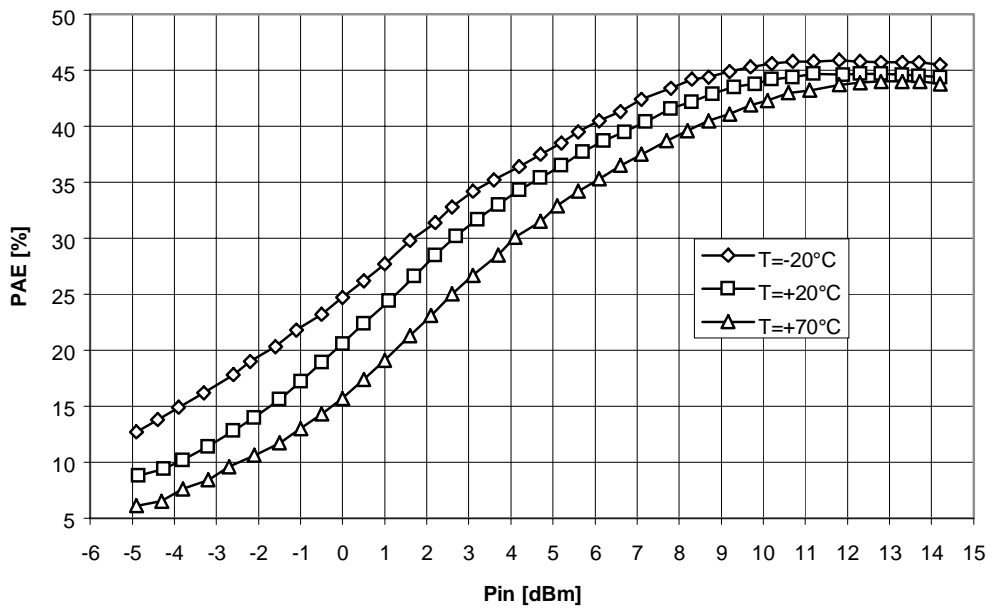

Measured S-parameter at VD=3V and Pin=9dBm

(VG=-4V, VTR=0V, pulsed with a duty cycle of 10%, ton=0.33ms)

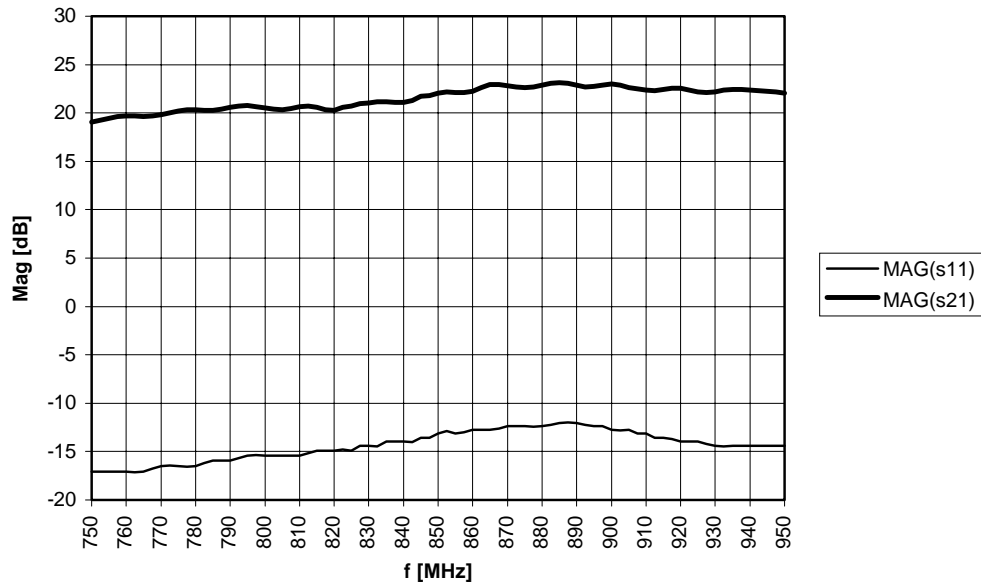

Measured S-parameter at VD=5V and Pin=9dBm

(VG=-4V, VTR=0V, pulsed with a duty cycle of 10%, ton=0.33ms)

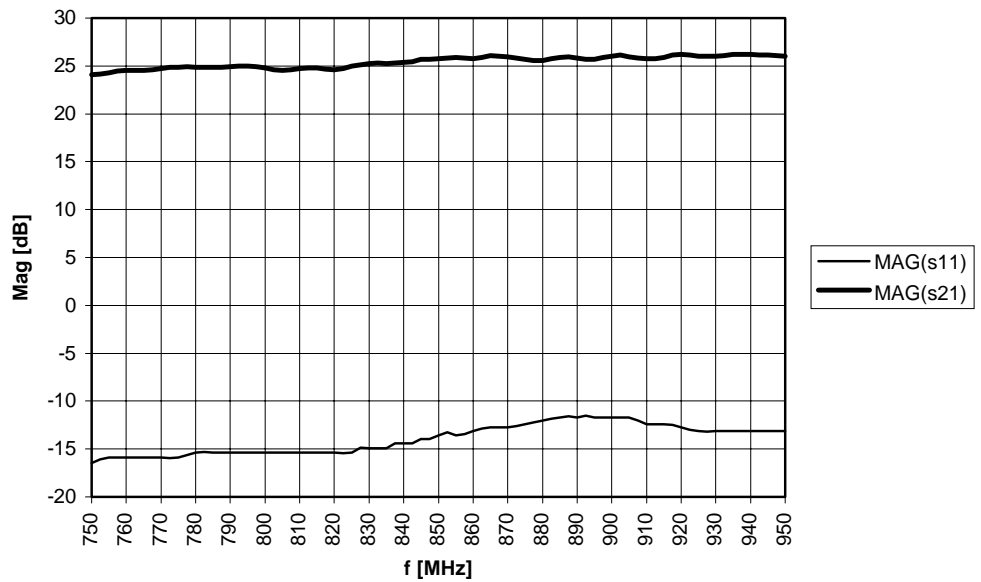

Output power vs. drain voltage

(Pin=10dBm, VG=-4V, VTR=0V, f=900MHz, pulsed with a duty cycle of 10%, ton=0.33ms)

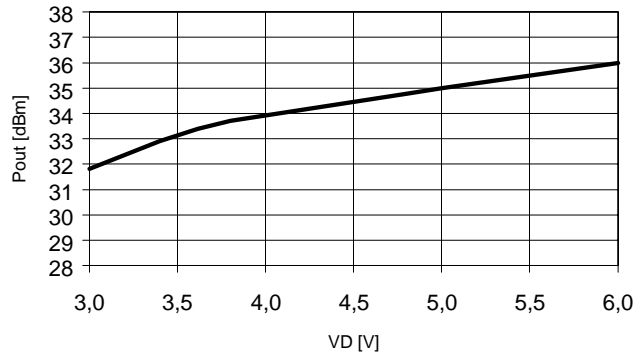

Performance of internal bias control circuit @VD=3V

(VTR=0V, pulsed with a duty cycle of 10%, ton=0.33ms)

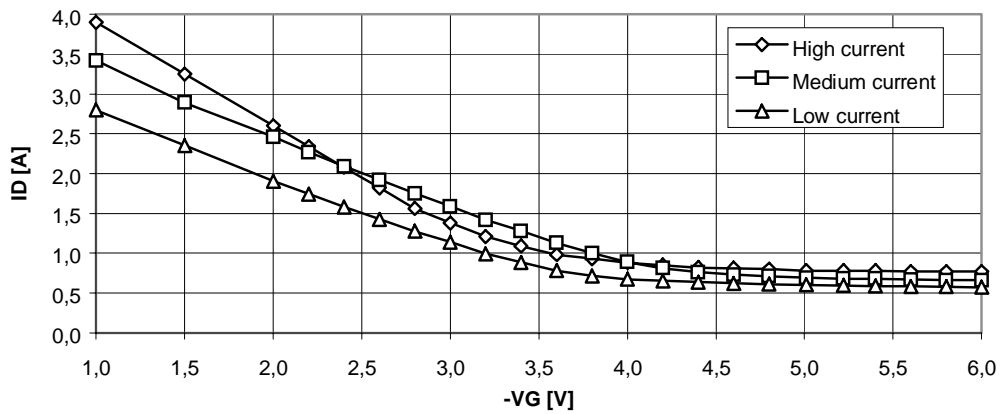

Performance of internal bias control circuit @VD=5V

(VTR=0V, pulsed with a duty cycle of 10%, ton=0.33ms)

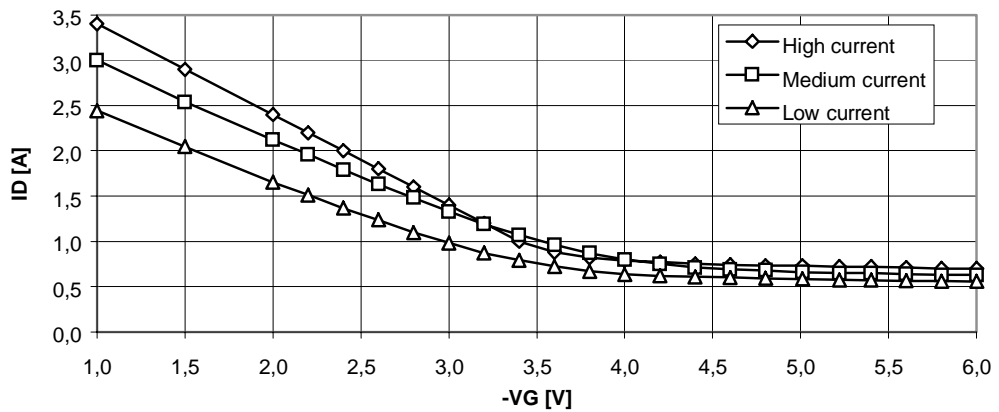

Total Power Dissipation $P_{tot}=f(T_s)$

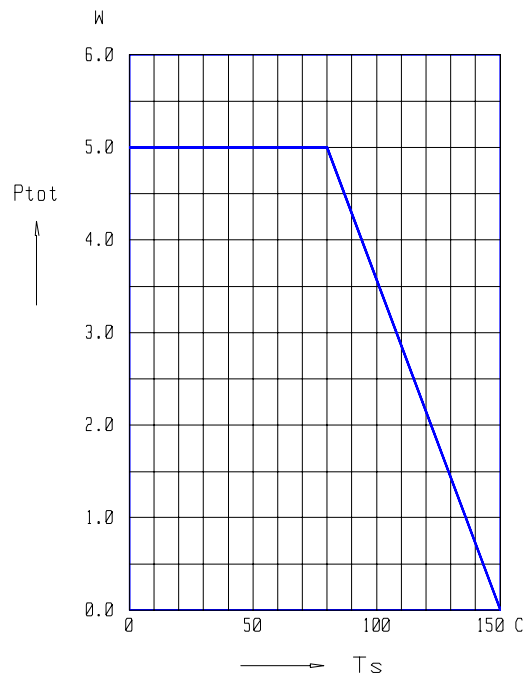

Permissible pulse load $P_{tot_max}/P_{tot_DC} = f(t_p)$

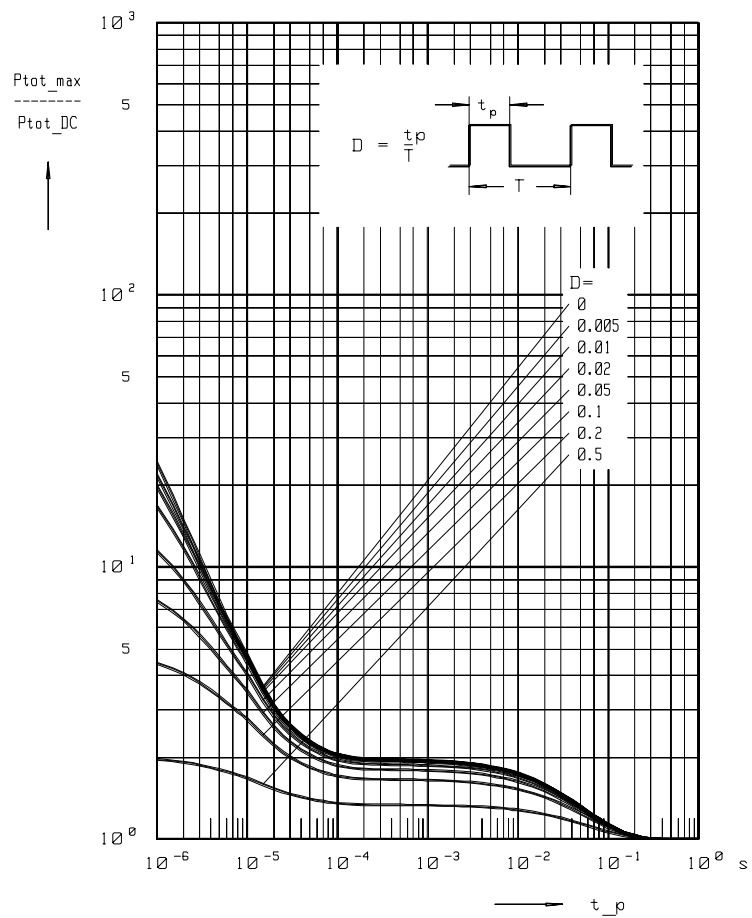

Test circuit board:

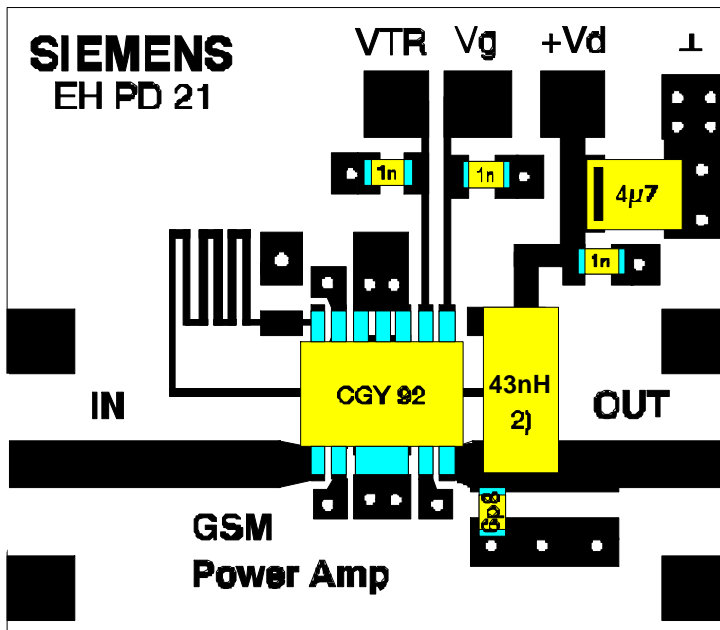

size: 30 x 26 mm

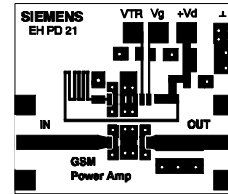

Note:

By changing the position of the 6.8 pF capacitor at pin # 12 it is possible to tune the board for max. Pout or max. PAE. To achieve the maximum output power place the capacitor close to the CGY92. For a better PAE increase the distance between the capacitor and the CGY92 device (2-5mm).

Principal circuit:

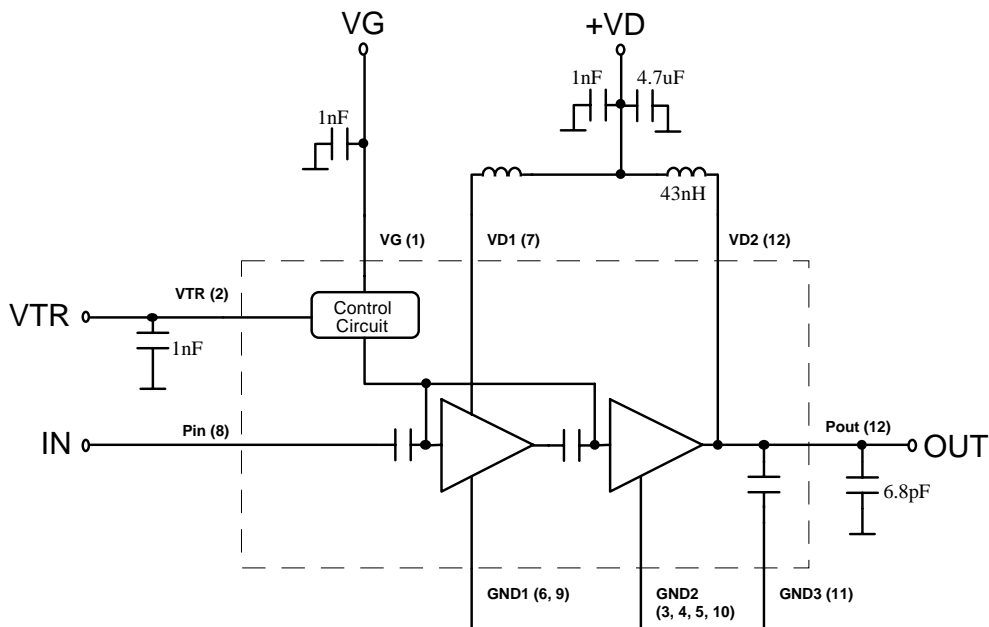

2) Coilcraft SMD Spring Inductor
distribution by Ginsbury Electronic GmbH, Am Moosfeld 85 D-81829 München, Tel. 089/45170-223

Emissions due to GMSK modulation:

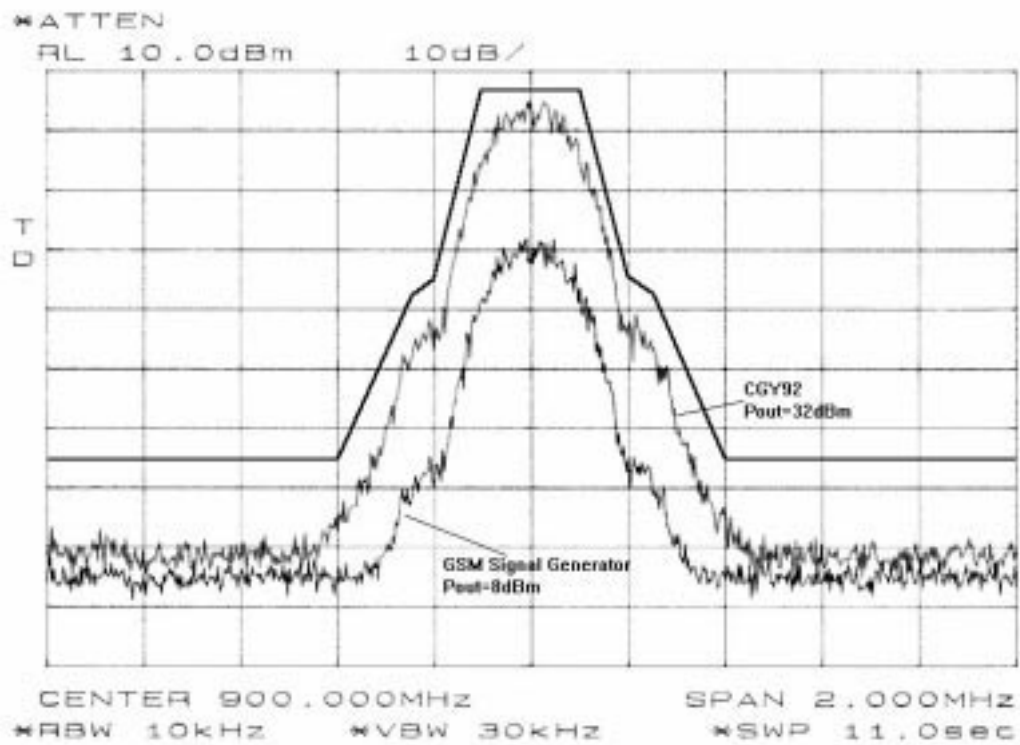

Measurement was done with the following equipment:

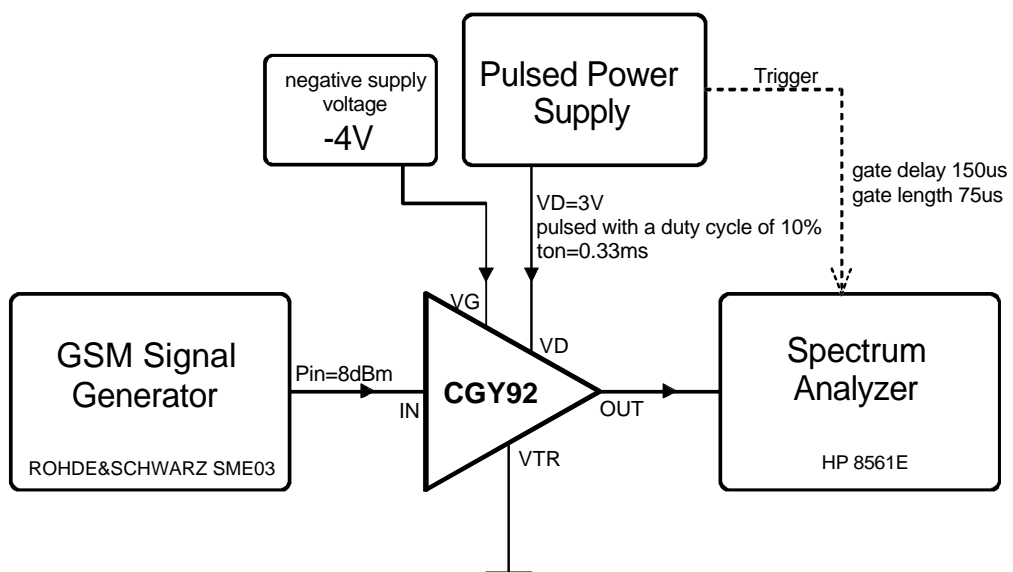

APPLICATION - HINTS

1. CW - capability of the CGY92

Proving the possibility of CW - operation there must be known the total power dissipation of the device. This value can be found as a function of the temperature in the datasheet (page 10). The CGY92 has a maximum total power dissipation of $P_{tot} = 5 \text{ W}$.

As an example we take the operating point with a drain voltage $V_D = 3 \text{ V}$ and a typical drain current of $I_D = 1.0 \text{ A}$. So the maximum DC - power can be calculated to:

$$P_{DC} = V_D \cdot I_D = 3 \text{ W}$$

This value is smaller than 5 W and CW - operation is possible.

By decoupling RF power out of the CGY92 the power dissipation of the device can be further reduced. Assuming a power added efficiency (PAE) of 40 % the total power dissipation P_{tot} can be calculated using the following formula:

$$P_{tot} = P_{DC} (1 - PAE) = 3 \text{ W} (1 - 0.40) = 1.8 \text{ W}$$

2. Operation without using the internal current control

If you don't want to use the internal current control, it is recommended to connect the negative supply voltage at pin 1 (V_{TR}) instead of pin 2 (V_G). In that case V_G is not connected.

3. Biasing and use considerations

Biasing should be timed such that gate voltage (V_G) is always applied before the drain voltage (V_D), and when returning to the standby mode, gate voltage should only be removed once the drain voltage have been removed.

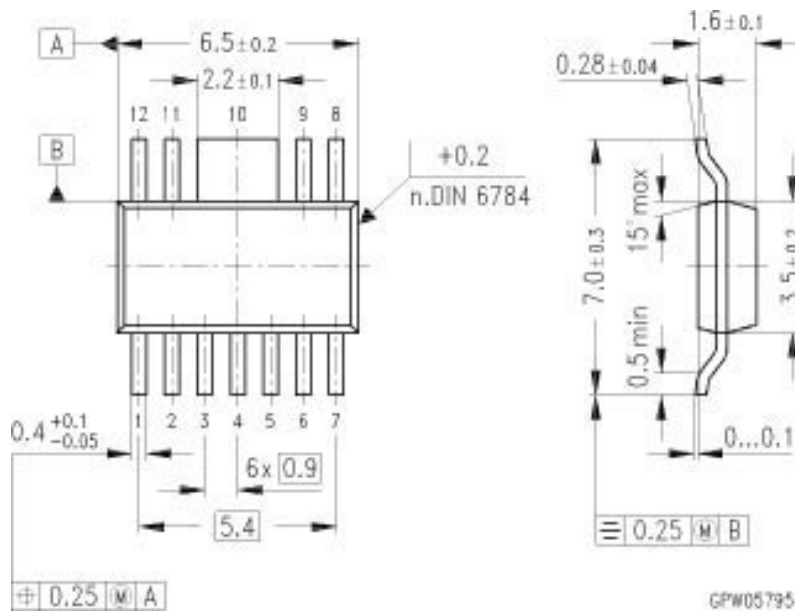

Published by Siemens AG, Bereich Bauelemente, Vertrieb, Produkt-Information, Balanstraße 73, D-81541 München

© Siemens AG 1995. All Rights Reserved

As far as patents or other rights of third parties are concerned, liability is only assumed for components per se, not for applications, processes and circuits implemented within components or assemblies.

The information describes the type of component and shall not be considered as assured characteristics.

Terms of delivery and rights to change design reserved.

For questions on technology, delivery and prices please contact the Offices of Semiconductor Group in Germany or the Siemens Companies and Representatives world-wide (see address list).

Due to technical requirements components may contain dangerous substances. For information on the type in question please contact your nearest Siemens Office, Semiconductor Group.

Siemens AG is an approved CECC manufacturer.