

ADG741/ADG742

FEATURES

1.8 V to 5.5 V Single Supply
2 Ω (Typ) On Resistance
Low On-Resistance Flatness
-3 dB Bandwidth >200 MHz
Rail-to-Rail Operation
6-Lead SC70
Fast Switching Times
 t_{ON} 18 ns
 t_{OFF} 12 ns
Typical Power Consumption (<0.01 μ W)
TTL/CMOS Compatible

APPLICATIONS

Battery Powered Systems
Communication Systems
Sample Hold Systems
Audio Signal Routing
Video Switching
Mechanical Reed Relay Replacement

GENERAL DESCRIPTION

The ADG741/ADG742 are monolithic CMOS SPST switches. These switches are designed on an advanced submicron process that provides low power dissipation yet high switching speed, low on resistance, low leakage currents and -3 dB bandwidths of greater than 200 MHz can be achieved.

The ADG741/ADG742 can operate from a single 1.8 V to 5.5 V supply, making it ideal for use in battery-powered instruments and with Analog Devices' new generation of DACs and ADCs.

As can be seen from the Functional Block Diagrams, with a logic input of "1" the switch of the ADG741 is closed, while that of the ADG742 is open. Each switch conducts equally well in both directions when ON.

The ADG741/ADG742 are available in 6-lead SC70 package.

FUNCTIONAL BLOCK DIAGRAMS

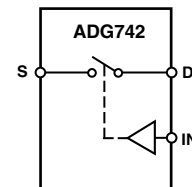
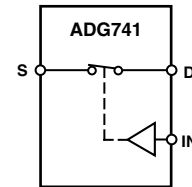

SWITCHES SHOWN FOR
A LOGIC "1" INPUT

PRODUCT HIGHLIGHTS

1. 1.8 V to 5.5 V Single Supply Operation. The ADG741/ADG742 offer high performance, including low on resistance and fast switching times and is fully specified and guaranteed with 3 V and 5 V supply rails.
2. Very Low R_{ON} (3 Ω max at 5 V, 5 Ω max at 3 V). At 1.8 V operation, R_{ON} is typically 40 Ω over the temperature range.
3. On-Resistance Flatness $R_{FLAT(ON)}$ (1 Ω max).
4. -3 dB Bandwidth >200 MHz.
5. Low Power Dissipation. CMOS construction ensures low power dissipation.
6. Fast t_{ON}/t_{OFF} .
7. Tiny 6-Lead SC70 package.

REV. 0

Information furnished by Analog Devices is believed to be accurate and reliable. However, no responsibility is assumed by Analog Devices for its use, nor for any infringements of patents or other rights of third parties which may result from its use. No license is granted by implication or otherwise under any patent or patent rights of Analog Devices.

ADG741/ADG742—SPECIFICATIONS¹ ($V_{DD} = 5\text{ V} \pm 10\%$, $GND = 0\text{ V}$. All specifications -40°C to $+85^{\circ}\text{C}$ unless otherwise noted.)

Parameter	B Version		Unit	Test Conditions/Comments
	25°C	-40°C to +85°C		
ANALOG SWITCH				
Analog Signal Range		0 V to V_{DD}	V	
On Resistance (R_{ON})	2		Ω typ	$V_S = 0\text{ V}$ to V_{DD} , $I_S = -10\text{ mA}$; Test Circuit 1
	3	4	Ω max	
On-Resistance Flatness ($R_{FLAT(ON)}$)	0.5	1.0	Ω typ Ω max	$V_S = 0\text{ V}$ to V_{DD} , $I_S = -10\text{ mA}$
LEAKAGE CURRENTS²				
Source OFF Leakage I_S (OFF)	± 0.01		nA typ	$V_{DD} = 5.5\text{ V}$ $V_S = 4.5\text{ V}/1\text{ V}$, $V_D = 1\text{ V}/4.5\text{ V}$; Test Circuit 2
	± 0.25	± 0.35	nA max	
Drain OFF Leakage I_D (OFF)	± 0.01		nA typ	$V_S = 4.5\text{ V}/1\text{ V}$, $V_D = 1\text{ V}/4.5\text{ V}$; Test Circuit 2
	± 0.25	± 0.35	nA max	
Channel ON Leakage I_D , I_S (ON)	± 0.01		nA typ	$V_S = V_D = 1\text{ V}$, or 4.5 V ; Test Circuit 3
	± 0.25	± 0.35	nA max	
DIGITAL INPUTS				
Input High Voltage, V_{INH}		2.4	V min	
Input Low Voltage, V_{INL}		0.8	V max	
Input Current I_{INL} or I_{INH}	0.005		μA typ μA max	$V_{IN} = V_{INL}$ or V_{INH}
		± 0.1		
DYNAMIC CHARACTERISTICS²				
t_{ON}	12		ns typ ns max	$R_L = 300\ \Omega$, $C_L = 35\text{ pF}$ $V_S = 3\text{ V}$; Test Circuit 4
		18		
t_{OFF}	8		ns typ ns max	$R_L = 300\ \Omega$, $C_L = 35\text{ pF}$ $V_S = 3\text{ V}$; Test Circuit 4
		12		
Charge Injection	5		pC typ	$V_S = 2\text{ V}$, $R_S = 0\ \Omega$, $C_L = 1\text{ nF}$; Test Circuit 5
Off Isolation	-55 -75		dB typ dB typ	$R_L = 50\ \Omega$, $C_L = 5\text{ pF}$, $f = 10\text{ MHz}$ $R_L = 50\ \Omega$, $C_L = 5\text{ pF}$, $f = 1\text{ MHz}$; Test Circuit 6
Bandwidth -3 dB	200		MHz typ	$R_L = 50\ \Omega$, $C_L = 5\text{ pF}$; Test Circuit 7
C_S (OFF)	17		pF typ	
C_D (OFF)	17		pF typ	
C_D , C_S (ON)	38		pF typ	
POWER REQUIREMENTS				
I_{DD}	0.001		μA typ μA max	$V_{DD} = 5.5\text{ V}$ Digital Inputs = 0 V or 5 V
		1.0		

NOTES

¹Temperature ranges are as follows: B Versions: -40°C to $+85^{\circ}\text{C}$.

²Guaranteed by design, not subject to production test.

Specifications subject to change without notice.

SPECIFICATIONS¹ ($V_{DD} = 3\text{ V} \pm 10\%$, $GND = 0\text{ V}$. All specifications -40°C to $+85^\circ\text{C}$ unless otherwise noted.)

Parameter	B Version		Unit	Test Conditions/Comments
	25°C	-40°C to +85°C		
ANALOG SWITCH				
Analog Signal Range		0 V to V_{DD}	V	
On Resistance (R_{ON})	3.5		Ω typ	$V_S = 0\text{ V}$ to V_{DD} , $I_S = -10\text{ mA}$; Test Circuit 1
	5	6	Ω max	
On-Resistance Flatness ($R_{FLAT(ON)}$)	1.5		Ω typ	$V_S = 0\text{ V}$ to V_{DD} , $I_S = -10\text{ mA}$
LEAKAGE CURRENTS²				
Source OFF Leakage I_S (OFF)	± 0.01		nA typ	$V_{DD} = 3.3\text{ V}$ $V_S = 3\text{ V}/1\text{ V}$, $V_D = 1\text{ V}/3\text{ V}$; Test Circuit 2
	± 0.25	± 0.35	nA max	
Drain OFF Leakage I_D (OFF)	± 0.01		nA typ	$V_S = 3\text{ V}/1\text{ V}$, $V_D = 1\text{ V}/3\text{ V}$; Test Circuit 2
	± 0.25	± 0.35	nA max	
Channel ON Leakage I_D , I_S (ON)	± 0.01		nA typ	$V_S = V_D = 1\text{ V}$, or 3 V ; Test Circuit 3
	± 0.25	± 0.35	nA max	
DIGITAL INPUTS				
Input High Voltage, V_{INH}		2.0	V min	
Input Low Voltage, V_{INL}		0.4	V max	
Input Current I_{INL} or I_{INH}	0.005		μA typ	$V_{IN} = V_{INL}$ or V_{INH}
		± 0.1	μA max	
DYNAMIC CHARACTERISTICS²				
t_{ON}	14		ns typ	$R_L = 300\ \Omega$, $C_L = 35\text{ pF}$ $V_S = 2\text{ V}$, Test Circuit 4
		20	ns max	
t_{OFF}	8		ns typ	$R_L = 300\ \Omega$, $C_L = 35\text{ pF}$ $V_S = 2\text{ V}$, Test Circuit 4
		13	ns max	
Charge Injection	4		pC typ	$V_S = 1.5\text{ V}$, $R_S = 0\ \Omega$, $C_L = 1\text{ nF}$; Test Circuit 5
Off Isolation	-55		dB typ	$R_L = 50\ \Omega$, $C_L = 5\text{ pF}$, $f = 10\text{ MHz}$
	-75		dB typ	$R_L = 50\ \Omega$, $C_L = 5\text{ pF}$, $f = 1\text{ MHz}$; Test Circuit 6
Bandwidth -3 dB	200		MHz typ	$R_L = 50\ \Omega$, $C_L = 5\text{ pF}$; Test Circuit 7
C_S (OFF)	17		pF typ	
C_D (OFF)	17		pF typ	
C_D , C_S (ON)	38		pF typ	
POWER REQUIREMENTS				
I_{DD}	0.001		μA typ	$V_{DD} = 3.3\text{ V}$ Digital Inputs = 0 V or 3 V
		1.0	μA max	

NOTES¹Temperature ranges are as follows: B Versions: -40°C to $+85^\circ\text{C}$.²Guaranteed by design, not subject to production test.

Specifications subject to change without notice.

ADG741/ADG742

ABSOLUTE MAXIMUM RATINGS¹

(T_A = 25°C unless otherwise noted)

V _{DD} to GND	−0.3 V to +7 V
Analog, Digital Inputs ²	−0.3 V to V _{DD} +0.3 V or 30 mA, Whichever Occurs First
Continuous Current, S or D	30 mA
Peak Current, S or D	100 mA (Pulsed at 1 ms, 10% Duty Cycle Max)
Operating Temperature Range	
Industrial (B Version)	−40°C to +85°C
Storage Temperature Range	−65°C to +150°C
Junction Temperature	150°C
SC70 Package	
θ _{JA} Thermal Impedance	332°C/W
θ _{JC} Thermal Impedance	120°C/W
Lead Temperature, Soldering	
Vapor Phase (60 sec)	215°C
Infrared (15 sec)	220°C
ESD	1.5 kV

NOTES

¹Stresses above those listed under Absolute Maximum Ratings may cause permanent damage to the device. This is a stress rating only; functional operation of the device at these or any other conditions above those listed in the operational sections of this specification is not implied. Exposure to absolute maximum rating conditions for extended periods may affect device reliability. Only one absolute maximum rating may be applied at any one time.

²Overvoltages at IN, S or D will be clamped by internal diodes. Current should be limited to the maximum ratings given.

Table I. Truth Table

ADG741 In	ADG742 In	Switch Condition
0	1	OFF
1	0	ON

ORDERING GUIDE

Model	Temperature Range	Brand*	Package Description	Package Option
ADG741BKS	−40°C to +85°C	SFB	SC70	KS-6
ADG742BKS	−40°C to +85°C	SGB	SC70	KS-6

*Brand = Brand on these packages is limited to three characters due to space constraints.

CAUTION

ESD (electrostatic discharge) sensitive device. Electrostatic charges as high as 4000 V readily accumulate on the human body and test equipment and can discharge without detection. Although the ADG741/ADG742 features proprietary ESD protection circuitry, permanent damage may occur on devices subjected to high-energy electrostatic discharges. Therefore, proper ESD precautions are recommended to avoid performance degradation or loss of functionality.



PIN CONFIGURATIONS

6-Lead Plastic Surface Mount (SC70)

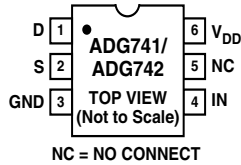

TERMINOLOGY

V_{DD}	Most Positive Power Supply Potential.
GND	Ground (0 V) Reference.
S	Source Terminal. May be an input or output.
D	Drain Terminal. May be an input or output.
IN	Logic Control Input.
R_{ON}	Ohmic Resistance Between D and S.
$R_{FLAT(ON)}$	Flatness is defined as the difference between the maximum and minimum value of on resistance as measured over the specified analog signal range.
I_S (OFF)	Source Leakage Current with the Switch "OFF."
I_D (OFF)	Drain Leakage Current with the Switch "OFF."
I_{D, I_S} (ON)	Channel Leakage Current with the Switch "ON."
V_D (V_S)	Analog Voltage on Terminals D, S.
C_S (OFF)	"OFF" Switch Source Capacitance.
C_D (OFF)	"OFF" Switch Drain Capacitance.
C_{D, C_S} (ON)	"ON" Switch Capacitance.
t_{ON}	Delay between applying the digital control input and the output switching on. See Test Circuit 4.
t_{OFF}	Delay between applying the digital control input and the output switching off.
Off Isolation	A measure of Unwanted Signal Coupling Through an "OFF" Switch.
Charge Injection	A measure of the glitch impulse transferred from the digital input to the analog output during switching.
Bandwidth	The frequency at which the output is attenuated by -3 dBs.
On Response	The frequency response of the "ON" switch.
On Loss	The voltage drop across the "ON" switch seen on the On Response vs. Frequency plot as how many dBs the signal is away from 0 dB at very low frequencies.

ADG741/ADG742—Typical Performance Characteristics

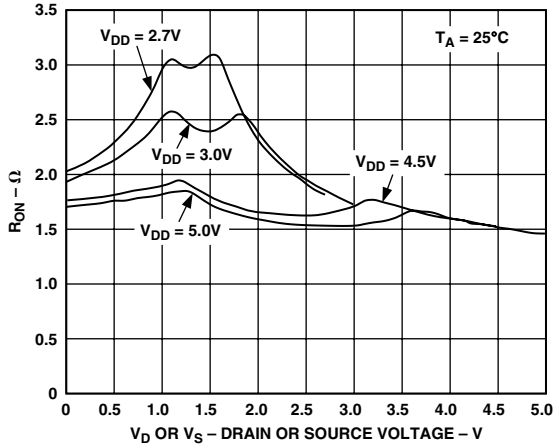

TPC 1. On Resistance as a Function of V_D (V_S) Single Supplies

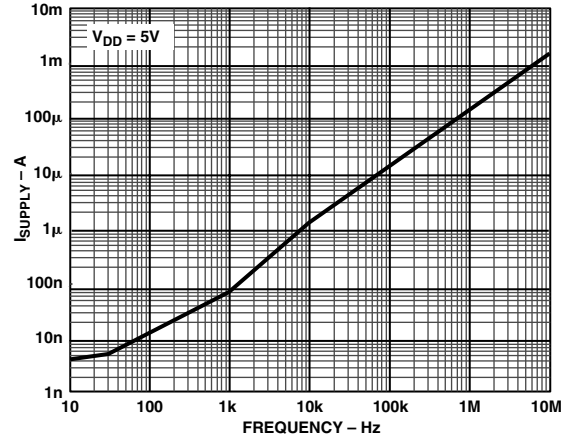

TPC 4. Supply Current vs. Input Switching Frequency

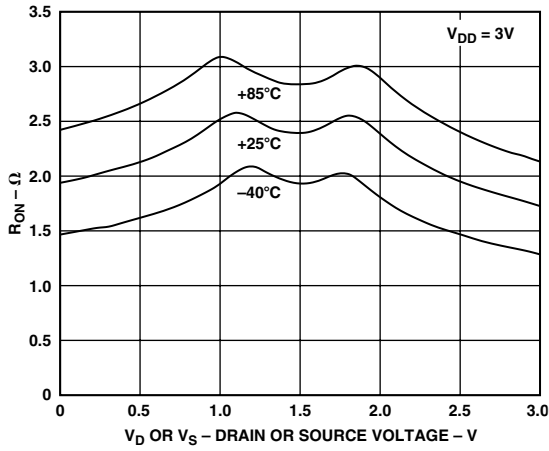

TPC 2. On Resistance as a Function of V_D (V_S) for Different Temperatures $V_{DD} = 3\text{V}$

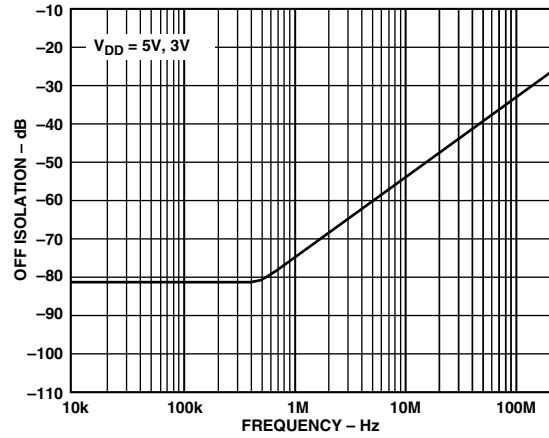

TPC 5. Off Isolation vs. Frequency

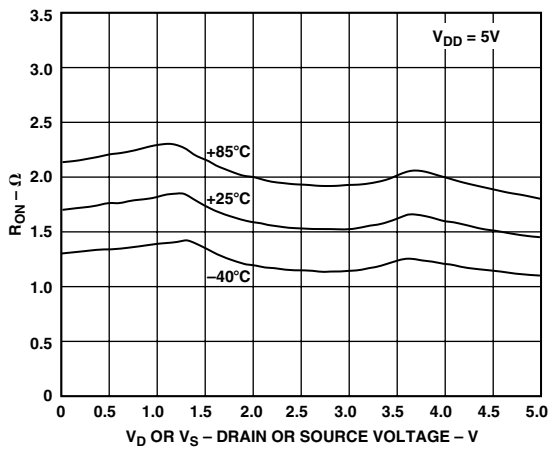

TPC 3. On Resistance as a Function of V_D (V_S) for Different Temperatures $V_{DD} = 5\text{V}$

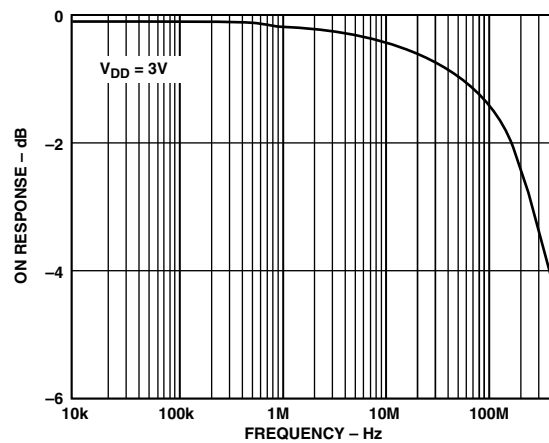

TPC 6. On Response vs. Frequency

Test Circuits

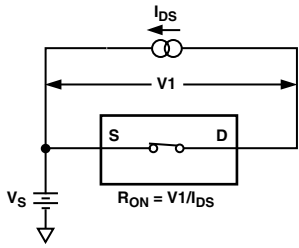

Test Circuit 1. On Resistance

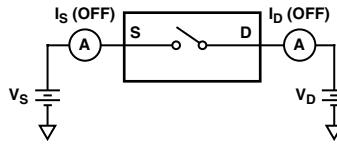

Test Circuit 2. Off Leakage

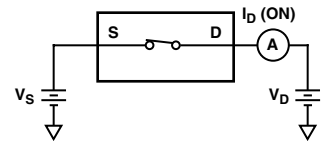

Test Circuit 3. On Leakage

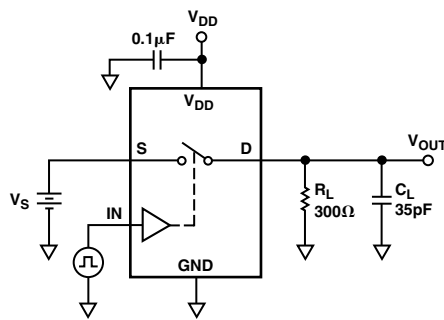

Test Circuit 4. Switching Times

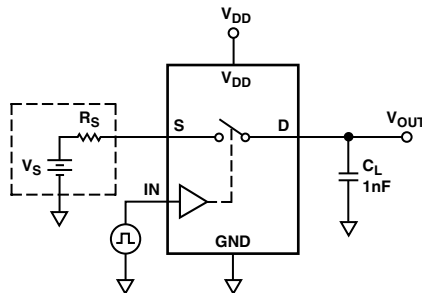
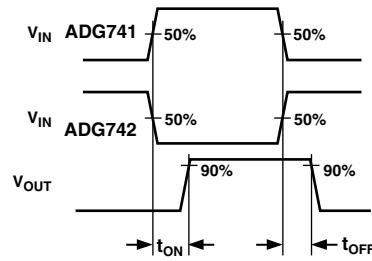

Test Circuit 5. Charge Injection

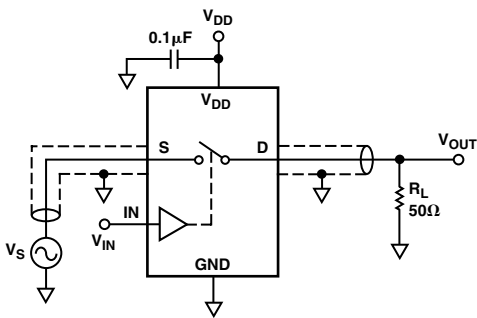
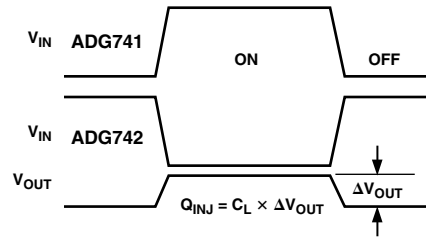

Test Circuit 6. Off Isolation

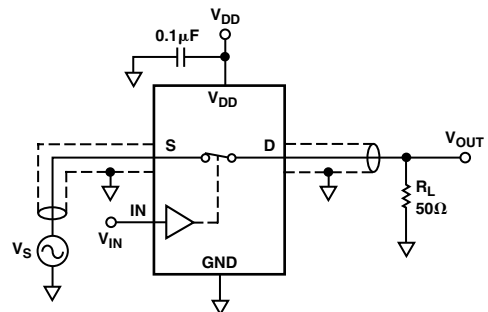

Test Circuit 7. Bandwidth

ADG741/ADG742

APPLICATIONS INFORMATION

The ADG741/ADG742 belongs to Analog Devices' new family of CMOS switches. This series of general-purpose switches have improved switching times, lower on resistance, higher bandwidth, low power consumption and low leakage currents.

ADG741/ADG742 Supply Voltages

Functionality of the ADG741/ADG742 extends from 1.8 V to 5.5 V single supply, which makes it ideal for battery-powered instruments, where important design parameters are power efficiency and performance.

It is important to note that the supply voltage effects the input signal range, the on resistance, and the switching times of the part. By looking at the typical performance characteristics and the specifications, the effects of the power supplies can be clearly seen.

For $V_{DD} = 1.8$ V operation, R_{ON} is typically 40 Ω over the temperature range.

On Response vs. Frequency

Figure 1 illustrates the parasitic components that affect the ac performance of CMOS switches (the switch is shown surrounded by a box). Additional external capacitances will further degrade some performance. These capacitances affect feedthrough, crosstalk and system bandwidth.

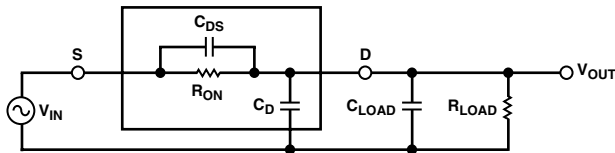

Figure 1. Switch Represented by Equivalent Parasitic Components

The transfer function that describes the equivalent diagram of the switch (Figure 1) is of the form $A(s)$ shown below.

$$A(s) = R_T \left[\frac{s(R_{ON} C_{DS}) + 1}{s(R_{ON} C_T R_T) + 1} \right]$$

where:

$$C_T = C_{LOAD} + C_D + C_{DS}$$

$$R_T = R_{LOAD} / (R_{LOAD} + R_{ON})$$

The signal transfer characteristic is dependent on the switch channel capacitance, C_{DS} . This capacitance creates a frequency zero in the numerator of the transfer function $A(s)$. Because the switch on resistance is small, this zero usually occurs at high frequencies. The bandwidth is a function of the switch output capacitance combined with C_{DS} and the load capacitance. The frequency pole corresponding to these capacitances appears in the denominator of $A(s)$.

The dominant effect of the output capacitance, C_D , causes the pole breakpoint frequency to occur first. Therefore, in order to maximize bandwidth a switch must have a low input and output capacitance and low on resistance. The On Response vs. Frequency plot for the ADG741/ADG742 can be seen in TPC 6.

Off Isolation

Off isolation is a measure of the input signal coupled through an off switch to the switch output. The capacitance, C_{DS} , couples the input signal to the output load, when the switch is off, as shown in Figure 2.

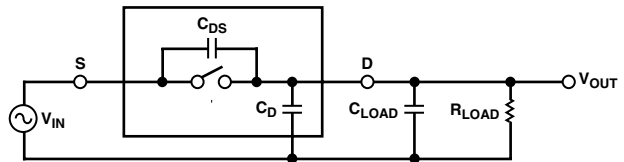

Figure 2. Off Isolation Is Affected by External Load Resistance and Capacitance

The larger the value of C_{DS} , larger values of feedthrough will be produced. The typical performance characteristic graph of TPC 5 illustrates the drop in off-isolation as a function of frequency. From dc to roughly 1 MHz, the switch shows better than -75 dB isolation. Up to frequencies of 10 MHz, the off isolation remains better than -55 dB. As the frequency increases, more and more of the input signal is coupled through to the output. Off-isolation can be maximized by choosing a switch with the smallest C_{DS} as possible. The values of load resistance and capacitance affect off isolation also, as they contribute to the coefficients of the poles and zeros in the transfer function of the switch when open.

$$A(s) = \left[\frac{s(R_{LOAD} C_{DS})}{s(R_{LOAD})(C_T) + 1} \right]$$

OUTLINE DIMENSIONS

Dimensions shown in inches and (mm).

6-Lead Plastic Surface Mount (SC70)

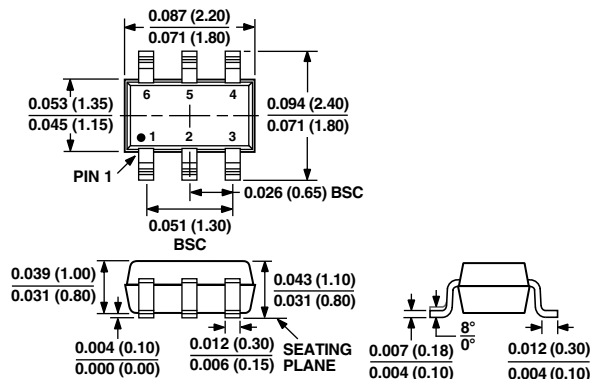

This datasheet has been download from:

www.datasheetcatalog.com

Datasheets for electronics components.