

## N-Channel Enhancement Mode MOSFET

### Features

- 25V/30A,  
 $R_{DS(ON)} = 15m\Omega$  (typ.) @  $V_{GS} = 10V$   
 $R_{DS(ON)} = 22m\Omega$  (typ.) @  $V_{GS} = 4.5V$
- Super High Dense Cell Design
- Avalanche Rated
- Reliable and Rugged
- Lead Free Available (RoHS Compliant)

### Pin Description

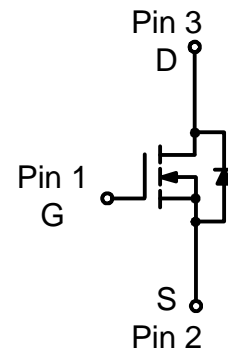
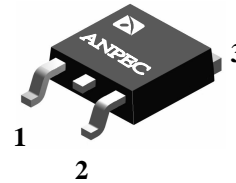

### Applications

- Power Management in Desktop Computer or DC/DC Converters

### Ordering and Marking Information

<p>APM2522N □□-□□□</p> <ul style="list-style-type: none"> <li>□□□ — Lead Free Code</li> <li>□□ — Handling Code</li> <li>□ — Temp. Range</li> <li>□ — Package Code</li> </ul>	<p>Package Code                  U : TO-252                  Operating Junction Temp. Range                  C : -55 to 150 °C                  Handling Code                  TU : Tube    TR : Tape &amp; Reel                  Lead Free Code                  L : Lead Free Device    Blank : Original Device</p>
<p>APM2522N U : </p>	<p>XXXXX - Date Code</p>

Note: ANPEC lead-free products contain molding compounds and 100% matte tin plate termination finish; which are fully compliant with RoHS and compatible with both SnPb and lead-free soldering operations. ANPEC lead-free products meet or exceed the lead-free requirements of IPC/JEDEC J STD-020C for MSL classification at lead-free peak reflow temperature.

ANPEC reserves the right to make changes to improve reliability or manufacturability without notice, and advise customers to obtain the latest version of relevant information to verify before placing orders.

## Absolute Maximum Ratings

Symbol	Parameter	Rating	Unit	
<b>Common Ratings</b> ( $T_A = 25^\circ\text{C}$ Unless Otherwise Noted)				
$V_{DSS}$	Drain-Source Voltage	25	V	
$V_{GSS}$	Gate-Source Voltage	$\pm 20$		
$T_J$	Maximum Junction Temperature	150	$^\circ\text{C}$	
$T_{STG}$	Storage Temperature Range	-55 to 150	$^\circ\text{C}$	
$I_S$	Diode Continuous Forward Current	$T_C=25^\circ\text{C}$	20	A
$I_{DP}$	300 $\mu\text{s}$ Pulse Drain Current Tested	$T_C=25^\circ\text{C}$	100	A
		$T_C=100^\circ\text{C}$	70	
<b>Mounted on Large Heat Sink</b>				
$I_D$	Continuous Drain Current	$T_C=25^\circ\text{C}$	30*	A
		$T_C=100^\circ\text{C}$	20	
$P_D$	Maximum Power Dissipation	$T_C=25^\circ\text{C}$	50	W
		$T_C=100^\circ\text{C}$	20	
$R_{\theta JC}$	Thermal Resistance-Junction to Case	2.5	$^\circ\text{C/W}$	
<b>Mounted on PCB of 1in<sup>2</sup> Pad Area</b>				
$I_D$	Continuous Drain Current	$T_A=25^\circ\text{C}$	9	A
		$T_A=100^\circ\text{C}$	6	
$P_D$	Maximum Power Dissipation	$T_A=25^\circ\text{C}$	2.5	W
		$T_A=100^\circ\text{C}$	1	
$R_{\theta JA}$	Thermal Resistance-Junction to Ambient	50	$^\circ\text{C/W}$	
<b>Mounted on PCB of Minimum Footprint</b>				
$I_D$	Continuous Drain Current	$T_A=25^\circ\text{C}$	7	A
		$T_A=100^\circ\text{C}$	4	
$P_D$	Maximum Power Dissipation	$T_A=25^\circ\text{C}$	1.5	$^\circ\text{C/W}$
		$T_A=100^\circ\text{C}$	0.5	
$R_{\theta JA}$	Thermal Resistance-Junction to Ambient	75	$^\circ\text{C/W}$	

Notes :

\* Current limited by bond wire.

## Electrical Characteristics $(T_A = 25^\circ\text{C})$

Symbol	Parameter	Test Condition	Min.	Typ.	Max.	Unit
<b>Static Characteristics</b>						
$BV_{DSS}$	Drain-Source Breakdown Voltage	$V_{GS}=0V, I_{DS}=250\mu A$	25			V
$I_{DSS}$	Zero Gate Voltage Drain Current	$V_{DS}=20V, V_{GS}=0V$ $T_J=85^\circ\text{C}$			1	$\mu A$
					30	
$V_{GS(th)}$	Gate Threshold Voltage	$V_{DS}=V_{GS}, I_{DS}=250\mu A$	1	1.5	2.5	V
$I_{GSS}$	Gate Leakage Current	$V_{GS}=\pm 20V, V_{DS}=0V$			$\pm 100$	nA
$R_{DS(ON)}^a$	Drain-Source On-state Resistance	$V_{GS}=10V, I_{DS}=20A$		15	20	m $\Omega$
		$V_{GS}=4.5V, I_{DS}=10A$		22	28	
<b>Diode Characteristics</b>						
$V_{SD}^a$	Diode Forward Voltage	$I_{SD}=10A, V_{GS}=0V$		0.7	1.1	V
$t_{rr}$	Reverse Recovery Time	$I_{SD}=10A, di_{SD}/dt = 100A/\mu s$		50		ns
$Q_{rr}$	Reverse Recovery Charge			3		nC
<b>Dynamic Characteristics<sup>b</sup></b>						
$R_G$	Gate Resistance	$V_{GS}=0V, V_{DS}=0V, F=1\text{MHz}$		2		$\Omega$
$C_{iss}$	Input Capacitance	$V_{GS}=0V,$ $V_{DS}=15V,$ Frequency=1.0MHz		825		pF
$C_{oss}$	Output Capacitance			125		
$C_{rss}$	Reverse Transfer Capacitance			85		
$t_{d(ON)}$	Turn-on Delay Time	$V_{DD}=15V, R_L=15\Omega,$ $I_{DS}=1A, V_{GEN}=10V,$ $R_G=6\Omega$		13	24	ns
$t_r$	Turn-on Rise Time			19	35	
$t_{d(OFF)}$	Turn-off Delay Time			31	57	
$t_f$	Turn-off Fall Time			5	10	
<b>Gate Charge Characteristics<sup>b</sup></b>						
$Q_g$	Total Gate Charge	$V_{DS}=15V, V_{GS}=10V,$ $I_{DS}=20A$		17	24	nC
$Q_{gs}$	Gate-Source Charge			2		
$Q_{gd}$	Gate-Drain Charge			5		

Notes:

a : Pulse test ; pulse width  $\leq 300\mu s$ , duty cycle  $\leq 2\%$ .

b : Guaranteed by design, not subject to production testing.

## Typical Characteristics

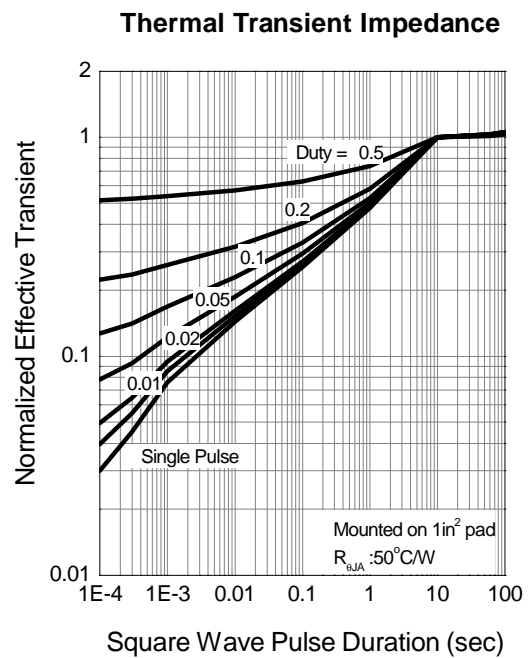
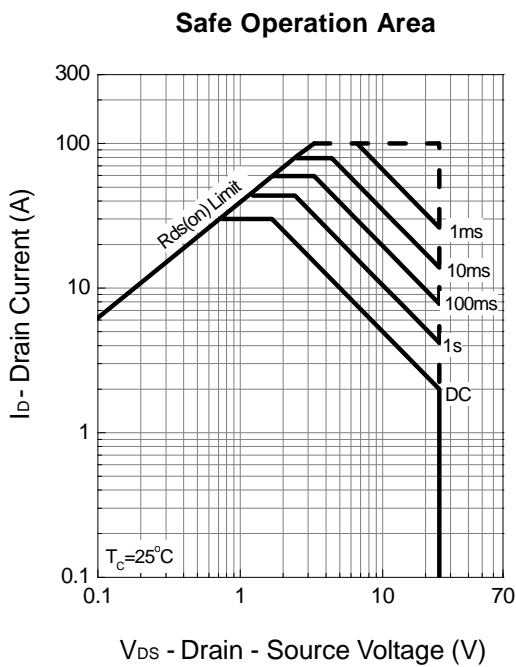
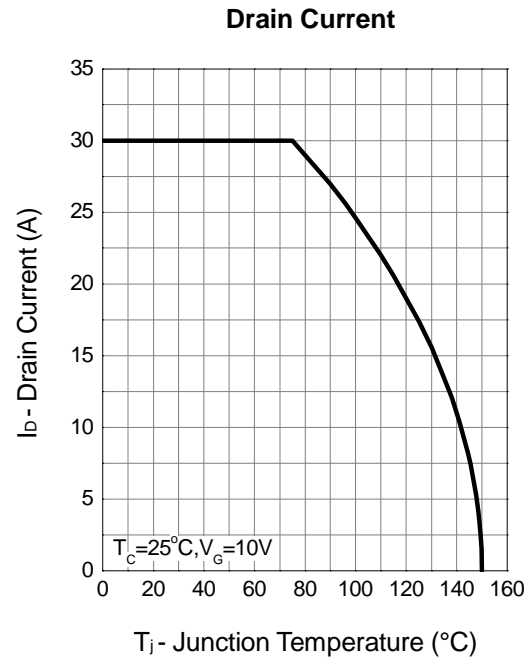
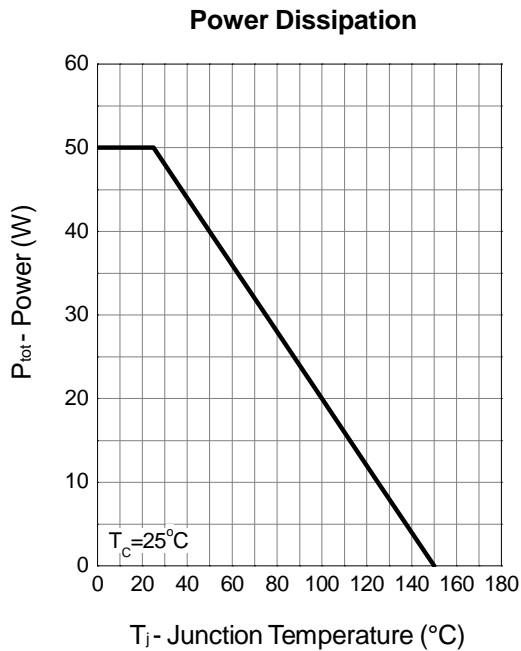

Typical Characteristics (Cont.)

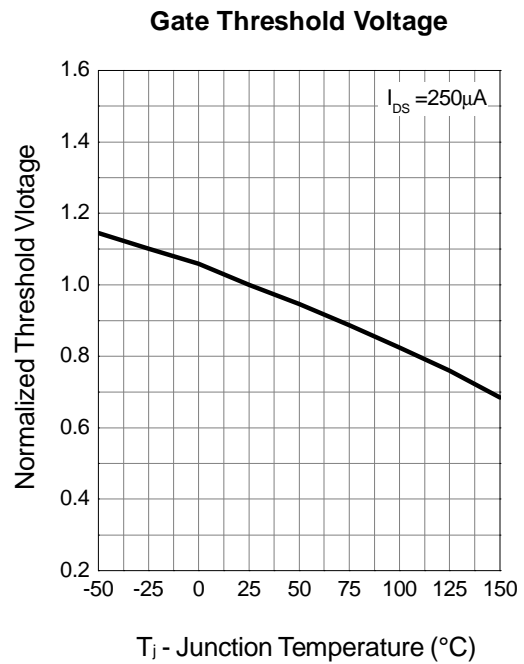
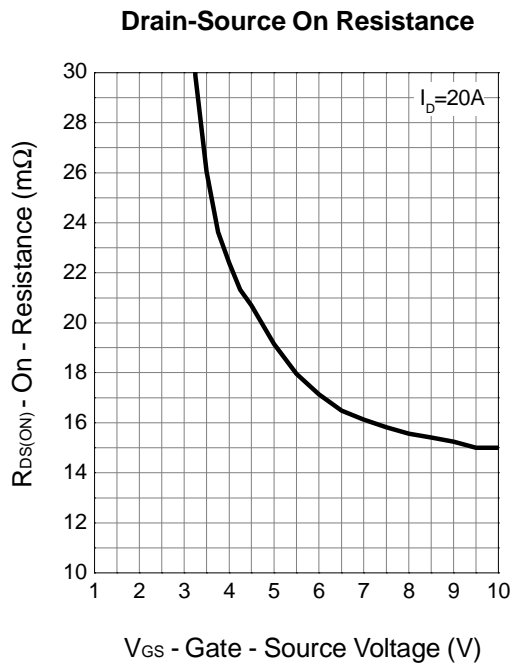
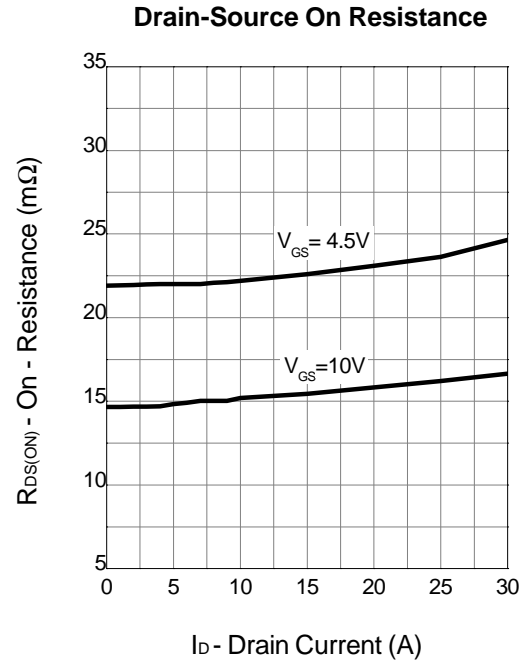
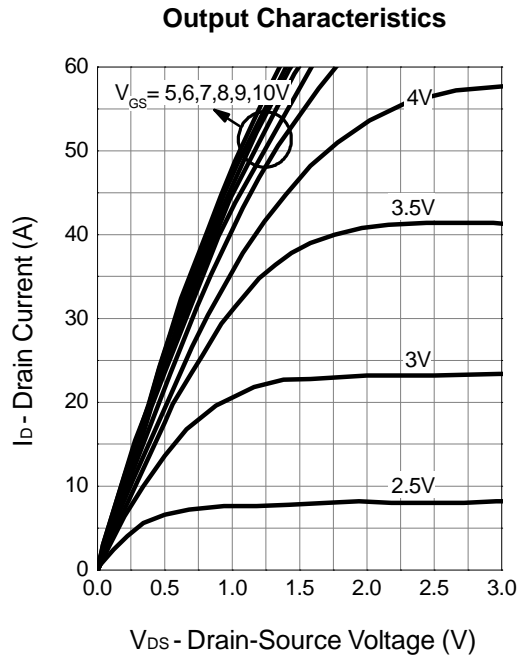

Typical Characteristics (Cont.)

Drain-Source On Resistance

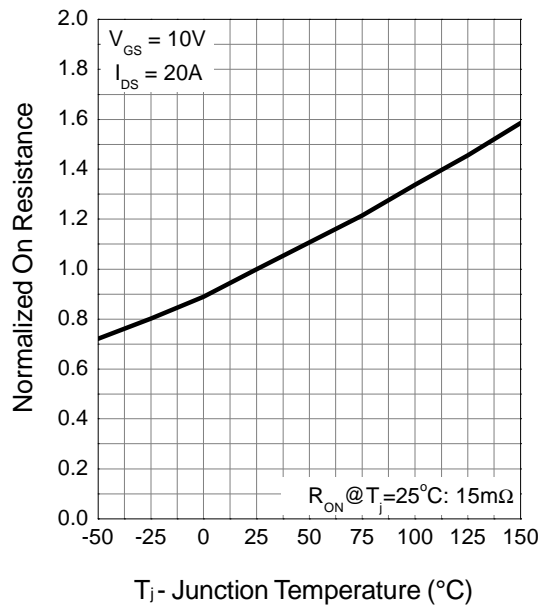

Source-Drain Diode Forward

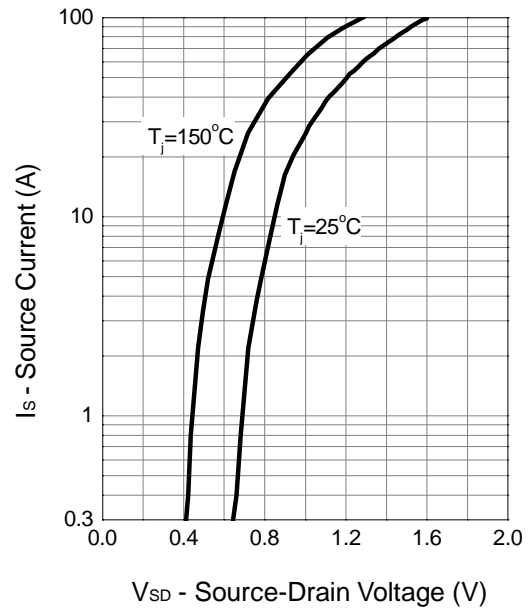

Capacitance

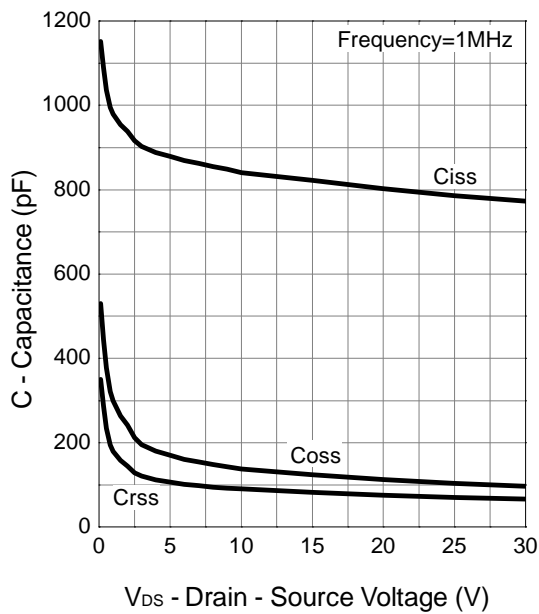

Gate Charge

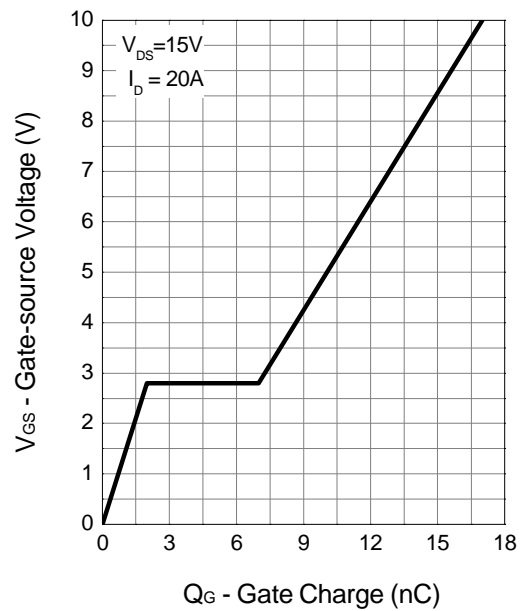

## Avalanche Test Circuit and Waveforms

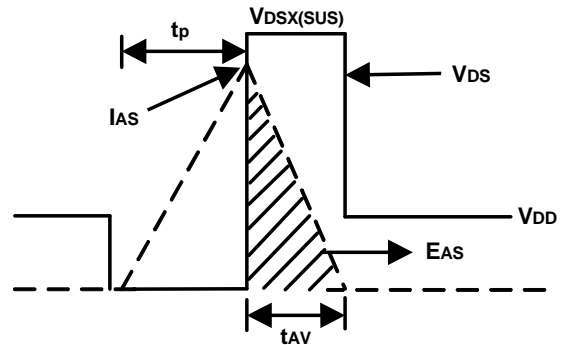
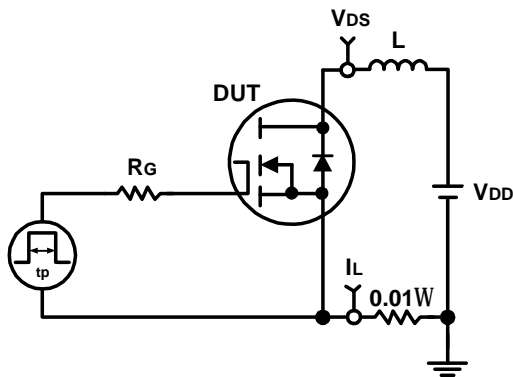

## Avalanche Test Circuit and Waveforms

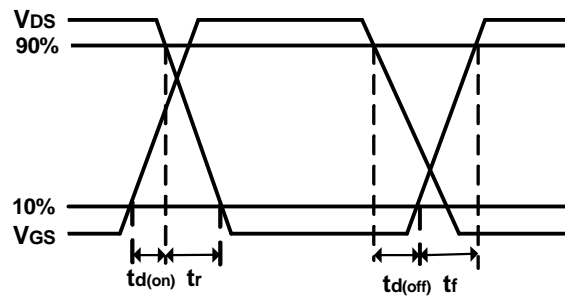
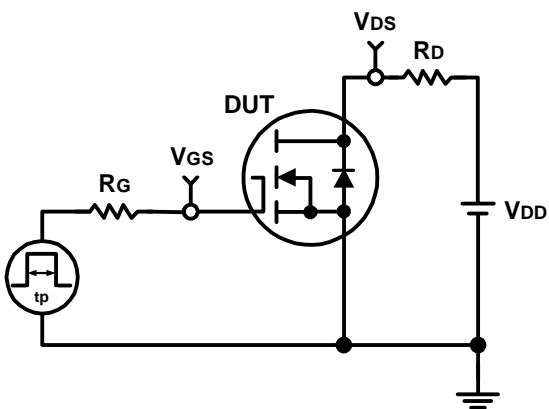

## Packaging Information

TO-252 (Reference JEDEC Registration TO-252)

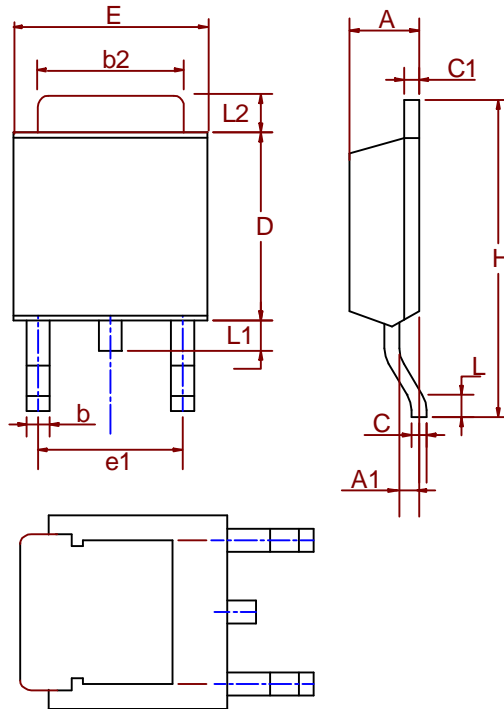

Dim	Millimeters		Inches	
	Min.	Max.	Min.	Max.
A	2.18	2.39	0.086	0.094
A1	0.89	1.27	0.035	0.050
b	0.508	0.89	0.020	0.035
b2	5.207	5.461	0.205	0.215
C	0.46	0.58	0.018	0.023
C1	0.46	0.58	0.018	0.023
D	5.334	6.22	0.210	0.245
E	6.35	6.73	0.250	0.265
e1	3.96	5.18	0.156	0.204
H	9.398	10.41	0.370	0.410
L	0.51		0.020	
L1	0.64	1.02	0.025	0.040
L2	0.89	2.032	0.035	0.080



## Physical Specifications

Terminal Material	Solder-Plated Copper (Solder Material : 90/10 or 63/37 SnPb)
Lead Solderability	Meets EIA Specification RS186-91, ANSI/J-STD-002 Category 3.

## Reflow Condition (IR/Convection or VPR Reflow)

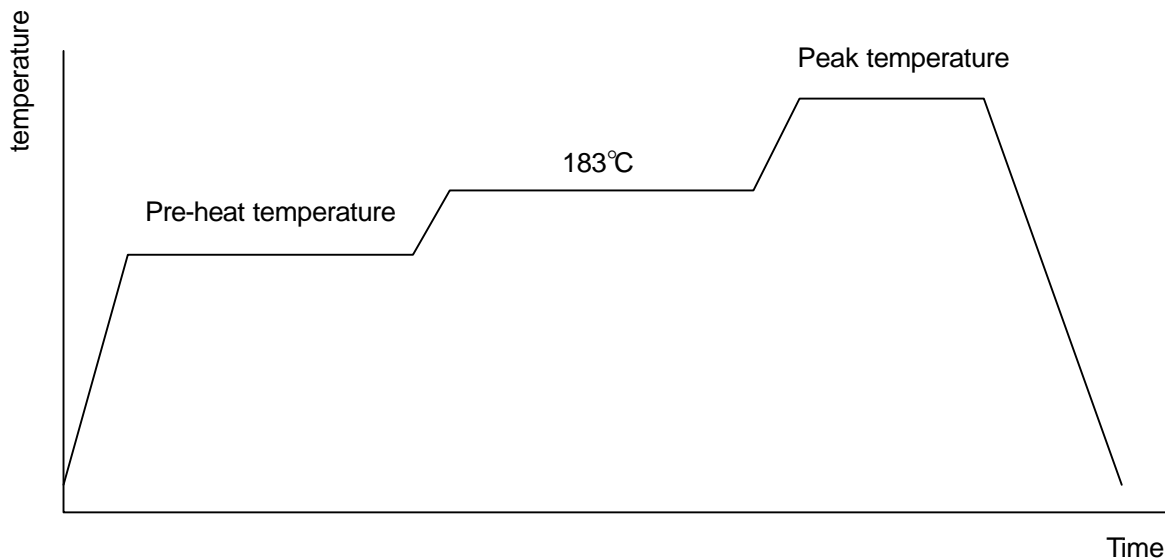

## Classification Reflow Profiles

	Convection or IR/ Convection	VPR
Average ramp-up rate (183°C to Peak)	3°C/ second max.	10°C /second max.
Preheat temperature (125 ±25°C)	120 seconds max.	
Temperature maintained above 183°C	60~150 seconds	
Time within 5°C of actual peak temperature	10~20 seconds	60 seconds
Peak temperature range	220 + 5/-0°C or 235 +5°C/-0°C	215~ 219 °C or 235 +5°C/-0°C
Ramp-down rate	6°C /second max.	10°C /second max.
Time 25°C to peak temperature	6 minutes max.	

## Classification Reflow Profiles

pkg. thickness ≥ 2.5mm and all bags	pkg. thickness < 2.5mm and pkg. volume ≥ 350mm <sup>3</sup>	pkg. thickness < 2.5mm and pkg. volume < 350mm <sup>3</sup>
Convection 220 +5/-0 °C		Convection 235 +5/-0 °C
VPR 215-219 °C		VPR 235 +5/-0 °C
IR/Convection 220 +5/-0 °C		IR/Convection 220 +5/-0 °C

### Reliability test program

Test item	Method	Description
SOLDERABILITY	MIL-STD-883D-2003	245°C, 5 SEC
HOLT	MIL-STD 883D-1005.7	1000 Hrs Bias @ 125°C
PCT	JESD-22-B, A102	168 Hrs, 100% RH, 121°C
TST	MIL-STD 883D-1011.9	-65°C ~ 150°C, 200 Cycles

### Carrier Tape & Reel Dimensions

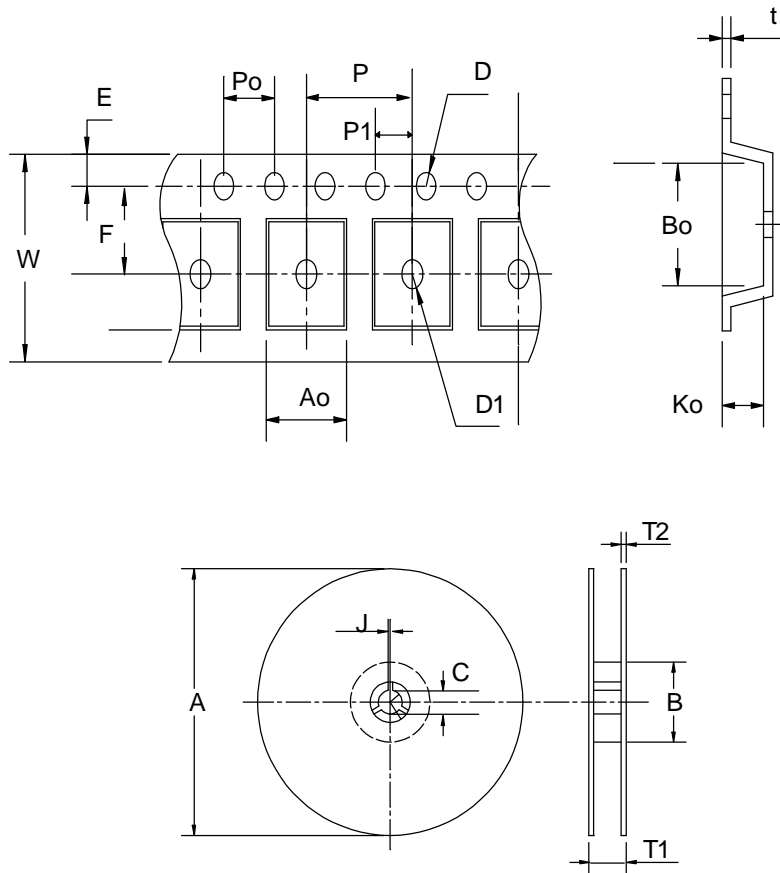

Application	A	B	C	J	T1	T2	W	P	E
TO-252	330±3	100±2	13±0.5	2±0.5	16.4+0.3 -0.2	2.5±0.5	16+0.3 16-0.1	8±0.1	1.75±0.1
	F	D	D1	Po	P1	Ao	Bo	Ko	t
	7.5±0.1	1.5±0.1	1.5±0.25	4.0±0.1	2.0±0.1	6.8±0.1	10.4±0.1	2.5±0.1	0.3±0.05

(mm)

## Customer Service

### **Anpec Electronics Corp.**

Head Office :

No.6, Dusing 1st Road, SBIP,

Hsin-Chu, Taiwan, R.O.C.

Tel : 886-3-5642000

Fax : 886-3-5642050

Taipei Branch :

7F, No. 137, Lane 235, Pac Chiao Rd.,

Hsin Tien City, Taipei Hsien, Taiwan, R. O. C.

Tel : 886-2-89191368

Fax : 886-2-89191369