

## P-Channel Enhancement Mode MOSFET

### Features

- -30V/-11A,  $R_{DS(ON)} = 17m\Omega(\text{typ.}) @ V_{GS} = -10V$   
 $R_{DS(ON)} = 24m\Omega(\text{typ.}) @ V_{GS} = -5V$
- Super High Density Cell Design
- Reliable and Rugged
- TO-252 Package

### Pin Description

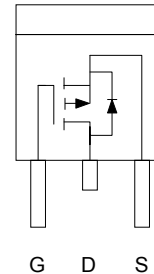



Top View of TO-252

### Applications

- Power Management in Notebook Computer, Portable Equipment and Battery Powered Systems

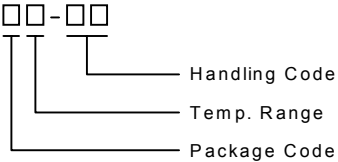
### Ordering and Marking Information

<p>APM3020P □□-□□</p>  <p>Handling Code Temp. Range Package Code</p>	<p>Package Code U : TO-252 Operating Junction Temp. Range C : -55 to 125°C Handling Code TU : Tube TR : Tape &amp; Reel</p>
<p>APM3020P U : </p>	<p>XXXXX - Date Code</p>

### Absolute Maximum Ratings ( $T_A = 25^\circ\text{C}$ unless otherwise noted)

Symbol	Parameter	Rating	Unit	
$V_{DSS}$	Drain-Source Voltage	-30	V	
$V_{GSS}$	Gate-Source Voltage	$\pm 20$		
$I_D^*$	Maximum Drain Current – Continuous	-40	A	
$I_{DM}$	Maximum Drain Current – Pulsed	-70		
$P_D$	Maximum Power Dissipation	$T_A = 25^\circ\text{C}$	50	W
		$T_A = 100^\circ\text{C}$	20	

ANPEC reserves the right to make changes to improve reliability or manufacturability without notice, and advise customers to obtain the latest version of relevant information to verify before placing orders.

## Absolute Maximum Ratings ( $T_A = 25^\circ\text{C}$ unless otherwise noted)

Symbol	Parameter	Rating	Unit
$T_J$	Maximum Junction Temperature	150	$^\circ\text{C}$
$T_{STG}$	Storage Temperature Range	-55 to 150	$^\circ\text{C}$
$R_{\theta JC}$	Thermal Resistance – Junction to Case	2.5	$^\circ\text{C/W}$

## Electrical Characteristics ( $T_A = 25^\circ\text{C}$ unless otherwise noted)

Symbol	Parameter	Test Condition	APM3020P			Unit
			Min.	Typ.	Max.	
<b>Static</b>						
$BV_{DSS}$	Drain-Source Breakdown Voltage	$V_{GS}=0V, I_{DS}=-250A$	-30			V
$I_{DSS}$	Zero Gate Voltage Drain Current	$V_{DS}=-24V, V_{GS}=0V$			-1	$\mu\text{A}$
$V_{GS(th)}$	Gate Threshold Voltage	$V_{DS}=V_{GS}, I_{DS}=-250\mu\text{A}$	-1		-3	V
$I_{GSS}$	Gate Leakage Current	$V_{GS}=\pm 20V, V_{DS}=0V$			$\pm 100$	nA
$R_{DS(ON)}^a$	Drain-Source On-state Resistance	$V_{GS}=-10V, I_{DS}=-11A$		17	20	$\text{m}\Omega$
		$V_{GS}=-5V, I_{DS}=-7A$		24	30	
$V_{SD}^a$	Diode Forward Voltage	$I_{SD}=-11A, V_{GS}=0V$	-1.3		-1.3	V
<b>Dynamic<sup>b</sup></b>						
$Q_g$	Total Gate Charge	$V_{DS}=-15V, V_{GS}=-4.5V,$ $I_{DS}=-4.6A$		23	30	nC
$Q_{gs}$	Gate-Source Charge			10		
$Q_{gd}$	Gate-Drain Charge			9		
$t_{d(ON)}$	Turn-on Delay Time	$V_{DD}=-15V, I_{DS}=-6A,$ $V_{GEN}=-10V, R_G=1\Omega$ $R_L=2.5\Omega$		16	30	ns
$T_r$	Turn-on Rise Time			22	30	
$t_{d(OFF)}$	Turn-off Delay Time			75	120	
$T_f$	Turn-off Fall Time			31	80	
$C_{iss}$	Input Capacitance	$V_{GS}=0V$		3720		pF
$C_{oss}$	Output Capacitance	$V_{DS}=-25V$		580		
$C_{rss}$	Reverse Transfer Capacitance	Frequency=1.0MHz		245		

### Notes

<sup>a</sup> : Guaranteed by design, not subject to production testing

<sup>b</sup> : Pulse test ; pulse width  $\leq 500\mu\text{s}$ , duty cycle  $\leq 2\%$

## Typical Characteristics

Output Characteristics

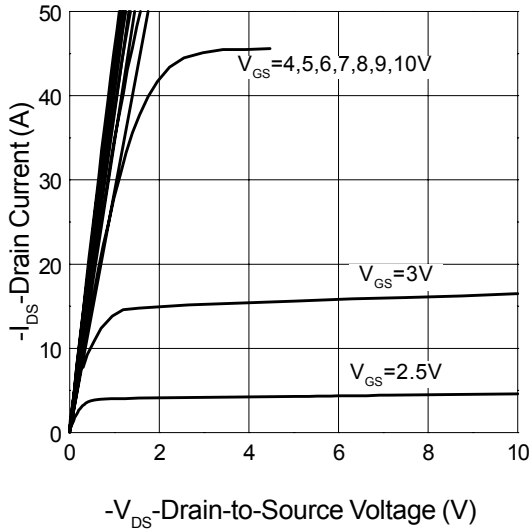

Transfer Characteristics

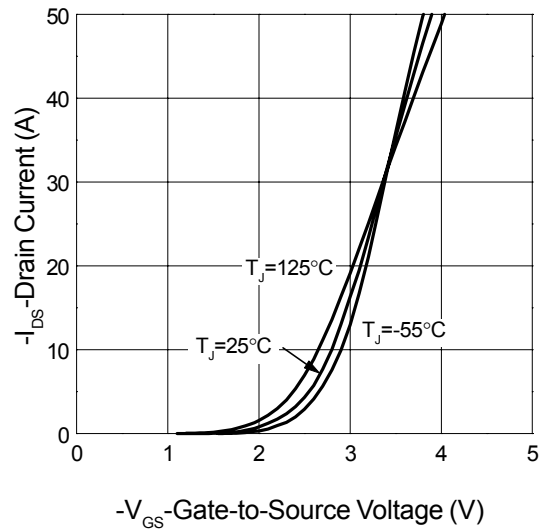

Threshold Voltage vs. Junction Temperature

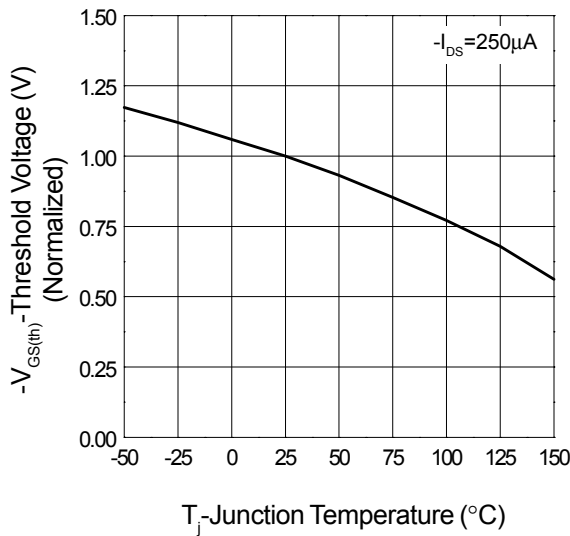

On-Resistance vs. Drain Current

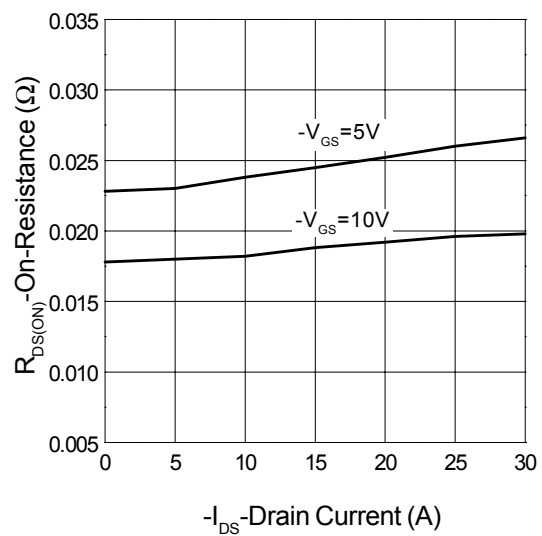

Typical Characteristics Cont.

On-Resistance vs. Gate-to-Source Voltage

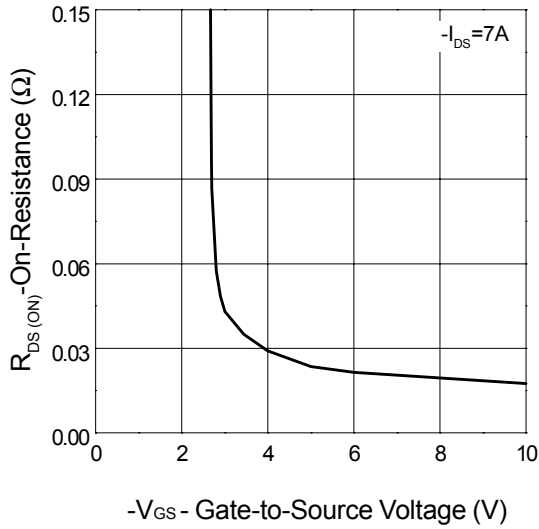

On-Resistance vs. Junction Temperature

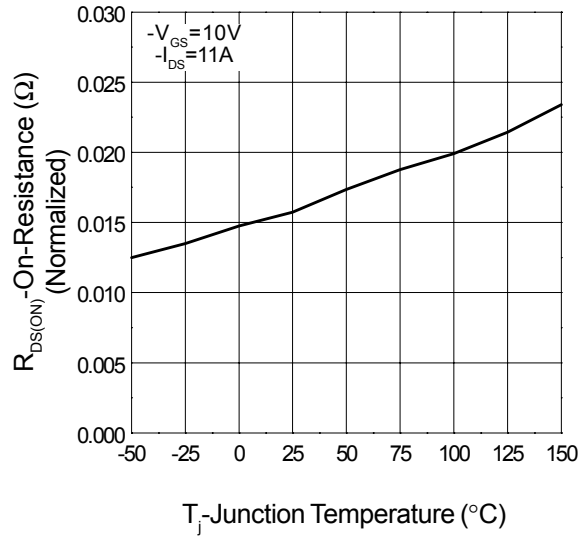

Gate Charge

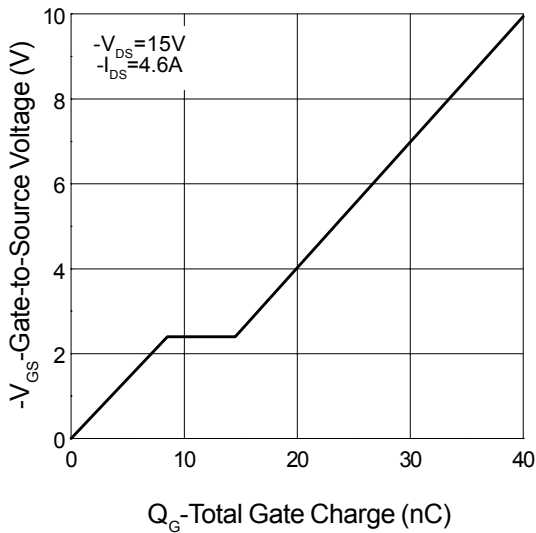

Capacitance Characteristics

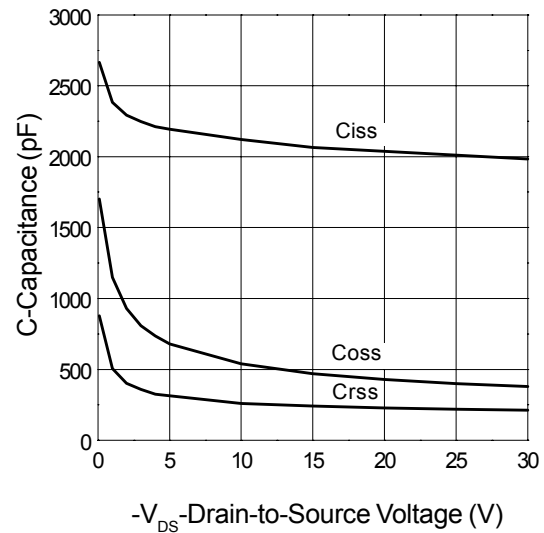

Typical Characteristics Cont.

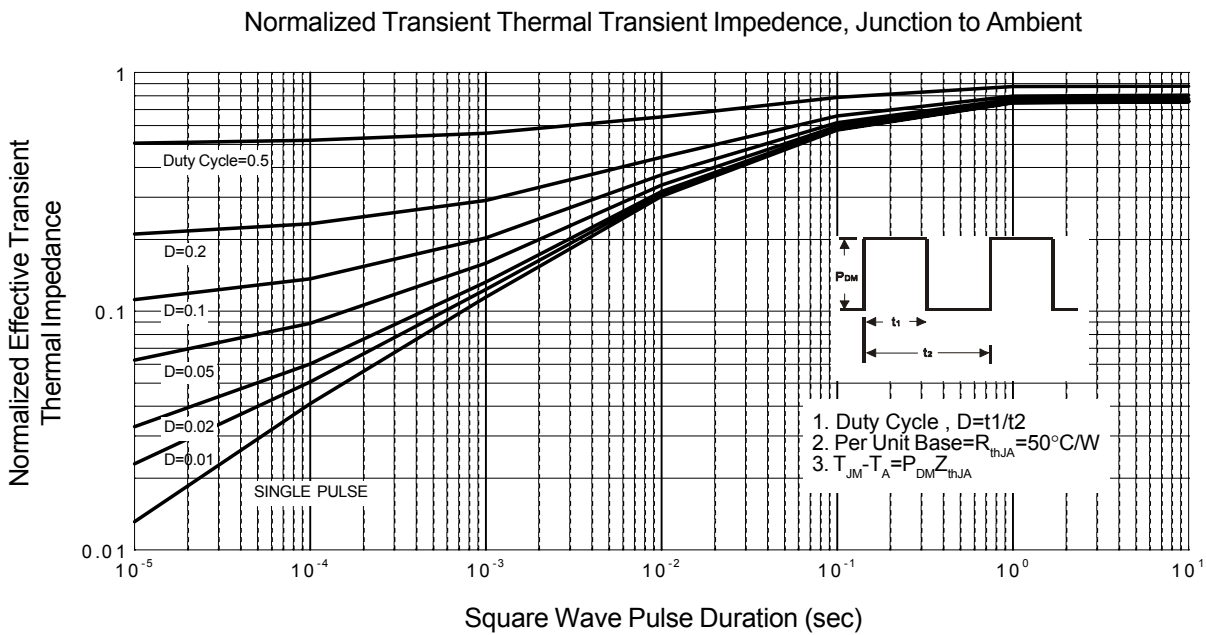
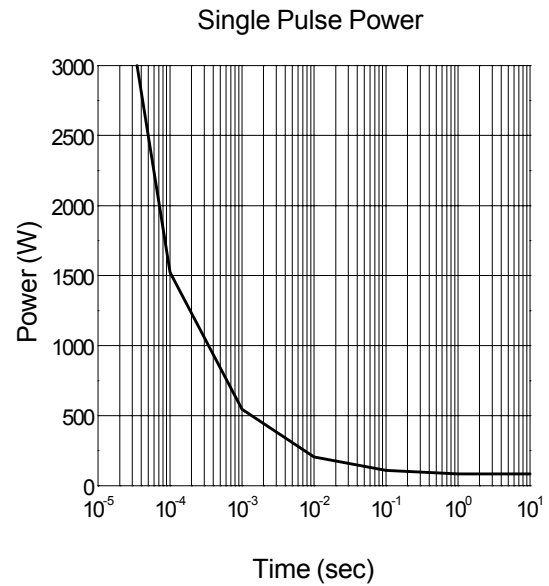
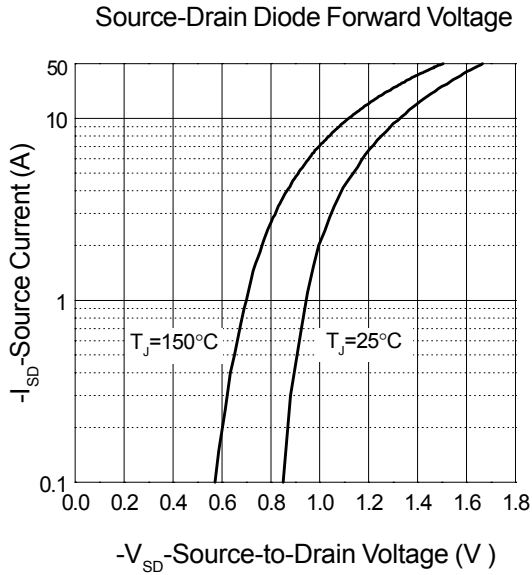

## Packaging Information

TO-252( Reference JEDEC Registration TO-252)

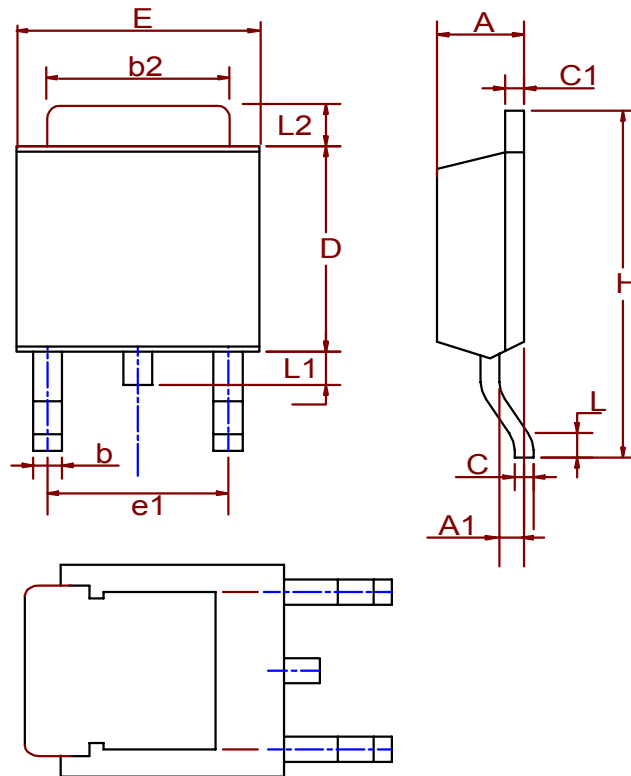

Dim	Millimeters		Inches	
	Min.	Max.	Min.	Max.
A	2.18	2.39	0.086	0.094
A1	0.89	1.27	0.035	0.050
b	0.508	0.89	0.020	0.035
b2	5.207	5.461	0.205	0.215
C	0.46	0.58	0.018	0.023
C1	0.46	0.58	0.018	0.023
D	5.334	6.22	0.210	0.245
E	6.35	6.73	0.250	0.265
e1	3.96	5.18	0.156	0.204
H	9.398	10.41	0.370	0.410
L	0.51		0.020	
L1	0.64	1.02	0.025	0.040
L2	0.89	2.032	0.035	0.080

## Physical Specifications

Terminal Material	Solder-Plated Copper (Solder Material : 90/10 or 63/37 SnPb)
Lead Solderability	Meets EIA Specification RSI86-91, ANSI/J-STD-002 Category 3.

## Reflow Condition (IR/Convection or VPR Reflow)

Reference JEDEC Standard J-STD-020A APRIL 1999

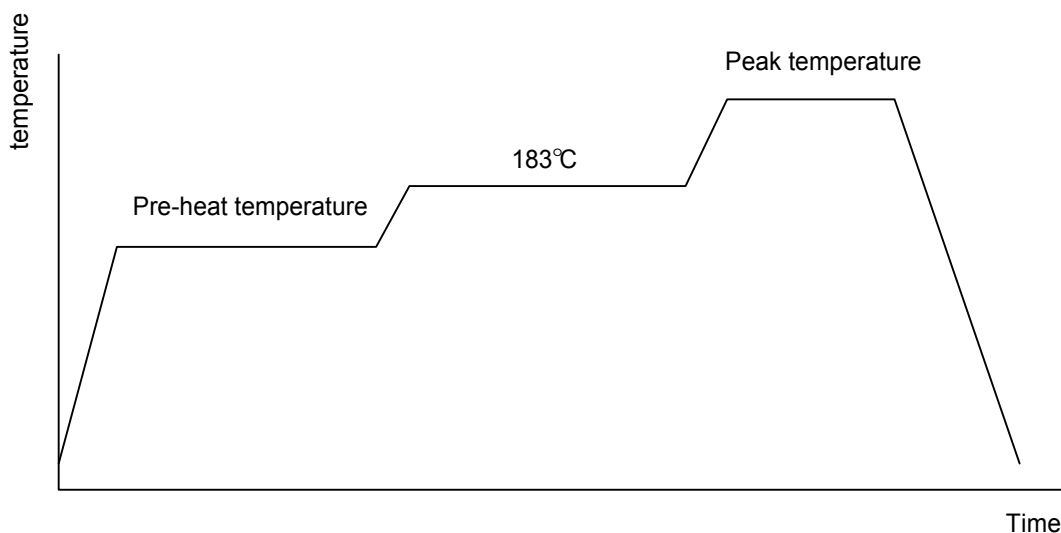

## Classification Reflow Profiles

	Convection or IR/ Convection	VPR
Average ramp-up rate(183°C to Peak)	3°C/second max.	10 °C /second max.
Preheat temperature 125 ± 25°C)	120 seconds max	
Temperature maintained above 183°C	60 – 150 seconds	
Time within 5°C of actual peak temperature	10 –20 seconds	60 seconds
Peak temperature range	220 +5/-0°C or 235 +5/-0°C	215-219°C or 235 +5/-0°C
Ramp-down rate	6 °C /second max.	10 °C /second max.
Time 25°C to peak temperature	6 minutes max.	

## Package Reflow Conditions

pkg. thickness ≥ 2.5mm and all bgas	pkg. thickness < 2.5mm and pkg. volume ≥ 350 mm <sup>3</sup>	pkg. thickness < 2.5mm and pkg. volume < 350mm <sup>3</sup>
Convection 220 +5/-0 °C		Convection 235 +5/-0 °C
VPR 215-219 °C		VPR 235 +5/-0 °C
IR/Convection 220 +5/-0 °C		IR/Convection 235 +5/-0 °C

## Reliability test program

Test item	Method	Description
SOLDERABILITY	MIL-STD-883D-2003	245°C, 5 SEC
HOLT	MIL-STD 883D-1005.7	1000 Hrs Bias @ 125°C
PCT	JESD-22-B, A102	168 Hrs, 100% RH, 121°C
TST	MIL-STD 883D-1011.9	-65°C ~ 150°C, 200 Cycles

## Carrier Tape

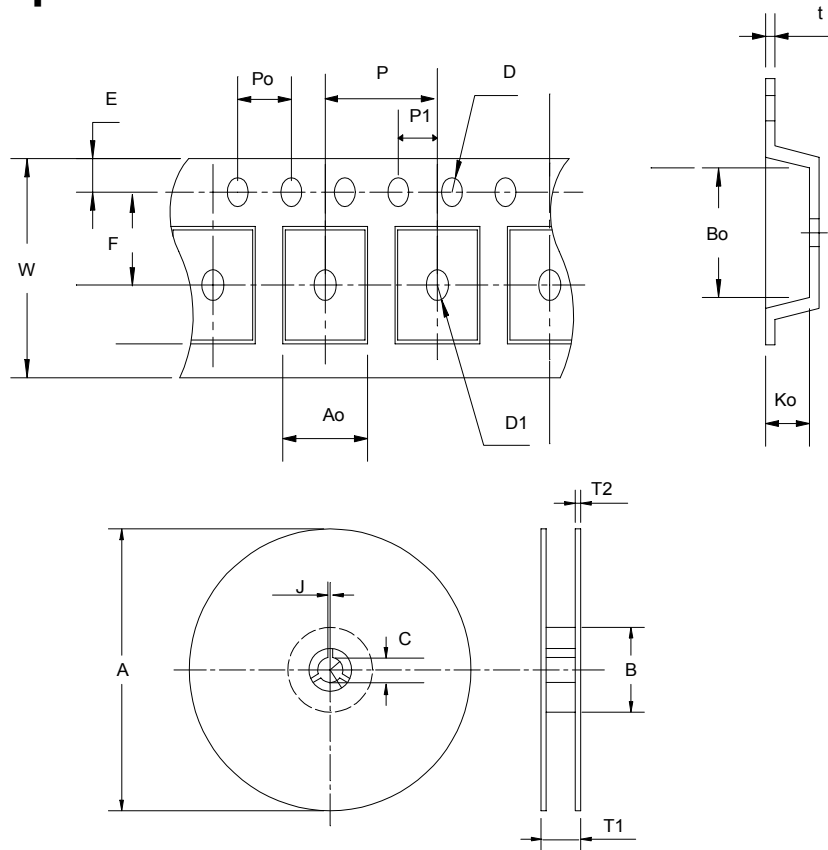

Application	A	B	C	J	T1	T2	W	P	E
TO-252	330 ± 3	100 ± 2	13 ± 0.5	2 ± 0.5	16.4 + 0.3 - 0.2	2.5 ± 0.5	16 + 0.3 - 0.1	8 ± 0.1	1.75 ± 0.1
	F	D	D1	Po	P1	Ao	Bo	Ko	t
	7.5 ± 0.1	1.5 ± 0.1	1.5 ± 0.25	4.0 ± 0.1	2.0 ± 0.1	6.8 ± 0.1	10.4 ± 0.1	2.5 ± 0.1	0.3 ± 0.05



## Cover Tape Dimensions

Application	Carrier Width	Cover Tape Width	Devices Per Reel
TO- 252	16	13.3	2500

## Customer Service

### Anpec Electronics Corp.

Head Office :

5F, No. 2 Li-Hsin Road, SBIP,  
Hsin-Chu, Taiwan, R.O.C.  
Tel : 886-3-5642000  
Fax : 886-3-5642050

Taipei Branch :

7F, No. 137, Lane 235, Pac Chiao Rd.,  
Hsin Tien City, Taipei Hsien, Taiwan, R. O. C.  
Tel : 886-2-89191368  
Fax : 886-2-89191369