

High IIP3 PIN Diode Variable Attenuator
0.80-1.0 GHz

MA4VAT904-1061T
V2

Features

- 1.0 dB Insertion Loss, Typical
- 12 dB Return Loss, Typical
- 25 dB Attenuation, Typical
- 45 dBm IIP3, Typical (1MHz Offset, @ +0dBm Pinc)
- SOIC-8 Surface Mount Package
- RoHs Compliant

Extra Features

- Covers the following Bands:
 - GSM
 - AMPS
- Usable Bandwidth: 0.60 GHz to 1.20 GHz
- 1.5 dB Insertion Loss, Typical
- 1.8:1 VSWR, Typical
- 18.5 dB Attenuation, Typical

Description and Applications

M/A-COM's MA4VAT904-1061T is a HMIC PIN Diode Variable Attenuator which utilizes an integrated 90 degree 3dB hybrid with a pair of Silicon PIN Diodes to perform the required attenuation function as D.C. Voltage (Current) is applied.

This device operates from 0 to 1.9 Volts at 1.89 mA typical control current for maximum attenuation. The user can add external biasing resistors to the bias ports for higher voltage requirements as required.

M/A-COM's MA4VAT904-1061T PIN Diode Variable Attenuator is designed for AGC Circuit Applications requiring:

- Lower Insertion Loss
- Lower distortion through attenuation
- Larger dynamic range for wide spread spectrum applications

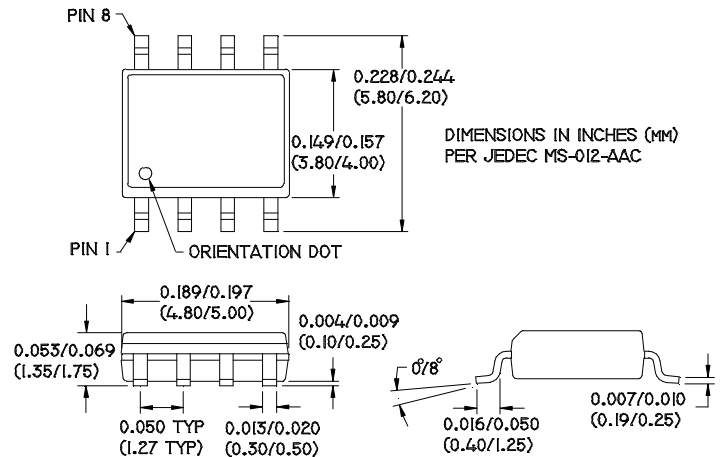

SOIC-8 PIN Configuration (Topview)

PIN	Function	Comments
1	DC1	
2	GND	
3	GND	
4	RFin/out	Symetrical as RF Input/Ouput
5	RFout/in	Symetrical as RF Input/Ouput
6	GND	
7	GND	
8	DC2	

Absolute Maximum Ratings
@ +25 °C

Parameter	Maximum Ratings
Operating Temperature	-40 °C to +85 °C
Storage Temperature	-65 °C to +150 °C
Junction Temperature	+175 °C
RF C.W. Incident Power	+33 dBm C.W.
Reversed Current @ -30 V	50nA
Control Current	50 mA per Diode

Notes:

1. All the above values are at +25 °C, unless otherwise noted.
2. Exceeding these limits may cause permanent damage.

**High IIP3 PIN Diode Variable Attenuator
0.80-1.0 GHz**

**MA4VAT904-1061T
V2**

Electrical Specifications @ +25 °C

Parameter	Frequency Band	Unit	Min	Typ	Max
No DC Bias RF Parameter					
Insertion Loss	0.80 GHz—1.00 GHz	dB	-	1.0	1.2
Input Return Loss		dB	11	12	-
Output Return Loss		dB	11	12	-
P1dB		dBm	30	-	-
Input IP3		dBm	45	49	-
Control Voltage		V	-	0 V @ OuA	-
DC Bias RF Parameter					
Maximum Attenuation	0.80 GHz—1.00 GHz	dB	18.5	24	-
Input Return Loss @ Max Attenuation		dB	15	21	-
Output Return Loss @ Max Attenuation		dB	15	21	-
Input IP3		dBm	36	39	-
Control Voltage @ Max Attenuation		V	-	1.9 V @ 1.89 mA	-

Typical RF Performance Over Industry Designated RF Frequency Bands

Band		Freq	I. Loss	Att.	R. Loss	IIP3	Phase -Relative-
		(MHz)	(dB)	(dB)	(dB)	(dBm)	(Degree)
AMPS	RX	824-849	0.9	22	12	45	-15°
	TX	869-894	0.9	22	12	45	
GSM	RX	880-915	1.2	20	11	45	-20°
	TX	925-960	1.2	20	11	45	

Notes:

1. All are typical values only.
2. Relative phase is the measured Insertion Phase difference between Insertion Loss and 15 dB Attenuation. (Please refer to the plots below)

**High IIP3 PIN Diode Variable Attenuator
0.80-1.0 GHz**

**MA4VAT904-1061T
V2**

Plots of Typical RF Characteristics @ +25 °C

Typical Insertion Loss & Attenuation Plot

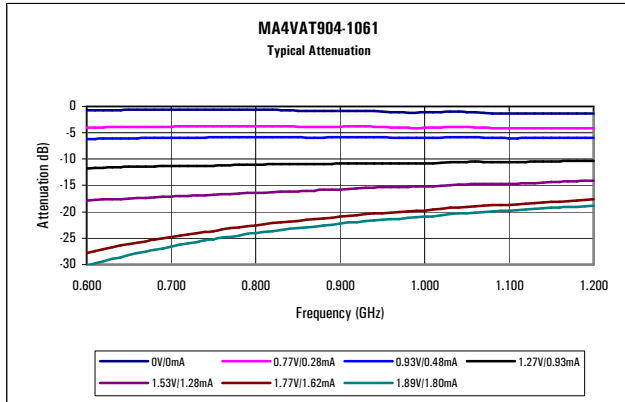

Typical Attenuation vs Voltage Plot

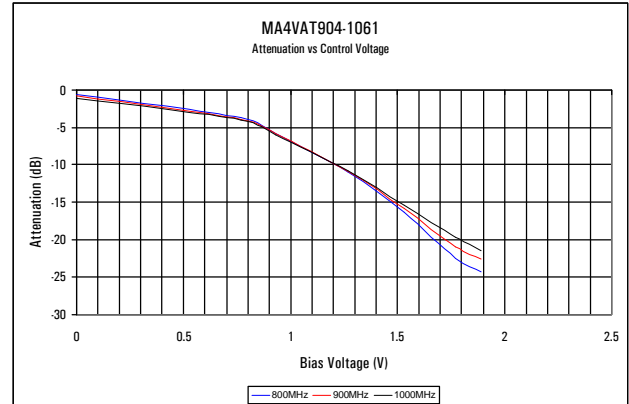

Typical Return Loss @ All Attenuation Levels Plot

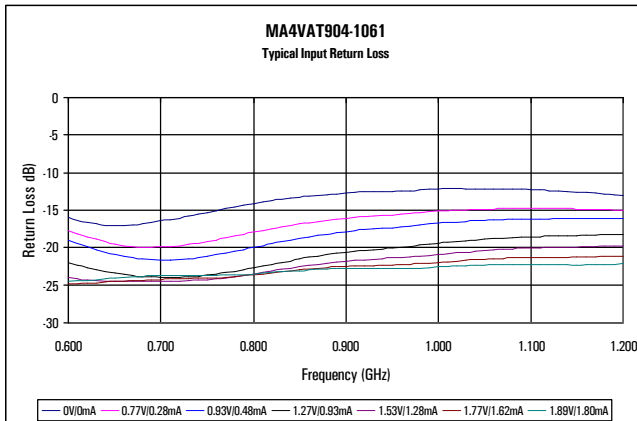

Typical IIP3 vs Attenuation Plot

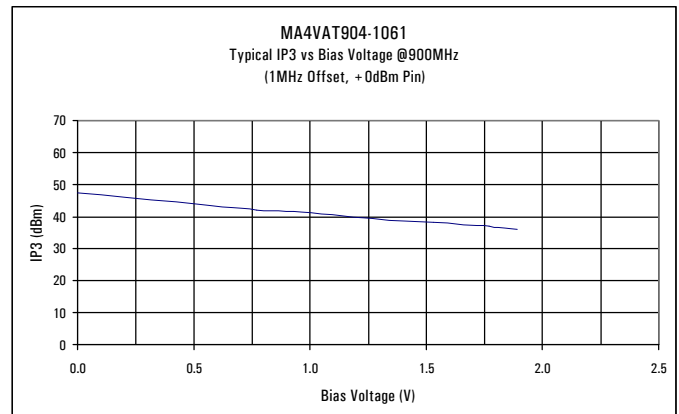

Typical Relative Phase Shift Per Attenuation (Voltage) Plot

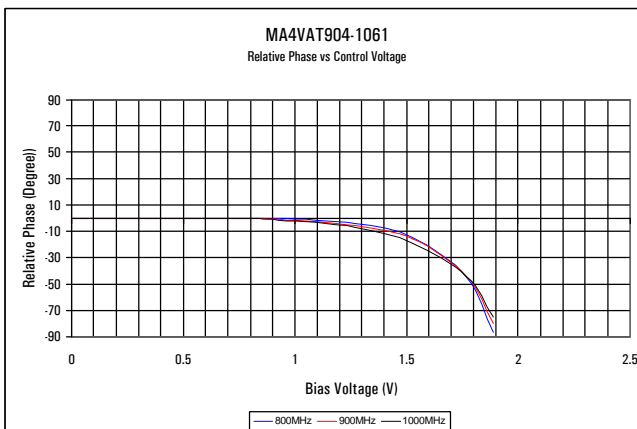

For Reference ONLY:

- Insertion Loss = 0.00 V @ 0.00 mA
- 5dB Attenuation = 0.94 V @ 0.49 mA
- 10dB Attenuation = 1.26 V @ 0.93 mA
- 15dB Attenuation = 1.50 V @ 1.22 mA
- 20dB Anttenuation = 1.77V @ 1.60 mA

High IIP3 PIN Diode Variable Attenuator
0.80-1.0 GHz

MA4VAT904-1061T
V2

Package PIN Designation, External Components, and Equivalent Circuit

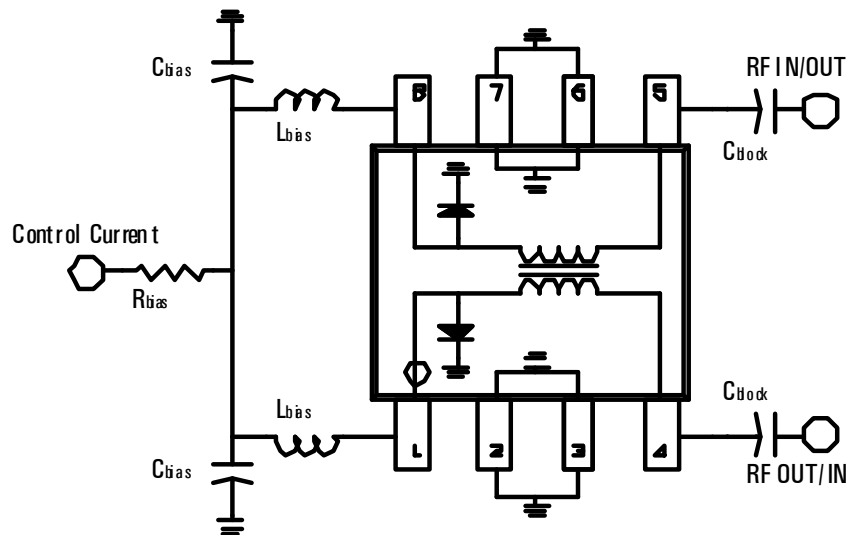
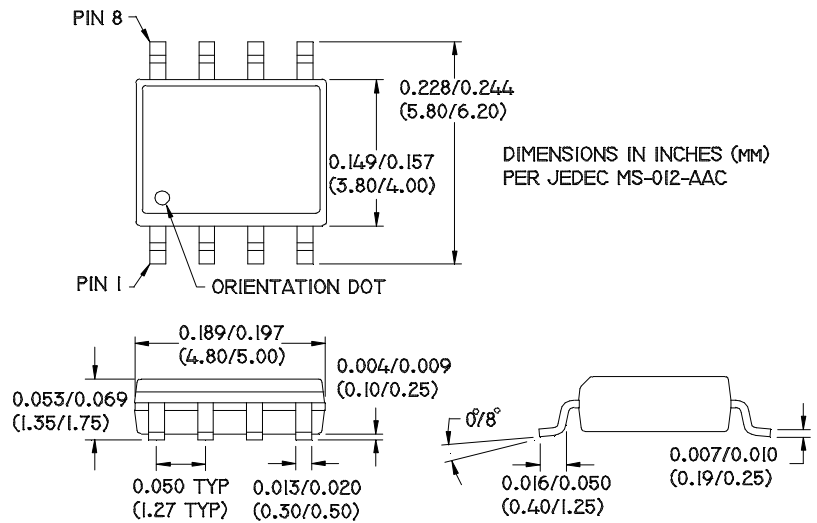

External Bias Components

Rbias= 680 Ohms (1.66 V, @1.50 mA)
Lbias= 150 nH
Cbias =100 pF
Cblock =100 pF