

Tous droits strictement réservés. Reproduction ou communication à des tiers interdite sous quelque forme que ce soit sans autorisation écrite du propriétaire. Propriété de c FCI. Droits de reproduction FCI.

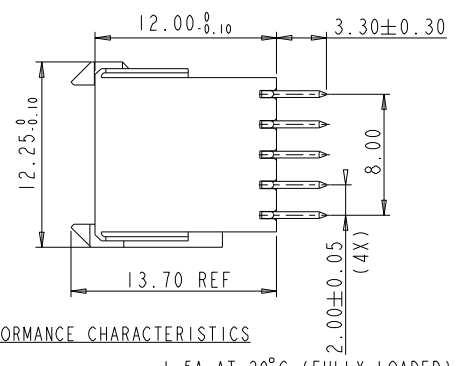

**FCI**

All rights strictly reserved. Reproduction or issue to third parties in any form whatever is not permitted without written authority from the proprietor. Property of FCI. Copyright FCI.

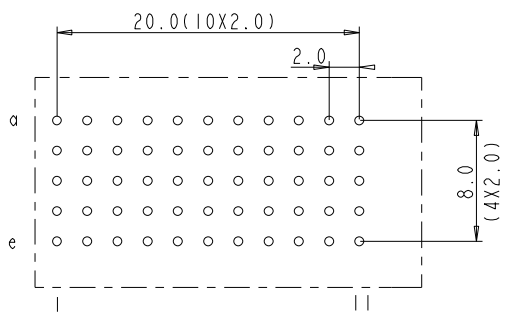
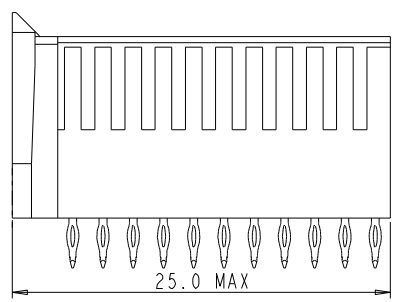
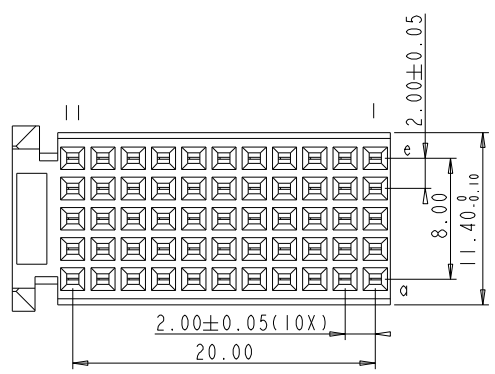

**PERFORMANCE CHARACTERISTICS**

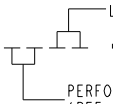
- CURRENT RATING : 1.5A AT 20°C (FULLY LOADED)
- CURRENT RATING : 1 A AT 70°C (FULLY LOADED)
- RATED VOLTAGE : 500 V AC (CONT /CONT)
- OPERATING TEMPERATURE : -55°C TO 125°C
- CONTACT RESISTANCE 20 MΩ MAX
- INSERTION FORCE : 0.75N MAX/CONT
- EXTRACTION FORCE : 0.15N MIN/CONT
- INSULATION RESISTANCE : 10<sup>4</sup> MΩ MIN

- NOTES**
1. "  " LEAD FREE INDICATOR : LF=LEAD FREE  
 "  " PERFORMANCE LEVEL INDICATOR (REF DWG NO.BSC .201844.003)
  2. THIS PRODUCT IS CSA APPROVED.  
 THIS PRODUCT IS UL RECOGNIZED.
  3. FOR RECOMMENDED PTH DIMENSIONS REFER DRAWING :BS.A.201572.001
  4. THIS PRODUCT (LF) MEETS EUROPEAN UNION DIRECTIVES AND OTHER COUNTRY REGULATIONS AS DESCRIBED IN GS-22-008

rev	ecn no	dr	date
A	CONVERSION REVISION 00	KN	14-09-01
B	104-0114	Al ex B	27.11.04
C	DG05-0278	Kason	02-08-05
-	-	-	-
-	-	-	-
-	-	-	-
-	-	-	-

Material		Spec ref		
Mat code		tolerance IDEC#0,2 IDEC 2DEC#0,1 2DEC ANGLESET* HOEKEN	projection	MM
Heatreat				
Plating/Finish			size A4	Scale 2.000
Dr M.Pret	31-10-97	Product family MILLIPACS		
Eng		Model Name		ECN DG05-0278
Chr		Model Revision		REL Level
Appr				
<b>FCI</b>	title	MILLIPACS 2/TYPE C(W/O LOC.PEG) / NO SHIELDING		Rev. C
Pro/E file	catalog	dwg no	BSC201907008	
PDM: Rev-C		HM2S30PE5100		STATUS: Released
		CUSTOMER DRAWING		sheet 1 of 1
Printed: Sep 30, 2005				