

M210x Series

5x7 mm, 3.3/2.5/1.8 Volt, LVPECL/LVDS/CML, Clock Oscillator



Ordering Information

	M210	0	6	8	B	P	N	00.0000	MHz
Product Series									
Supply Voltage									
0: 3.3 V	1: 2.5 V								
2: 1.8 V									
Temperature Range									
2: -40°C to +85°C (see Note 1)									
6: -20°C to +70°C									
Stability									
4: ±50 ppm	3: 100 ppm								
8: ±20 ppm									
Enable/Disable									
B: Enable High (pin 1)	G: Enable High (pin 2)								
S: Enable Low (pin 1)	M: Enable Low (pin 2)								
U: No Enable/Disable									
Logic Type									
P: LVPECL	L: LVDS								
M: CML									
Package/Lead Configuration									
N: 5x7 mm Leadless									
Frequency (customer specified)									

Features:

- Featuring *QiK Chip™* Technology
- Superior Jitter Performance (comparable to SAW based)
- Frequencies from 150 MHz to 1.4 GHz
- Designed for a short 2 week cycle time

Applications:

- Telecommunications such as SONET / SDH / DWDM / FEC / SERDES / OC-3 thru OC-192
- Wireless base stations / WLAN / Gigabit Ethernet
- Avionic flight controls and military communications

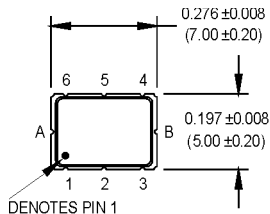

DENOTES PIN 1

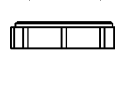

ACTUAL SIZE



All dimensions in inches (mm).



PIN 1 ENABLE

- Pad1: Enable/Disable
- Pad2: N/C
- Pad3: Ground
- Pad4: Output Q (LVPECL, LVDS, CML)
- Pad5: Output \bar{Q} (LVPECL, LVDS, CML)
- Pad6: Vcc
- PadA: Do not connect!
- PadB: Do not connect!
- PadC: Do not connect!

PIN 2 ENABLE

- Pad1: N/C
- Pad2: Enable/Disable
- Pad3: Ground
- Pad4: Output Q (LVPECL, LVDS, CML)
- Pad5: Output \bar{Q} (LVPECL, LVDS, CML)
- Pad6: Vcc
- PadA: Do not connect!
- PadB: Do not connect!
- PadC: Do not connect!

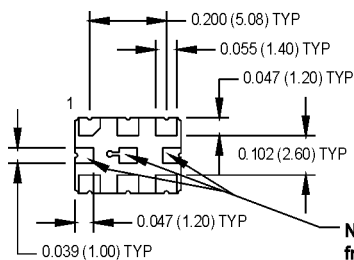

NOTE: These 3 pads must be isolated from any traces or vias appearing beneath this port.

SUGGESTED SOLDER PAD LAY OUT

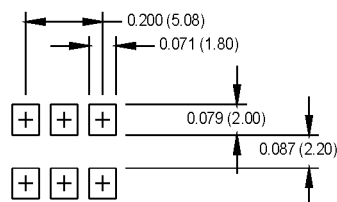

MtronPTI reserves the right to make changes to the product(s) and service(s) described herein without notice. No liability is assumed as a result of their use or application.

Please see www.mtronpti.com for our complete offering and detailed datasheets. Contact us for your application specific requirements: MtronPTI 1-800-762-8800.

Revision: 8-16-06

M210x Series

5x7 mm, 3.3/2.5/1.8 Volt, LVPECL/LVDS/CML, Clock Oscillator



PARAMETER	Symbol	Min.	Typ.	Max.	Units	Condition/Notes	
Frequency Range	F	150		1400	MHz	See Note 2	
Operating Temperature	T _A	(See ordering information)					See Note 1
Storage Temperature	T _S	-55		+125	°C		
Frequency Stability	ΔF/F	(See ordering information)					See Note 3
Aging							
1st Year		-3		+3	ppm		
Thereafter (per year)		-1		+1	ppm		
Supply Voltage	V _{cc}	1.71	1.8	1.89	V		
		2.375	2.5	2.625	V		
		3.135	3.3	3.465	V		
Input Current	I _{cc}			125	mA	LVPECL/LVDS/CML	
Load		50 Ohms to (V _{cc} - 2) V _{dc} 100 Ohm differential load				See Note 4 LVPECL Waveform LVDS/CML Waveform	
Symmetry (Duty Cycle)		45		55	%	@ 50% of waveform	
Output Skew			TBD				
Differential Voltage		350	425 TBD	500	mVppd	LVDS CML	
Common Mode Output Voltage	V _{cm}		1.2		V	LVDS	
Logic "1" Level	V _{oh}	V _{cc} - 1.02			V	LVPECL	
Logic "0" Level	V _{ol}			V _{cc} - 1.63	V	LVPECL	
Rise/Fall Time	T _r /T _f		0.23	0.50	ns	@ 20/80% LVPECL	
Enable Function		80% V _{cc} min. or N/C: output active 20% V _{cc} max.: output disables to high-Z				Output Option B or G	
		20% V _{cc} max.: output active 80% V _{cc} min.: output disables to high-Z				Output Option S or M	
Start up Time			10		ms		
Phase Jitter @ 622.08 MHz	φ _J		0.3		ps RMS	Integrated 12 kHz – 20 MHz	
Phase Noise						@ 622.08 MHz	
10 Hz			-50			dBc/Hz	
100 Hz			-80			dBc/Hz	
1 KHz			-106			dBc/Hz	
10 KHz			-117			dBc/Hz	
100 KHz			-120			dBc/Hz	
1 MHz			-130			dBc/Hz	
10 MHz			-147			dBc/Hz	
40 MHz			-150			dBc/Hz	
Environmental							
Mechanical Shock		Per MIL-STD-202, Method 213, Condition C (100 g's, 6 ms duration, ½ sinewave)					
Vibration		Per MIL-STD-202, Method 201 & 204 (10 g's from 10-2000 Hz)					
Hermeticity		Per MIL-STD-202, Method 112, (1x10 ⁻⁵ atm. cc/s of Helium)					
Thermal Cycle		Per MIL-STD-883, Method 1010, Condition B (-55°C to +125°C, 15 min. dwell, 10 cycles)					
Solderability		Per EIAJ-STD-002					
Soldering Conditions		+240°C max. for 10 secs.					

- Note 1: If the device is powered up below -20°C and then the ambient temperature rises 105°C during normal operation, the output will be interrupted for approximately 2-3 ms. A correction is in process and will be available Q1 2007.
- Note 2: Contact factory for exact frequency availability over 945 MHz
- Note 3: Stability is inclusive of initial tolerance, deviation over temperature, shock, vibration, supply voltage, and aging for one year at 50°C mean ambient temperature.
- Note 4: See Load Circuit Diagram in this Datasheet. Consult factory with nonstandard output load requirements.

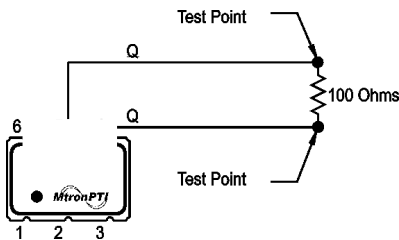

LVDS Load Circuit

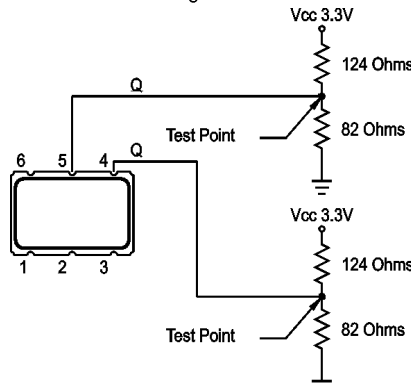

3.3V LVPECL Load Circuit

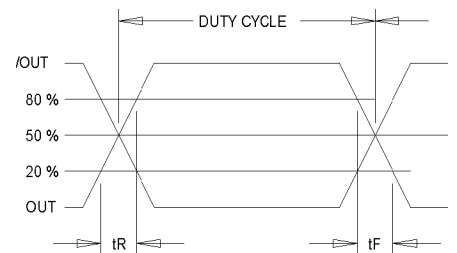

Output Waveform: LVDS/CML/PECL

MtronPTI reserves the right to make changes to the product(s) and service(s) described herein without notice. No liability is assumed as a result of their use or application.

Please see www.mtronpti.com for our complete offering and detailed datasheets. Contact us for your application specific requirements: MtronPTI 1-800-762-8800.