

RoHS COMPLIANT

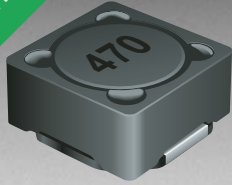

BOURNS®

Features

- Available in E12 values
- Inductance as low as 1.2 μH
- Current rating to 9.2 amps
- Lead free
- RoHS compliant*

Applications

- Input/output of DC/DC converters
- Power supplies for:
 - Portable communication equipment
 - Camcorders
 - LCD TVs
 - Car radios

SRR1260 Series - Shielded SMD Power Inductors

Electrical Specifications

Bourns Part No.	Inductance 100 kHz		Q Typ.	Test Frequency (MHz)	SRF Min. (MHz)	RDC Max. (Ω)	I rms Max. (A)	I sat Typ. (A)
	(μH)	Tol. %						
SRR1260-1R2Y	1.20	± 30	18	7.96	91.1	0.0080	9.20	9.80
SRR1260-2R4Y	2.40	± 30	18	7.96	63.8	0.0115	7.80	8.00
SRR1260-3R5Y	3.50	± 30	22	7.96	37.6	0.0130	7.50	7.60
SRR1260-4R7Y	4.70	± 30	19	7.96	36.7	0.0155	6.80	7.00
SRR1260-6R1Y	6.10	± 30	21	7.96	29.8	0.0170	6.60	6.80
SRR1260-7R6Y	7.60	± 30	16	7.96	27.9	0.0190	6.00	6.20
SRR1260-100M	10.0	± 20	32	2.52	21.0	0.0200	5.50	5.50
SRR1260-120M	12.0	± 20	27	2.52	19.4	0.0230	5.20	5.00
SRR1260-150M	15.0	± 20	25	2.52	17.6	0.0270	5.00	4.60
SRR1260-180M	18.0	± 20	28	2.52	15.5	0.0360	4.20	3.90
SRR1260-220M	22.0	± 20	29	2.52	13.4	0.0430	4.00	3.70
SRR1260-270M	27.0	± 20	26	2.52	12.7	0.0450	3.60	3.30
SRR1260-330M	33.0	± 20	27	2.52	9.97	0.0600	3.00	2.80
SRR1260-390M	39.0	± 20	22	2.52	10.4	0.0700	2.80	2.70
SRR1260-470M	47.0	± 20	22	2.52	7.63	0.0860	2.60	2.50
SRR1260-560M	56.0	± 20	24	2.52	7.92	0.1000	2.30	2.20
SRR1260-680M	68.0	± 20	22	2.52	7.43	0.1100	2.10	2.10
SRR1260-820M	82.0	± 20	25	2.52	6.85	0.1450	1.95	1.90
SRR1260-101M	100.0	± 20	26	0.796	6.07	0.1800	1.70	1.70

General Specifications

Test Voltage.....0.1 V
 Reflow Soldering ...230 °C, 50 sec. max.
 Operating Temperature -40 °C to +125 °C
 (Temperature rise included)
 Storage Temperature...-40 °C to +125 °C
 Resistance to Soldering Heat
260 °C for 10 sec.

Materials

CoreFerrite DR and RI
 WireEnameled copper wire 130
 Terminal.....Cu/Ni/Sn
 Rated Current
Ind. drop 25 % typ. at Isat
 Temperature Rise40 °C max.
 at rated I rms
 Packaging600 pcs. per reel

Product Dimensions

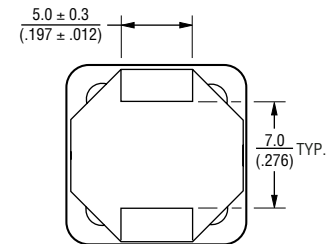
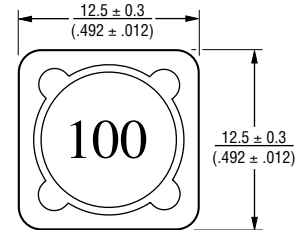

DIMENSIONS: $\frac{\text{MM}}{\text{(INCHES)}}$

Electrical Schematic

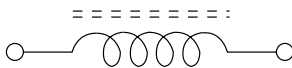

Recommended Layout

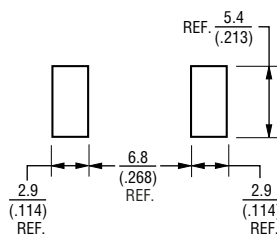

*RoHS Directive 2002/95/EC Jan 27 2003 including Annex
 Specifications are subject to change without notice.
 Customers should verify actual device performance in their specific applications.

SRR1260 Series - Shielded SMD Power Inductors

BOURNS®

Packaging Specifications

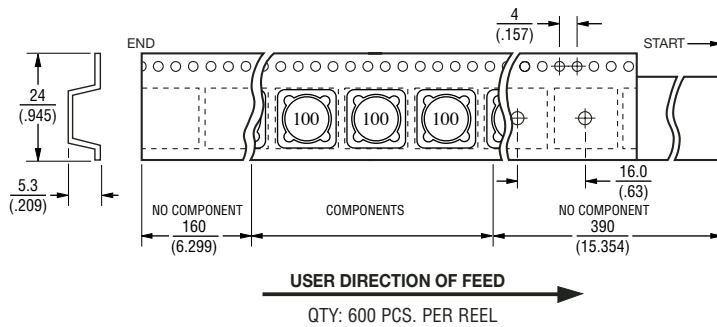
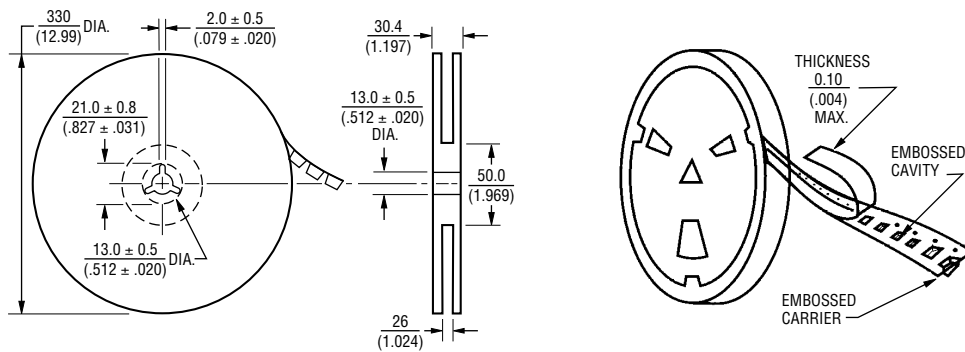

DIMENSIONS: $\frac{\text{MM}}{\text{(INCHES)}}$

REV. 05/05

Specifications are subject to change without notice.
Customers should verify actual device performance in their specific applications.