

Product Description

Stanford Microdevices' NGA-689 is a high performance Gallium Arsenide Heterojunction Bipolar Transistor MMIC Amplifier. Designed with InGaP process technology for improved reliability, a Darlington configuration is utilized for broadband performance up to 5 GHz. The heterojunction increases breakdown voltage and minimizes leakage current between junctions. Cancellation of emitter junction non-linearities results in higher suppression of intermodulation products.

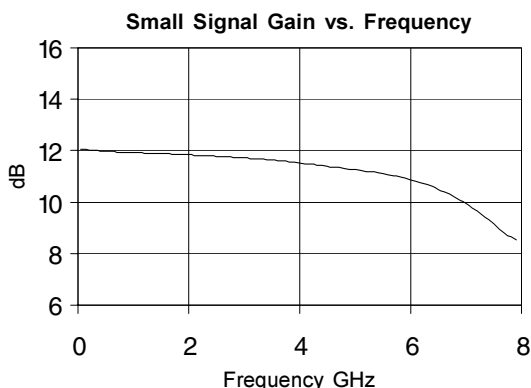

NGA-689

DC-5000 MHz, Cascadable GaAs HBT MMIC Amplifier

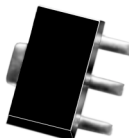

Product Features

- 11.7dB Gain, 18.9 dBm P1dB at 1950MHz
- Cascadable 50 ohm: 1.4:1 VSWR
- Patented GaAs HBT Technology
- Operates from Single Supply
- Low Thermal Resistance Package
- Unconditionally Stable

Applications

- Cellular, PCS, CDPD
- Wireless Data, SONET

Symbol	Parameters: Test Conditions: $Z_0 = 50 \text{ Ohms}$, $I_D = 80 \text{ mA}$, $T = 25^\circ\text{C}$		Units	Min.	Typ.	Max.
P_{1dB}	Output Power at 1dB Compression	$f = 850 \text{ MHz}$	dBm		19.9	
		$f = 1950 \text{ MHz}$	dBm		18.9	
		$f = 2400 \text{ MHz}$	dBm		17.9	
IP_3	Third Order Intercept Point Power out per tone = 0 dBm	$f = 850 \text{ MHz}$	dBm		36.9	
		$f = 1950 \text{ MHz}$	dBm		33.6	
		$f = 2400 \text{ MHz}$	dBm		32.1	
S_{21}	Small Signal Gain	$f = 850 \text{ MHz}$	dB		11.9	
		$f = 1950 \text{ MHz}$	dB		11.7	
		$f = 2400 \text{ MHz}$	dB		11.6	
Bandwidth	Determined by S11 and S22 values		MHz		5000	
S_{11}	Input VSWR	$f = \text{DC} - 5000 \text{ MHz}$	-		1.4:1	
S_{22}	Output VSWR	$f = \text{DC} - 5000 \text{ MHz}$	-		1.4:1	
S_{12}	Reverse Isolation	$f = 850 \text{ MHz}$	dB		19.7	
		$f = 1950 \text{ MHz}$	dB		19.5	
		$f = 2400 \text{ MHz}$	dB		19.4	
NF	Noise Figure	$f = 2000 \text{ MHz}$	dB		6.0	
V_D	Device Voltage		V		5.8	
$R_{th, j-l}$	Thermal Resistance (junction - lead)		$^\circ\text{C/W}$		91	

The information provided herein is believed to be reliable at press time. Stanford Microdevices assumes no responsibility for inaccuracies or omissions. Stanford Microdevices assumes no responsibility for the use of this information, and all such information shall be entirely at the user's own risk. Prices and specifications are subject to change without notice. No patent rights or licenses to any of the circuits described herein are implied or granted to any third party. Stanford Microdevices does not authorize or warrant any Stanford Microdevices product for use in life-support devices and/or systems. Copyright 2000 Stanford Microdevices, Inc. All worldwide rights reserved.

Absolute Maximum Ratings

Operation of this device above any one of these parameters may cause permanent damage.

Bias Conditions should also satisfy the following expression: $I_D V_D (\text{max}) < (T_J - T_{OP})/R_{th,j-l}$

Parameter	Value	Unit
Supply Current	120	mA
Device Voltage	6.7	V
Operating Temperature	-40 to +85	°C
Maximum Input Power	+13	dBm
Storage Temperature Range	-40 to +150	°C
Operating Junction Temperature	+150	°C

Key parameters, at typical operating frequencies:

Parameter	Typical 25°C	Unit	Test Condition
			($I_D = 80\text{mA}$, unless otherwise noted)
500 MHz			
Gain	12.0	dB	Tone spacing = 1 MHz, Pout per tone = 0dBm
Output IP3	37.2	dBm	
Output P1dB	19.9	dBm	
Input Return Loss	19.6	dB	
Reverse Isolation	19.7	dB	
850 MHz			
Gain	11.9	dB	Tone spacing = 1 MHz, Pout per tone = 0dBm
Output IP3	36.9	dBm	
Output P1dB	19.9	dBm	
Input Return Loss	18.5	dB	
Reverse Isolation	19.7	dB	
1950 MHz			
Gain	11.7	dB	Tone spacing = 1 MHz, Pout per tone = 0dBm
Output IP3	33.6	dBm	
Output P1dB	18.9	dBm	
Input Return Loss	16.0	dB	
Reverse Isolation	19.5	dB	
2400 MHz			
Gain	11.6	dB	Tone spacing = 1 MHz, Pout per tone = 0dBm
Output IP3	32.1	dBm	
Output P1dB	17.9	dBm	
Input Return Loss	15.9	dB	
Reverse Isolation	19.4	dB	

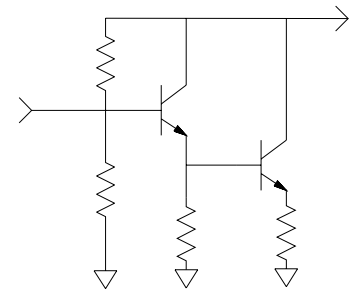
Pin #	Function	Description	Device Schematic
1	RF IN	RF input pin. This pin requires the use of an external DC blocking capacitor chosen for the frequency of operation.	
2	GND	Connection to ground. For best performance use via holes (as close to ground leads as possible) to reduce lead inductance.	
3	RF OUT/ BIAS	RF output and bias pin. Bias should be supplied to this pin through an external series resistor and RF choke inductor. Because DC biasing is present on this pin, a DC blocking capacitor should be used in most applications (see application schematic). The supply side of the bias network should be well bypassed.	
4	GND	Same as Pin 2.	

Application Schematic

Recommended Bias Resistor Values			
Supply Voltage(Vs)	8V	9V	12V
Rbias (Ohms)	27	39	75

For 8V operation or higher, a resistor with a power handling capability of 1/2W or greater is recommended.

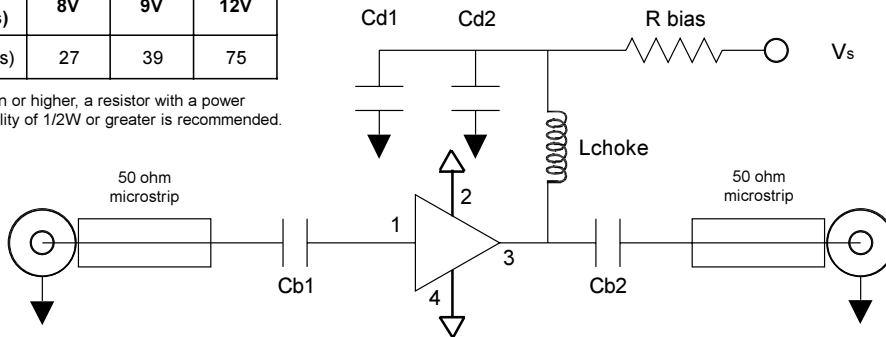

Reference Designator	Function	500 MHz	850 MHz	1950 MHz	2400 MHz
Cb1	DC Blocking	220 pF	100 pF	68 pF	56 pF
Cb2	DC Blocking	220 pF	100 pF	68 pF	56 pF
Cd1	Decoupling	1 uF	1 uF	1 uF	1 uF
Cd2	Decoupling	100 pF	68 pF	22 pF	22 pF
Lchoke	AC Blocking	68 nH	33 nH	22 nH	18 nH

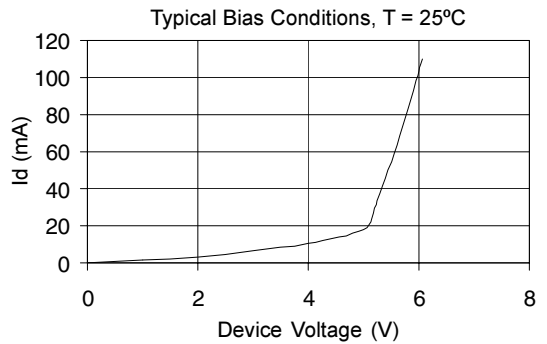
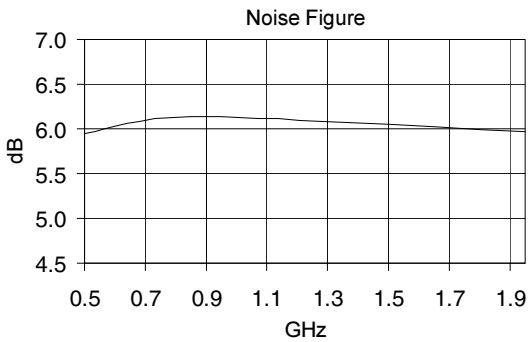
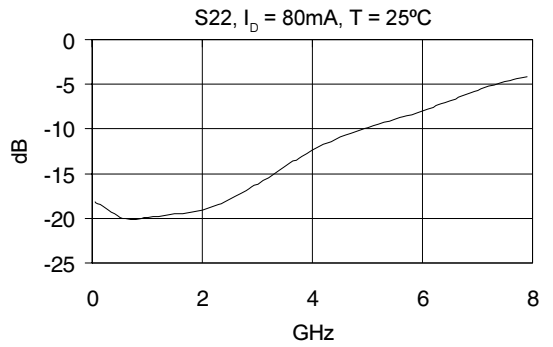
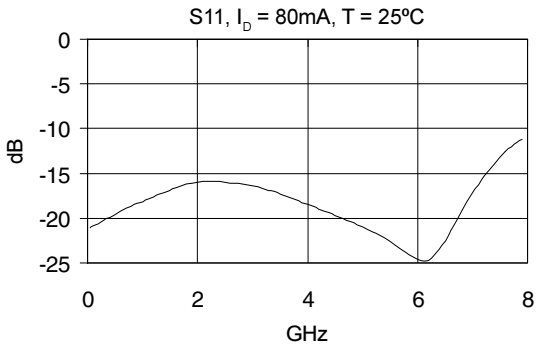
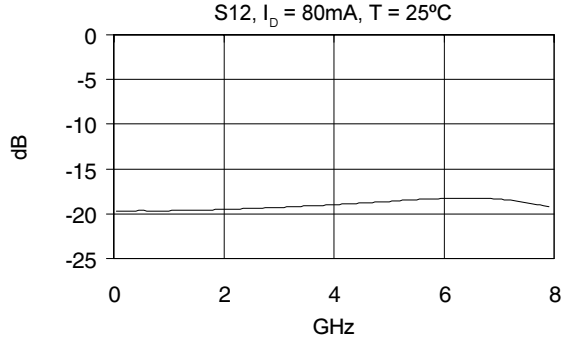
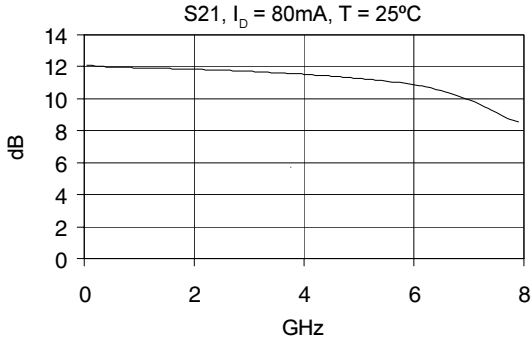

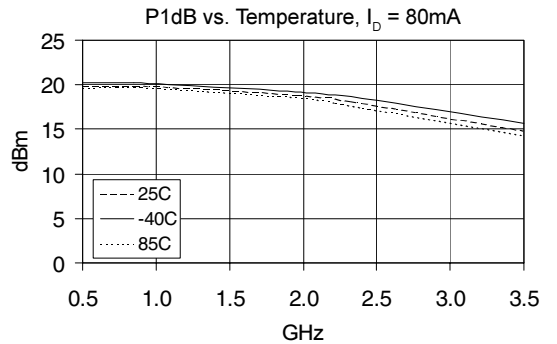
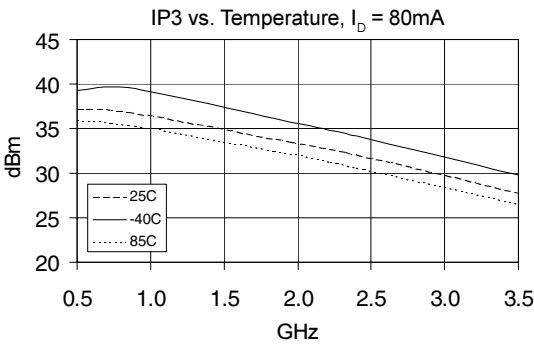
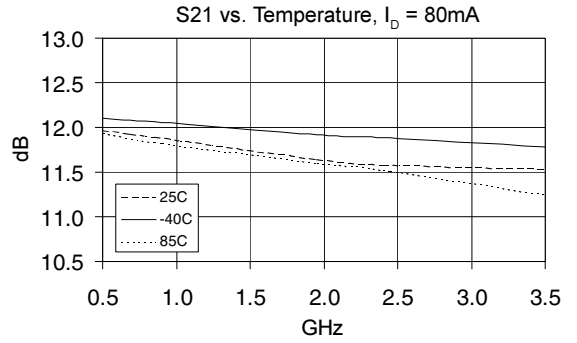
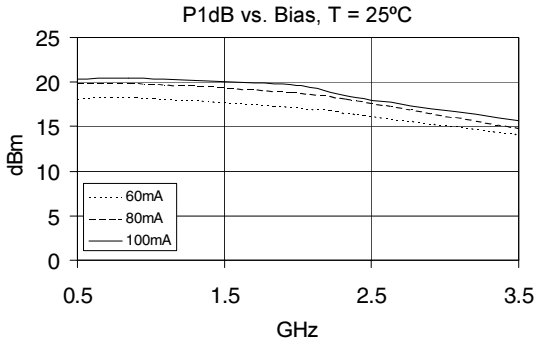
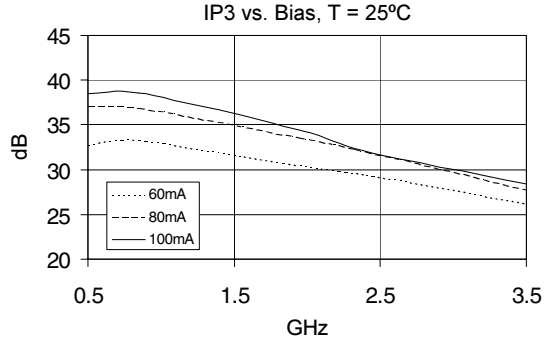
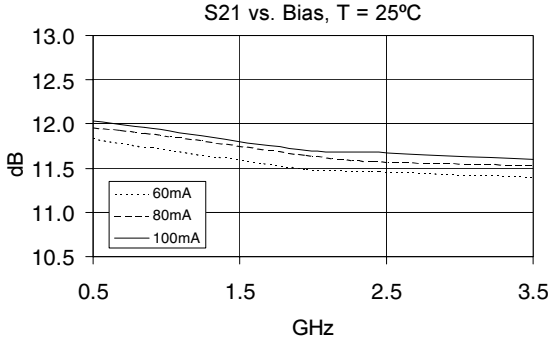

Typical S-Parameters, $I_D = 80mA$ (No external matching, de-embedded to device leads)

Freq GHz	S11			S21			S12			S22	
	mag	Ang	dB	mag	Ang	dB	mag	Ang	mag	Ang	
0.05	0.089	2	12.1	4.014	175	-19.7	0.103	0	0.124	-180	
0.10	0.090	1	12.1	4.009	174	-19.7	0.103	0	0.121	-179	
0.20	0.093	-1	12.0	3.997	173	-19.7	0.104	-2	0.116	-178	
0.30	0.097	-4	12.0	3.985	170	-19.7	0.104	-3	0.111	-177	
0.40	0.101	-7	12.0	3.976	168	-19.7	0.104	-4	0.106	-175	
0.50	0.105	-10	12.0	3.968	165	-19.7	0.104	-6	0.101	-173	
0.60	0.109	-12	12.0	3.964	162	-19.7	0.104	-7	0.099	-171	
0.70	0.114	-14	12.0	3.959	159	-19.7	0.104	-8	0.098	-168	
0.80	0.117	-16	11.9	3.955	156	-19.7	0.104	-9	0.099	-167	
0.90	0.120	-18	11.9	3.950	153	-19.7	0.104	-10	0.100	-165	
1.00	0.124	-20	11.9	3.948	150	-19.7	0.104	-11	0.100	-164	
1.10	0.128	-22	11.9	3.944	147	-19.7	0.104	-12	0.102	-163	
1.20	0.131	-24	11.9	3.940	144	-19.7	0.104	-13	0.103	-162	
1.30	0.135	-26	11.9	3.936	141	-19.6	0.104	-14	0.104	-161	
1.40	0.140	-28	11.9	3.931	138	-19.6	0.104	-16	0.105	-161	
1.50	0.144	-29	11.9	3.928	135	-19.6	0.104	-17	0.106	-161	
1.60	0.148	-31	11.9	3.923	132	-19.6	0.105	-18	0.106	-161	
1.70	0.152	-32	11.9	3.920	129	-19.6	0.105	-19	0.107	-161	
1.80	0.156	-34	11.9	3.916	126	-19.6	0.105	-20	0.108	-162	
1.90	0.158	-36	11.8	3.911	123	-19.5	0.105	-21	0.110	-164	
2.00	0.159	-38	11.8	3.907	120	-19.5	0.106	-22	0.111	-166	
2.20	0.161	-43	11.8	3.898	113	-19.5	0.106	-25	0.116	-172	
2.40	0.160	-47	11.8	3.889	107	-19.4	0.107	-27	0.123	-179	
2.60	0.158	-53	11.8	3.878	101	-19.4	0.107	-30	0.133	174	
2.80	0.155	-57	11.7	3.866	95	-19.3	0.108	-32	0.143	167	
3.00	0.151	-60	11.7	3.854	89	-19.3	0.109	-35	0.156	160	
3.20	0.146	-63	11.7	3.838	83	-19.2	0.109	-37	0.170	154	
3.40	0.140	-66	11.6	3.823	76	-19.2	0.110	-40	0.186	147	
3.60	0.133	-69	11.6	3.805	70	-19.1	0.111	-43	0.204	142	
3.80	0.126	-71	11.6	3.785	64	-19.0	0.112	-45	0.222	136	
4.00	0.120	-74	11.5	3.766	58	-19.0	0.112	-48	0.240	131	
4.20	0.113	-76	11.5	3.745	51	-18.9	0.113	-51	0.258	126	
4.40	0.107	-78	11.4	3.723	45	-18.9	0.114	-54	0.276	121	
4.60	0.101	-80	11.4	3.702	38	-18.8	0.115	-57	0.292	116	
4.80	0.095	-82	11.3	3.679	32	-18.7	0.116	-60	0.308	111	
5.00	0.089	-83	11.3	3.655	26	-18.6	0.117	-63	0.323	106	
5.20	0.084	-84	11.2	3.630	19	-18.5	0.118	-67	0.337	101	
5.40	0.078	-84	11.1	3.602	13	-18.5	0.119	-70	0.351	95	
5.60	0.071	-81	11.1	3.574	6	-18.4	0.120	-74	0.365	89	
5.80	0.064	-75	11.0	3.538	-1	-18.3	0.121	-77	0.382	82	
6.00	0.059	-65	10.9	3.496	-7	-18.3	0.122	-81	0.399	76	
6.50	0.075	-26	10.5	3.349	-25	-18.3	0.122	-91	0.455	58	
7.00	0.138	-11	9.9	3.138	-42	-18.4	0.120	-102	0.521	41	
7.50	0.220	-11	9.1	2.863	-59	-18.8	0.115	-112	0.583	25	
7.90	0.276	-15	8.5	2.672	-70	-19.1	0.110	-119	0.621	16	

Component Tape and Reel Packaging

Tape Dimensions

For 89 Outline

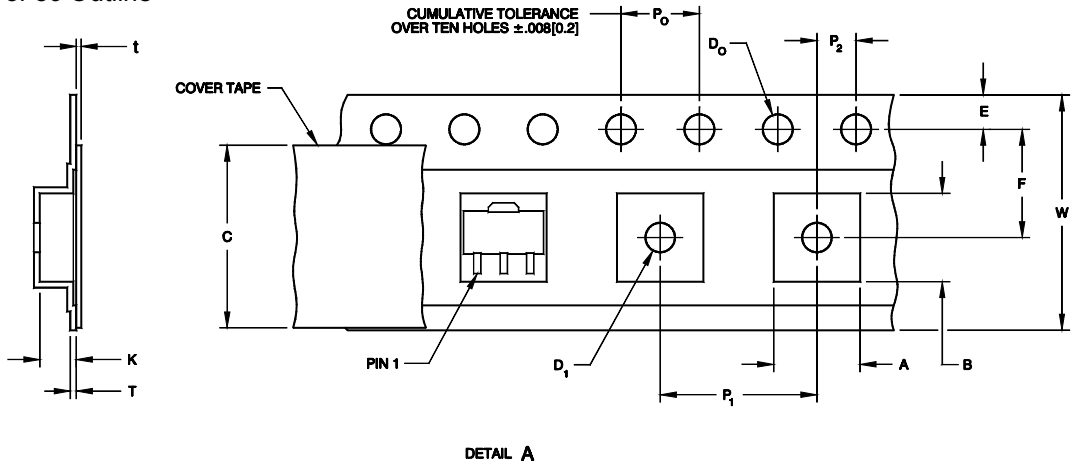

Description		Symbol	Size	
			Millimeters	Inches
Cavity	Length	A	4.91 +/- 0.01	0.19 +/- 0.0004
	Width	B	4.52 +/- 0.01	0.18 +/- 0.0004
	Depth	K	1.90 +/- 0.01	0.07 +/- 0.0004
	Pitch	P ₁	8.00 +/- 0.01	0.31 +/- 0.0004
	Bottom Hole Diameter	D ₁	1.60 +/- 0.10	0.06 +/- 0.004
Perforation	Diameter	D ₀	1.55 +/- 0.05	0.06 +/- 0.002
	Pitch	P ₀	4.00 +/- 0.01	0.16 +/- 0.0004
	Position	E	1.75 +/- 0.01	0.07 +/- 0.0004
Cover Tape	Width	C	9.10 +/- 0.25	0.36 +/- 0.01
	Tape Thickness	t	0.05 +/- 0.01	0.002 +/- 0.0004
Carrier Tape	Width	W	12.0 +/- 0.03	0.47 +/- 0.001
	Thickness	T	0.30 +/- 0.05	0.01 +/- 0.002
Distance	Cavity to Perforation (Width Direction)	F	5.50 +/- 0.10	0.22 +/- 0.0004
	Cavity to Perforation (Length Direction)	P ₂	2.00 +/- 0.10	0.08 +/- 0.0004

Note: Drawing not to scale