

TIAN-MA
MICROELECTRONICS CO., LTD

DEVICE SPECIFICATION FOR LCD MODULE

Model No. TM160160ACCW

Prepared by: 周建	Date: 3/6-99
Checked by: 王彩棠	Date: 3/6-99
Verified by: 許維崇	Date: 4/6-99
Approved by: 孫政民	Date: 7/6-99

To: _____

CUSTOMER'S APPROVAL

DATE _____

By: _____

Presented
By: William
Sell and Market Dep.

TIAN-MA MICRO ELECTRONICS
CO., LTD

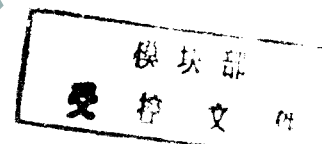

REVISION RECORD

ate	Ref. Page	Revision No.	Revision Items	Check & Approval

受
模块部
受控文件

1 Display Specifications

1.1 Display type: STN

1.2 Display color*:

Display color: Blue/Black

Background color: Black-White

1.3 Polarizer mode: Transflective/Positive

1.4 Viewing Angle: 6:00

1.5 Driving Duty: 1/160

1.6 Backlight: LED(Yellow/Green)

* Color tone is slightly changed by temperature and driving voltage.

2 Mechanical Specifications

2.1 Outline Dimensions: Refer to outline drawing on page: 2

2.2 Dot Matrix: 160×160

2.3 Dot size: 0.34×0.34(mm)

2.4 Dot pitch: 0.38×0.38(mm)

2.5 Weight: 160 g

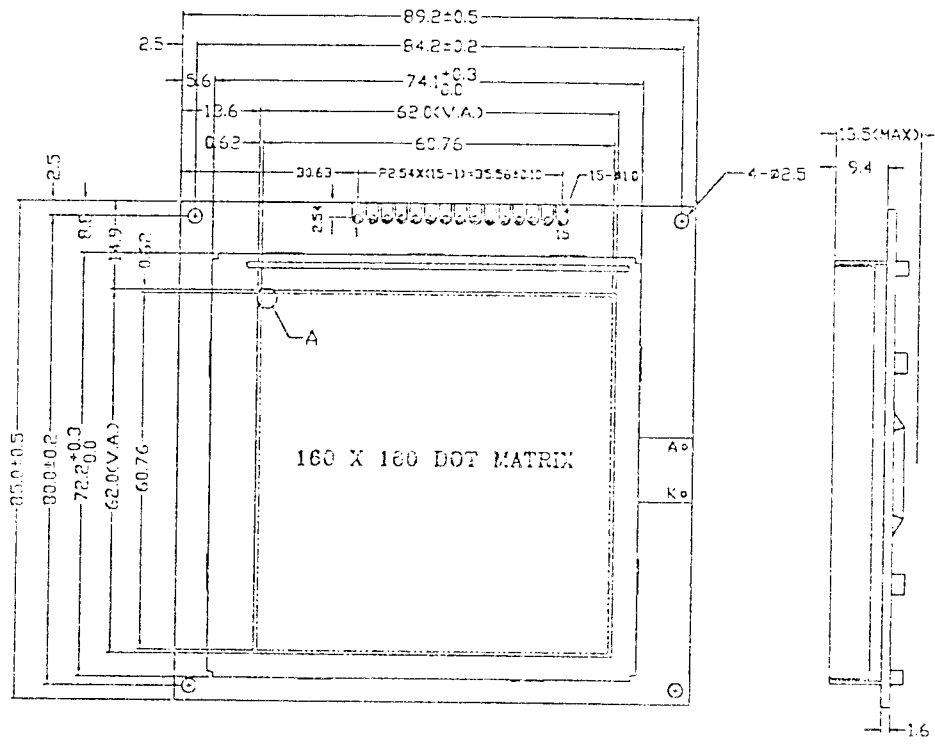

3 Circuit Block Diagram

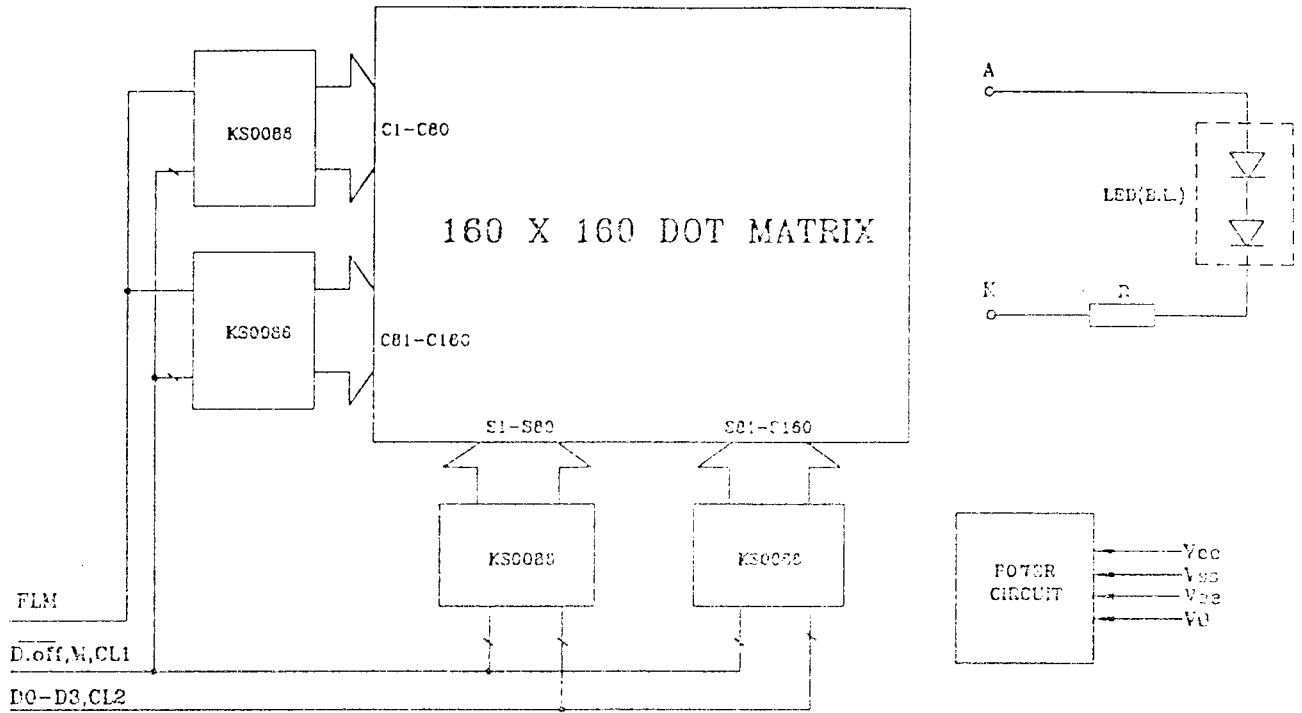

模块部
受控文件

4 Absolute Maximum Ratings

Item	Symbol	Min.	Max.	Unit	Remark
Power Supply Voltage	$V_{DD}-V_{SS}$	4.5	5.5	V	
LCD Driving Voltage	$V_{DD}-V_{EE}$	-	25		
Operating Temperature Range	T_{OP}	-20	+70	°C	No Condensation
Storage Temperature Range	T_{ST}	-30	+80		

5 Electrical Specifications and Instruction Code

5.1 Electrical characteristics

Item	Symbol	Min.	Typ.	Max.	Unit	Remark	
Supply Voltage (Logic)	$V_{DD}-V_{SS}$	4.75	5.0	5.25	V		
Supply Voltage (LCD Drive)	$V_{DD}-V_{EE}$	-	17.0	-	V		
Input Signal Voltage	'H'Level	V_{IH}	$0.8V_{DD}$	-	$V_{DD}+0.3$	V	
	'L'Level	V_{IL}	0	-	$0.2 V_{DD}$	V	
Supply current (Logic)	I_{DD}	-	-	6.0	mA		
Supply current (LCD Drive)	I_{EE}	-	-	3.0	mA		

5.2 Interface Signals

Pin No	Symbol	Level	Description
1	Vss	-	Ground
2	M	H/L	Control signal for A.C driving
3	FLM	H	The FLM signal indicates the beginning of each display cycle
4	CL1	H→L	The CL1 latches the serial data in shift register
5	CL2	H→L	Clock signal for shifting the serial data
6	D3	H/L	Data bit3
7	D2	H/L	Data bit2
8	D1	H/L	Data bit1
9	D0	H/L	Data bit0
10	VEE	-13V	Power supply for LCD driving
11	VDD	+5V	Power supply for logic
12	V0	-	Operation voltage for LCD driving
13	DISPOFF	L	Display off when low level
14	K	0V	Power supply for LED backlight(-)
15	A	+5V	Power supply for LED backlight(+)

模块部
受控文件

5.3 Interface Timing Chart:

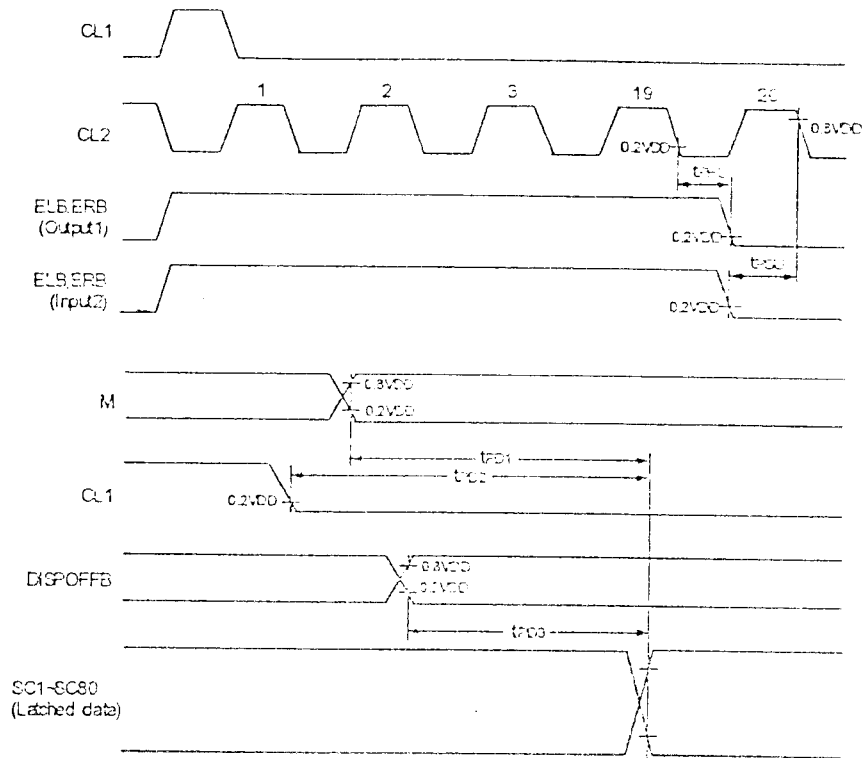

SEGMENT DRIVER APPLICATION

(V_{SS} = 0 V, T_a = -30 ~ +85°C)

Characteristic	Symbol	Test Condition	(1) VDD=5 V ± 10%			(2) VDD=3 V ± 10%			Unit
			MIN	TYP	MAX	MIN	TYP	MAX	
Clock cycle time	t _{cy}	Duty=50%	125	-	-	200	-	-	ns
Clock pulse width	t _{wck}	-	45	-	-	95	-	-	
Clock rise/fall time	t _{RAF}	-	-	-	-	-	-	30	
Data set-up time	t _{DS}	-	30	-	-	65	-	-	
Data hold time	t _{DH}	-	30	-	-	65	-	-	
Clock set-up time	t _{CS}	-	80	-	-	120	-	-	
Clock hold time	t _{CH}	-	80	-	-	120	-	-	
Propagation delay time	t _{PHL}	ELB Output	-	-	60	-	-	125	
		ERB Output	-	-	60	-	-	125	
ELB, ERB set-up time	t _{PSU}	ELB Input	30	-	-	65	-	-	
		ERE Input	30	-	-	65	-	-	
DISPOFFB low pulse width	t _{WDL}	-	1.2	-	-	1.2	-	-	μs
DISPOFFB clear time	t _{CD}	-	100	-	-	100	-	-	ns
M - OUT propagation delay time	t _{PD1}	CL=15 pF	-	-	1.0	-	-	1.2	μs
CL1 - OUT propagation delay time	t _{PD2}		-	-	1.0	-	-	1.2	
DISPOFFB - OUT propagation delay time	t _{PD3}		-	-	1.0	-	-	-	

112 ~~SECRET~~

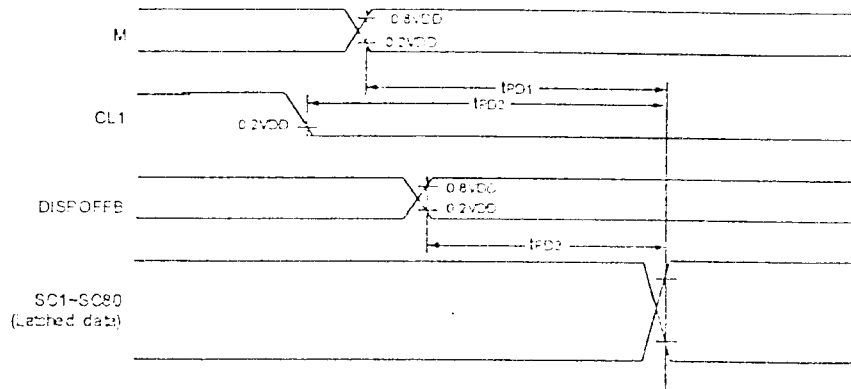

COMMON DRIVER APPLICATION

($V_{SS} = 0V$, $T_a = -30 - +85^{\circ}C$)

Characteristic	Symbol	Test Condition	(1) VDD=5V ± 10%			(2) VDD=3V ± 10%			Unit
			MIN	TYP	MAX	MIN	TYP	MAX	
Clock cycle time	t_{CY}	Duty=50%	250	-	-	500	-	-	ns
Clock pulse width	t_{WCK}	-	45	-	-	90	-	-	
Clock rise/fall time	t_{RAF}	-	-	-	50	-	-	50	
Data set-up time	t_{DS}	-	30	-	-	65	-	-	
Data hold time	t_{DH}	-	30	-	-	65	-	-	
DISPOFFB low pulse width	t_{WDL}	-	1.2	-	-	1.2	-	-	μs
DISPOFFB clear time	t_{CD}	-	100	-	-	100	-	-	ns
Output delay time	t_{DL}	CL=15 pF	-	-	200	-	-	250	μs
M - OUT propagation delay time	t_{PD1}		-	-	1.0	-	-	1.2	
CL1 - OUT propagation delay time	t_{PD2}		-	-	1.0	-	-	1.2	
DISPOFFB - OUT propagation delay time	t_{PD3}		-	-	1.0	-	-	1.2	

模块部

受控文件

6. Optical Characteristics

6.1 Optical Characteristics

Top=25°C

Item	Symbol	Condition	Min.	Typ.	Max.	Unit	Remark
Viewing Angle	θ_x	Cr>2 $\theta_y=0^\circ$	-20	--	35	Deg	
	θ_y						
Contrast Ratio	Cr	$\theta_x=0^\circ$ $\theta_y=0^\circ$	4.0				
Response Time	Turn on	$\theta_x=0^\circ$ $\theta_y=0^\circ$			250	ms	
	Turn off				Toff		

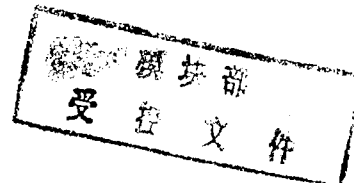

 研 技 部
 受 控 文 件

6.2 Definition of optical characteristics

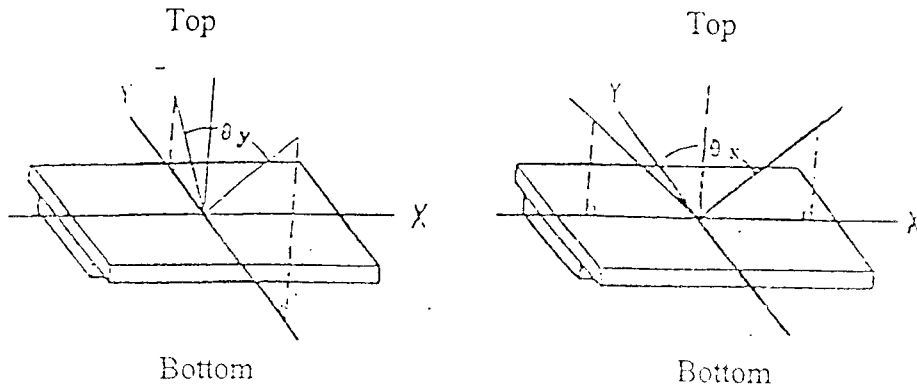
6.2.1 Definition of viewing Angle(see fig. as follow)

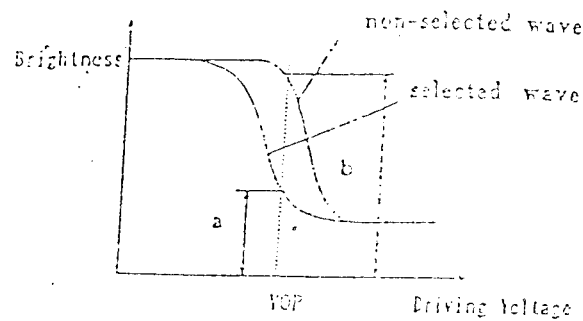

6.2.2 Definition of Contrast Ratio(see fig. as follow)



$$\text{Contrast Ratio} = b / a = \frac{\text{non-selected state brightness}}{\text{selected state brightness}}$$

Measuring Conditions:

- 1) Ambient Temperature: 25 °C ; 2) Frame frequency: 64Hz

6.2.3 Definition of Response time(see fig. as follow)

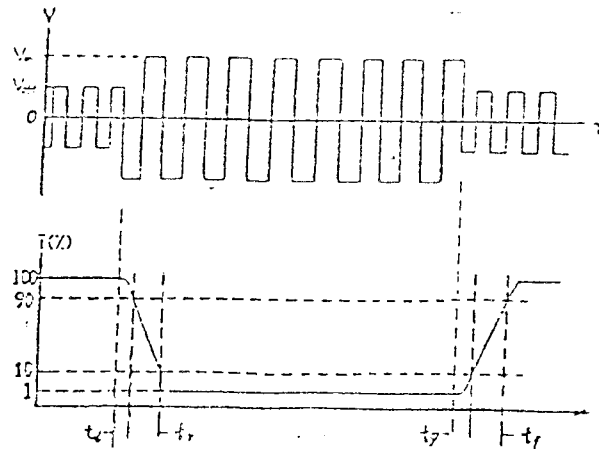

Turn-on time: $t_{on} = t_d + t_r$

Turn-off time: $t_{off} = t_d + t_r$

Measuring Condition:

- 1) Operating Voltage: 17.0V ; 2) Frame frequency: 64Hz

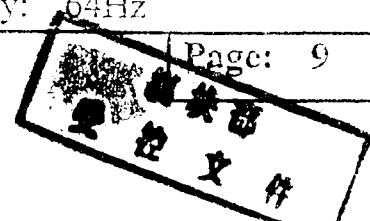

7. Reliability

7.1 Content of Reliability Test

($T_{OP}=25^{\circ}\text{C}$)

No.	Test Item	Content of Test	Test condition
1	High Temperature Storage	Endurance test applying the high storage temperature for a long time	80°C 96H
2	Low Temperature Storage	Endurance test applying the low storage temperature for a long time	-30°C 96H
3	High Temperature Operation	Endurance test applying the electric stress (voltage & current) and the thermal stress to the element for a long time	70°C 96H
4	Low Temperature Operation	Endurance test applying the electric stress under low temperature for a long time	-20°C 96H
5	High Temperature /Humidity Storage	Endurance test applying the high temperature and high humidity storage for a long time	60°C 90%RH 96H
6	Temperature Cycle	Endurance test applying the low and high temperature cycle $-20^{\circ}\text{C} \longleftrightarrow 25^{\circ}\text{C} \longleftrightarrow 60^{\circ}\text{C} \longleftrightarrow -20^{\circ}\text{C}$ 30min 5min 30min 5min $\longleftarrow \hspace{10em} \longrightarrow$ 1 cycle	-30°C/80°C 10 cycles
7	Vibration Test (package state)	Endurance test applying the vibration during transportation	10Hz~150Hz, 50m/s ² , 40min
8	Shock Test (package state)	Endurance test applying the shock during transportation	Half-sinewave, 100m/s ² , 11ms
9	Atmospheric Pressure Test	Endurance test applying the atmospheric pressure during transportation by air	25Kpa 16H

7.2 Failure Judgment Criterion

Criterion Item	Test Item No.									Failure Judgement Criterion
	1	2	3	4	5	6	7	8	9	
Basic Specification	0	0	0	0	0	0	0	0	0	Out of the basic Specification
Electrical specification	0	0	0	0	0					Out of the electrical specification
Mechanical Specification							0	0		Out of the mechanical specification
Optical Characteristic	0	0	0	0	0	0			0	Out of the optical specification
Remark	Basic specification = Optical specification - Mechanical specification									

8 Precautions for use of LCD Modules

8.1 Handling Precautions

- 8.1.1 The display panel is made of glass. Do not subject it to a mechanical shock by dropping it from a high place, etc.
- 8.1.2 If the display panel is damaged and the liquid crystal substance inside it leaks out, be sure not to get any in your mouth, if the substance comes into contact with your skin or clothes, promptly wash it off using soap and water.
- 8.1.3 Do not apply excessive force to the display surface or the adjoining areas since this may cause the color tone to vary.
- 8.1.4 The polarizer covering the display surface of the LCD module is soft and easily scratched. Handle this polarizer carefully.
- 8.1.5 If the display surface is contaminated, breathe on the surface and gently wipe it with a soft dry cloth. If still not completely clear, moisten cloth with one of the following solvents:
- Isopropyl alcohol
 - Ethyl alcohol
- Solvents other than those mentioned above may damage the polarizer. Especially, do not use the following:
- Water
 - Ketone
 - Aromatic solvents
- 8.1.6 Do not attempt to disassemble the LCD Module.
- 8.1.7 If the logic circuit power is off, do not apply the input signals.
- 8.1.8 To prevent destruction of the elements by static electricity, be careful to maintain an optimum work environment.
- a. Be sure to ground the body when handling the LCD Modules.
 - b. Tools required for assembly, such as soldering irons, must be properly ground.
 - c. To reduce the amount of static electricity generated, do not conduct assembly and other work under dry conditions.
 - d. The LCD Module is coated with a film to protect the display surface. Be care when peeling off this protective film since static electricity may be generated.

受 控 品

8.2 Storage precautions

8.2.1 When storing the LCD modules, avoid exposure to direct sunlight or to the light of fluorescent lamps.

8.2.2 The LCD modules should be stored under the storage temperature range. If the LCD modules will be stored for a long time, the recommend condition is:

temperature : $0^{\circ}\text{C} \sim 40^{\circ}\text{C}$

relatively humidity: $\leq 80\%$

8.2.3 The LCD modules should be stored in the room without acid, alkali and harmful gas.

8.3 The LCD modules should be no falling and violent shocking during transportation, and also should avoid excessive press, water, damp and sunshine.

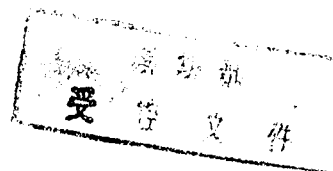

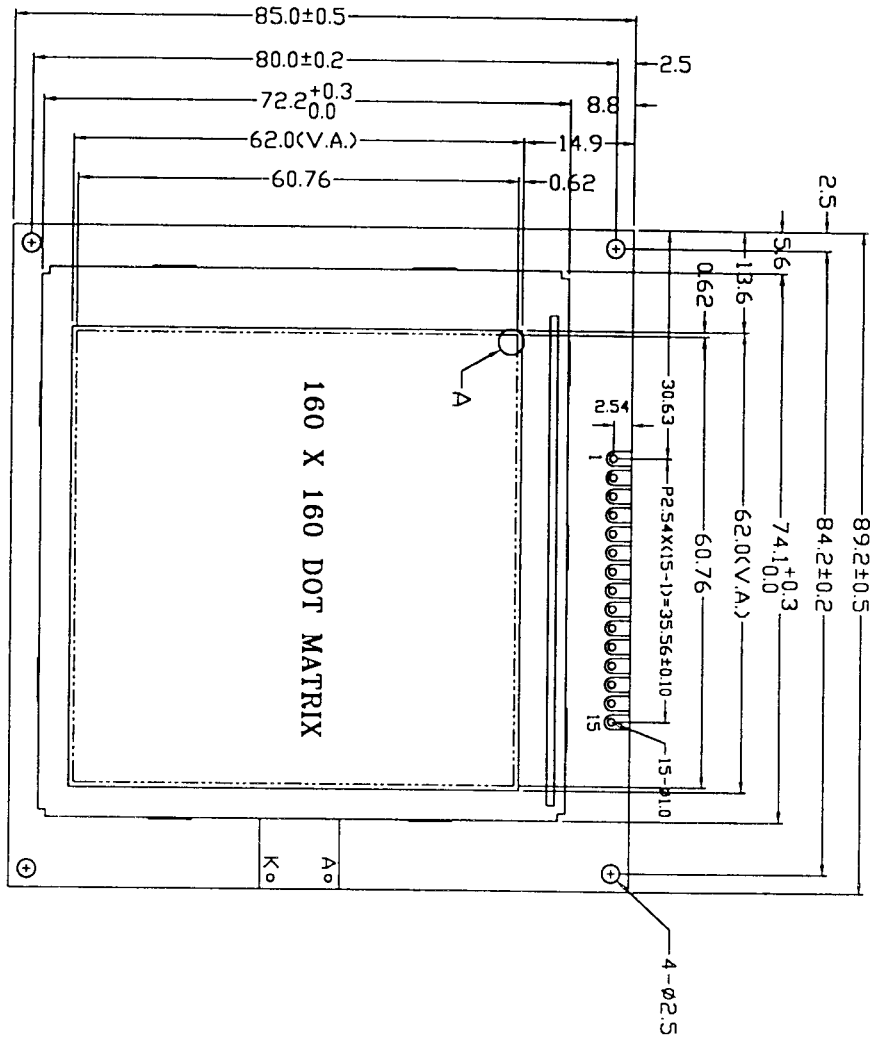

- NOTES:
- 1.DISPLAY TYPE: FSTN
 - 2.VIEWING DIRECTION: 6:00
 - 3.POLARIZER MODE: TRANSPARENT/POSITIVE
 - 4.OPERATING TEMP: -20°C--+70°C
 - 5.STORAGE TEMP: -30°C--+80°C
 - 6.ALL UNMARKED TOLERANCES: ±0.3
 - 7.DRIVE METHOD: DUTY=1/160 BIAS=1/14
 - 8.BLCD OPERATING VOLTAGE: 17.0V
 - 9.BACKLIGHT TYPE:LED/YELLOW-GREEN
 - 10.DRIVER: KS0086
 - 11.WITHOUT CONTROLLER
 - 12.CONNECTOR: ESQ-115-23-SS(SAMTEC)
 - 13.BEZEL: PAINT COATING(WHITE)

1	VSS
2	M
3	FLM
4	CL1
5	CL2
6	D3
7	D2
8	D1
9	D0
10	VEE
11	VDD
12	V0
13	D.off
14	K
15	A

DETAIL A:

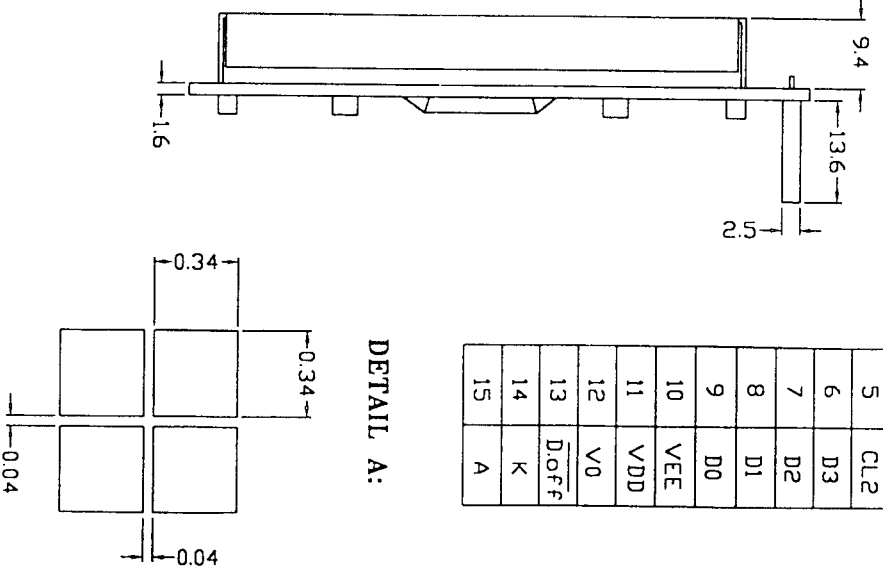

TIAN-MA MICROELECTRONICS CO.

22/F., HAKOBU Building, Sherman Road, Central, Shenzhen, C

DRAWN BY:		TITLE: TM160160ACCW1	SCALE: 1:1
CHECKED BY:		DWG NO: G-1	UNIT: mm
APPROVED BY:		DWG NAME: TM160160ACCW1	SHEET NO:
CONFIRMED BY:			