



## Dual N-Channel 30-V (D-S) MOSFET with Schottky Diode

PRODUCT SUMMARY			
	V <sub>DS</sub> (V)	r <sub>DS(on)</sub> (Ω)	I <sub>D</sub> (A)
Channel-1	30	0.012 @ V <sub>GS</sub> = 10 V	9.6
		0.018 @ V <sub>GS</sub> = 4.5 V	7.8
Channel-2		0.010 @ V <sub>GS</sub> = 10 V	13.5
		0.0110 @ V <sub>GS</sub> = 4.5 V	12.8

SCHOTTKY PRODUCT SUMMARY		
V <sub>DS</sub> (V)	V <sub>SD</sub> (V) Diode Forward Voltage	I <sub>F</sub> (A)
30	0.53 V @ 3 A	2.0

### FEATURES

- TrenchFET® Power MOSFET

### APPLICATIONS

- DC-DC Converters
  - Game Stations
  - Video Graphics

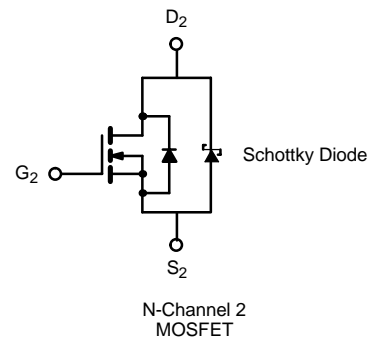
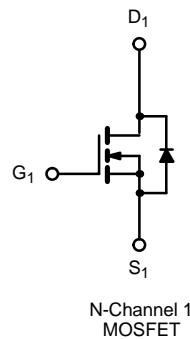
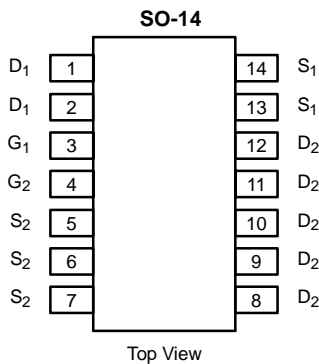

ABSOLUTE MAXIMUM RATINGS (T <sub>A</sub> = 25 °C UNLESS OTHERWISE NOTED)							
Parameter	Symbol	Channel-1		Channel-2		Unit	
		10 secs	Steady State	10 secs	Steady State		
Drain-Source Voltage	V <sub>DS</sub>	30				V	
Gate-Source Voltage	V <sub>GS</sub>	± 20		± 12			
Continuous Drain Current (T <sub>J</sub> = 150°C) <sup>a</sup>	I <sub>D</sub>	T <sub>A</sub> = 25 °C	9.6	7.3	13.5	9.9	A
		T <sub>A</sub> = 70 °C	7.7	5.8	10.8	7.6	
Pulsed Drain Current	I <sub>DM</sub>	40		50		A	
Continuous Source Current (Diode Conduction) <sup>a</sup>	I <sub>S</sub>	1.8	1.04	2.73	1.33		
Maximum Power Dissipation <sup>a</sup>	P <sub>D</sub>	T <sub>A</sub> = 25 °C	2	1.14	3.0	1.47	W
		T <sub>A</sub> = 70 °C	1.28	0.73	1.9	0.94	
Operating Junction and Storage Temperature Range	T <sub>J</sub> , T <sub>stg</sub>	-55 to 150				°C	

THERMAL RESISTANCE RATINGS									
Parameter	Symbol	Channel-1		Channel-2		Schottky		Unit	
		Typ	Max	Typ	Max	Typ	Max		
Maximum Junction-to-Ambient <sup>a</sup>	R <sub>thJA</sub>	t ≤ 10 sec	50	62.5	34	42	40	48	°C/W
		Steady-State	90	110	70	85	76	93	
Maximum Junction-to-Foot (Drain)	R <sub>thJC</sub>	33	40	17	22	21	26		

Notes

a. Surface Mounted on 1" x 1" FR4 Board.

**MOSFET SPECIFICATIONS ( $T_J = 25^\circ\text{C}$  UNLESS OTHERWISE NOTED).**

Parameter	Symbol	Test Condition	Min	Typ <sup>a</sup>	Max	Unit	
<b>Static</b>							
Gate Threshold Voltage	$V_{GS(th)}$	$V_{DS} = V_{GS}, I_D = 250 \mu\text{A}$	Ch-1	0.8	1.40	2.00	V
			Ch-2	0.8	1.35	1.90	
Gate-Body Leakage	$I_{GSS}$	$V_{DS} = 0 \text{ V}, V_{GS} = \pm 20 \text{ V}$	Ch-1			100	nA
		$V_{DS} = 0 \text{ V}, V_{GS} = \pm 12 \text{ V}$	Ch-2			100	
Zero Gate Voltage Drain Current	$I_{DSS}$	$V_{DS} = 24 \text{ V}, V_{GS} = 0 \text{ V}$	Ch-1			1	$\mu\text{A}$
			Ch-2			100	
		$V_{DS} = 24 \text{ V}, V_{GS} = 0 \text{ V}, T_J = 85^\circ\text{C}$	Ch-1			15	
			Ch-2			4000	
On-State Drain Current <sup>b</sup>	$I_{D(on)}$	$V_{DS} = 5 \text{ V}, V_{GS} = 10 \text{ V}$	Ch-1	20			A
			Ch-2	30			
Drain-Source On-State Resistance <sup>b</sup>	$r_{DS(on)}$	$V_{GS} = 10 \text{ V}, I_D = 9.6 \text{ A}$	Ch-1		0.010	0.012	$\Omega$
		$V_{GS} = 10 \text{ V}, I_D = 13.5 \text{ A}$	Ch-2		0.007	0.010	
		$V_{GS} = 4.5 \text{ V}, I_D = 7.8 \text{ A}$	Ch-1		0.015	0.018	
		$V_{GS} = 4.5 \text{ V}, I_D = 12.8 \text{ A}$	Ch-2		0.0085	0.0110	
Forward Transconductance <sup>b</sup>	$g_{fs}$	$V_{DS} = 15 \text{ V}, I_D = 9.6 \text{ A}$	Ch-1		25		S
		$V_{DS} = 15 \text{ V}, I_D = 13.5 \text{ A}$	Ch-2		56		
Diode Forward Voltage <sup>b</sup>	$V_{SD}$	$I_S = 1.8 \text{ A}, V_{GS} = 0 \text{ V}$	Ch-1		0.7	1.1	V
		$I_S = 2.73 \text{ A}, V_{GS} = 0 \text{ V}$	Ch-2		0.485	0.53	
<b>Dynamic<sup>a</sup></b>							
Total Gate Charge	$Q_g$	Channel-1 $V_{DS} = 15 \text{ V}, V_{GS} = 5 \text{ V}, I_D = 9.6 \text{ A}$  Channel-2 $V_{DS} = 15 \text{ V}, V_{GS} = 5 \text{ V}, I_D = -13.5 \text{ A}$	Ch-1		11.5	17	nC
			Ch-2		40	60	
Gate-Source Charge	$Q_{gs}$		Ch-1		3		
			Ch-2		10		
Gate-Drain Charge	$Q_{gd}$		Ch-1		4.5		
			Ch-2		8.8		
Gate Resistance	$R_G$	Ch-1		1.45		$\Omega$	
		Ch-2		0.8			
Turn-On Delay Time	$t_{d(on)}$	Channel-1 $V_{DD} = 15 \text{ V}, R_L = 15 \Omega$ $I_D \cong 1 \text{ A}, V_{GEN} = 10 \text{ V}, R_G = 6 \Omega$  Channel-2 $V_{DD} = 15 \text{ V}, R_L = 15 \Omega$ $I_D \cong 1 \text{ A}, V_{GEN} = 10 \text{ V}, R_G = 6 \Omega$	Ch-1		10	20	ns
Rise Time	$t_r$		Ch-2		17	26	
			Ch-1		5	10	
Turn-Off Delay Time	$t_{d(off)}$		Ch-2		14	21	
			Ch-1		30	60	
Fall Time	$t_f$		Ch-2		102	155	
			Ch-1		10	20	
Source-Drain Reverse Recovery Time	$t_{rr}$		$I_F = 1.8 \text{ A}, di/dt = 100 \text{ A}/\mu\text{s}$	Ch-1		30	
		$I_F = 2.73 \text{ A}, di/dt = 100 \mu\text{A}/\mu\text{s}$	Ch-2		40	65	

## Notes

- a. Guaranteed by design, not subject to production testing.  
 b. Pulse test; pulse width  $\leq 300 \mu\text{s}$ , duty cycle  $\leq 2\%$ .

**SCHOTTKY SPECIFICATIONS ( $T_J = 25^\circ\text{C}$  UNLESS OTHERWISE NOTED)**

Parameter	Symbol	Test Condition	Min	Typ	Max	Unit
Forward Voltage Drop	$V_F$	$I_F = 3 \text{ A}$		0.485	0.53	V
		$I_F = 3 \text{ A}, T_J = 125^\circ\text{C}$		0.42	0.42	
Maximum Reverse Leakage Current	$I_{rm}$	$V_r = 30 \text{ V}$		0.008	0.100	mA
		$V_r = 30 \text{ V}, T_J = 75^\circ\text{C}$		0.4	5	
		$V_r = -30 \text{ V}, T_J = 125^\circ\text{C}$		6.5	20	
Junction Capacitance	$C_T$	$V_r = 15 \text{ V}$		102		pF



**TYPICAL CHARACTERISTICS (25°C UNLESS NOTED)**

**CHANNEL-1**

**Output Characteristics**

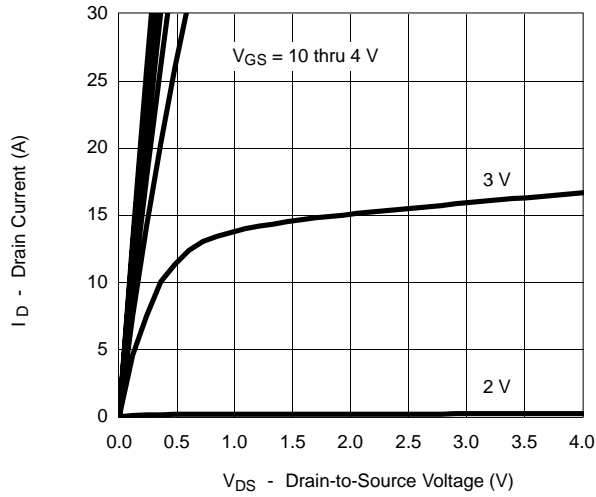

**Transfer Characteristics**

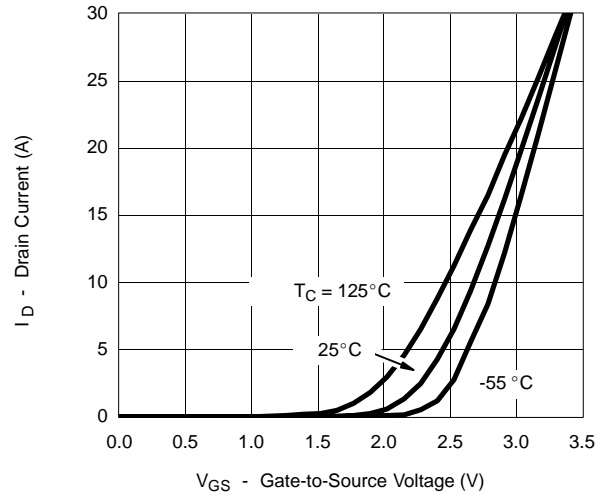

**On-Resistance vs. Drain Current**

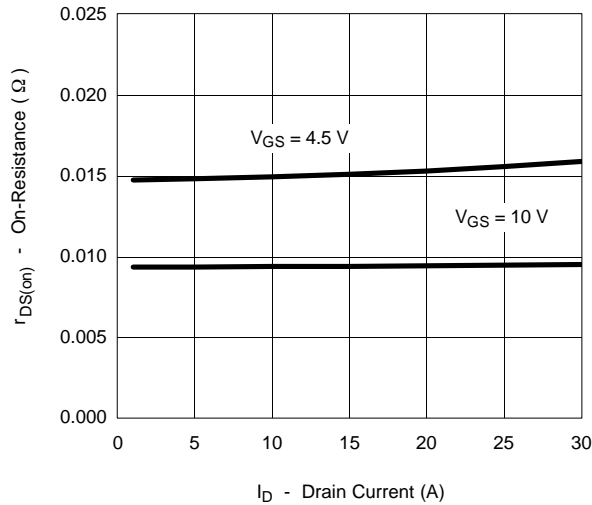

**Capacitance**

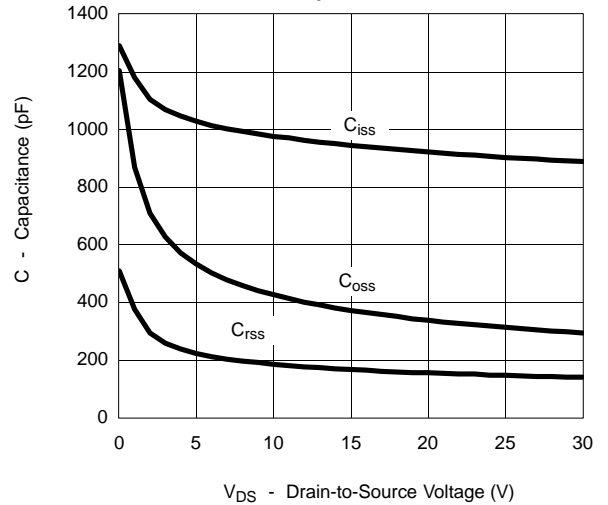

**Gate Charge**

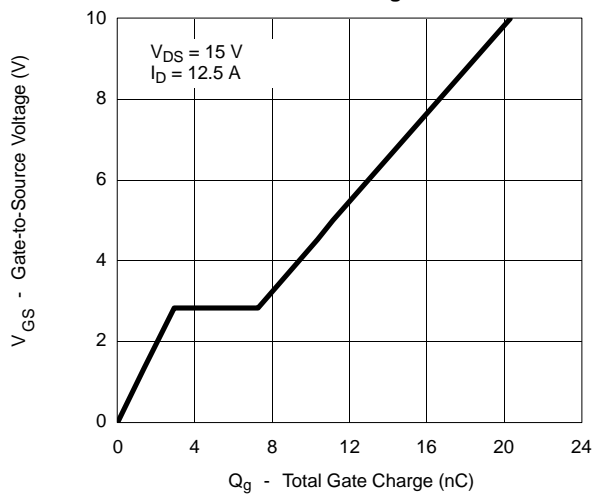

**On-Resistance vs. Junction Temperature**

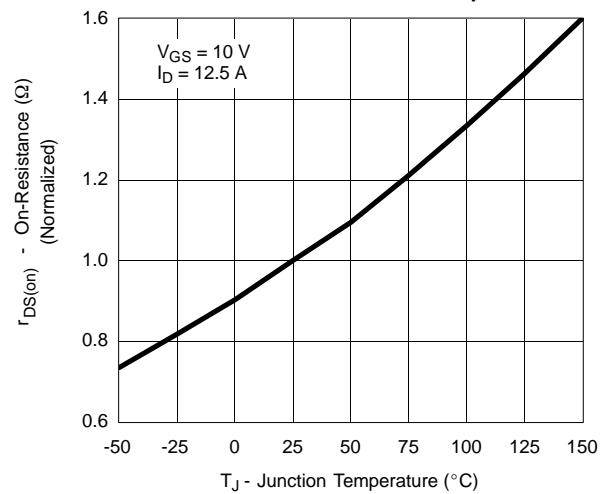

### TYPICAL CHARACTERISTICS (25 °C UNLESS NOTED)

### CHANNEL-1

Source-Drain Diode Forward Voltage

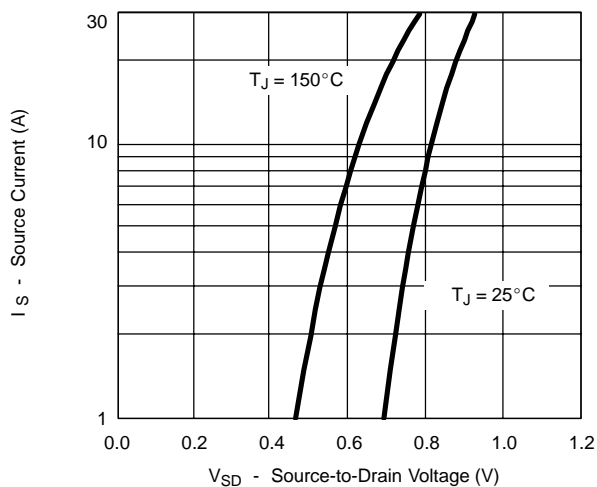

On-Resistance vs. Gate-to-Source Voltage

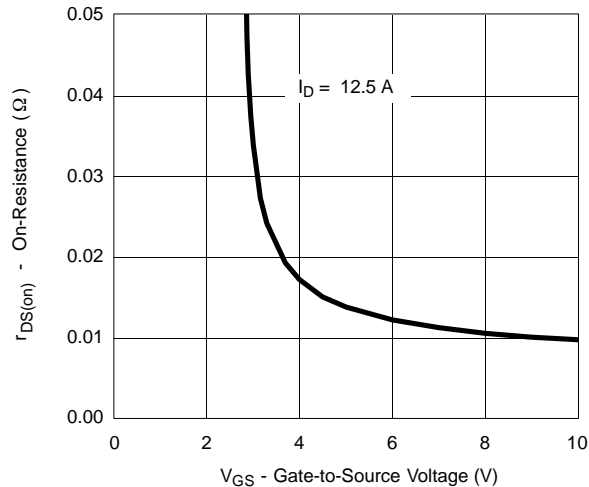

Threshold Voltage

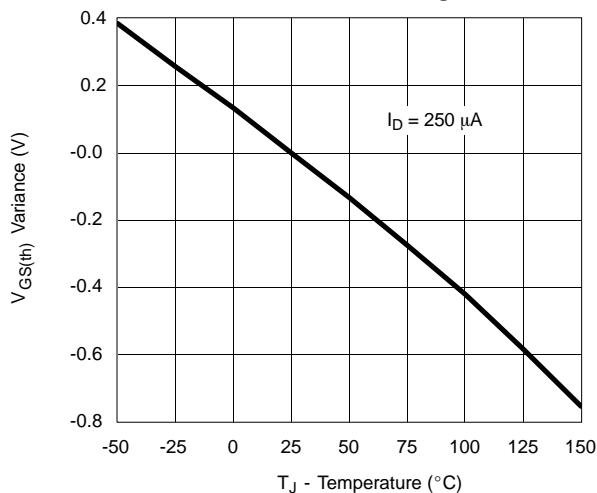

Single Pulse Power

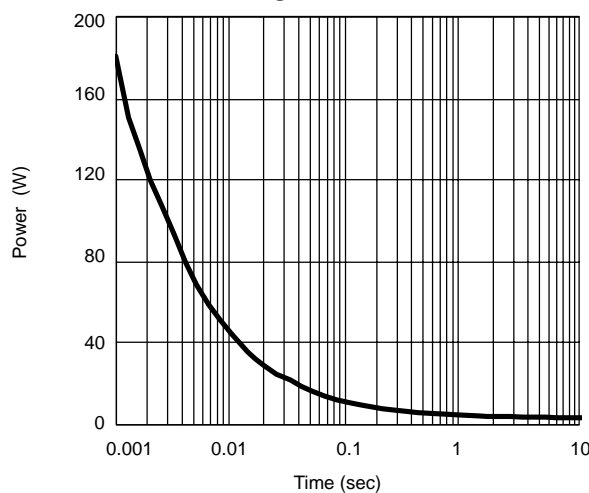

Normalized Thermal Transient Impedance, Junction-to-Ambient

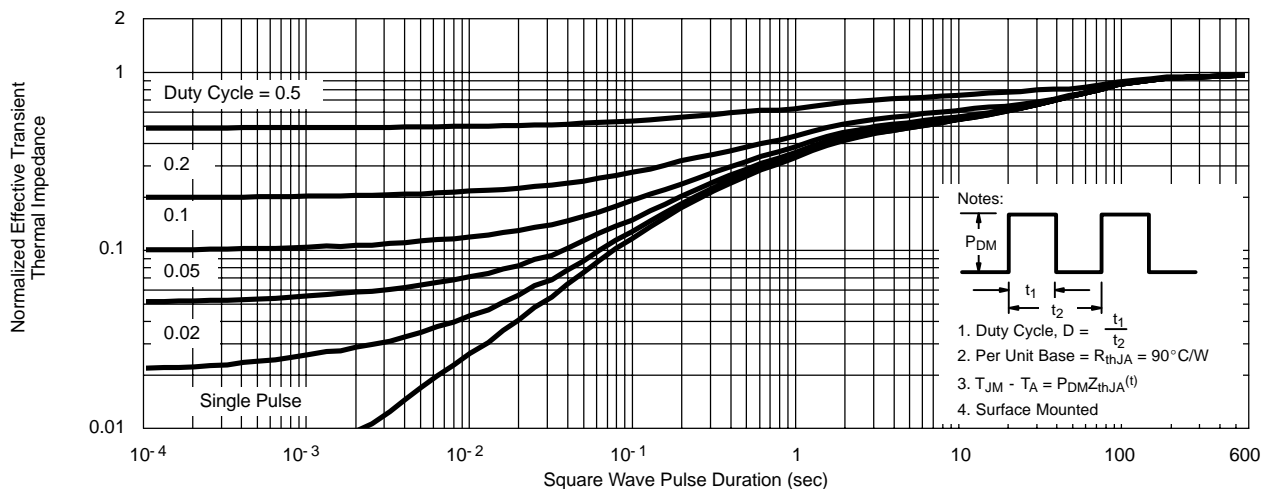



TYPICAL CHARACTERISTICS (25 °C UNLESS NOTED)

CHANNEL-1

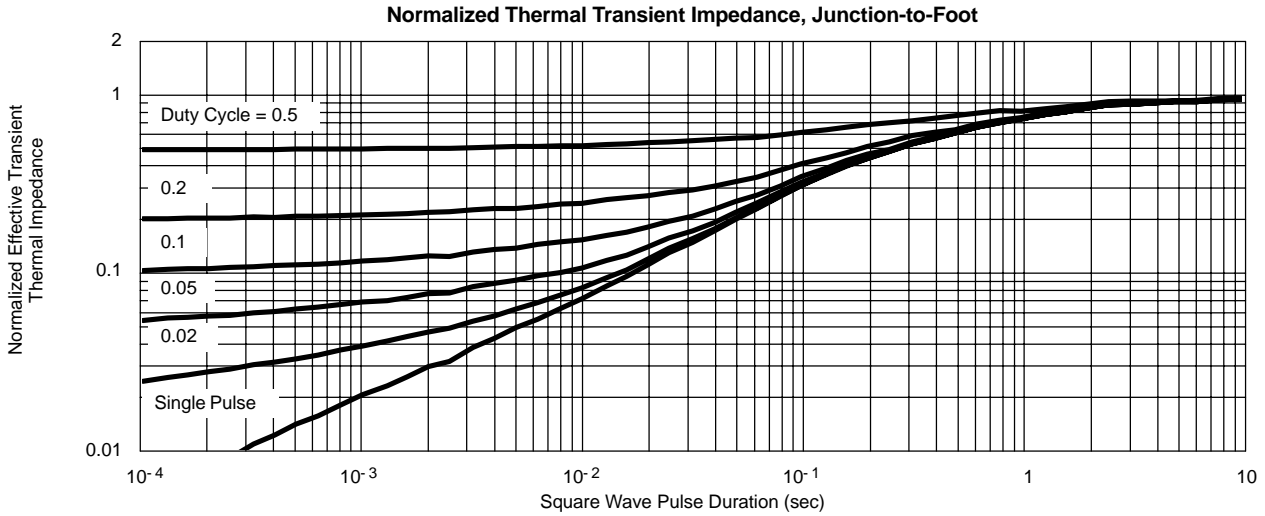

TYPICAL CHARACTERISTICS (25 °C UNLESS NOTED)

CHANNEL-2

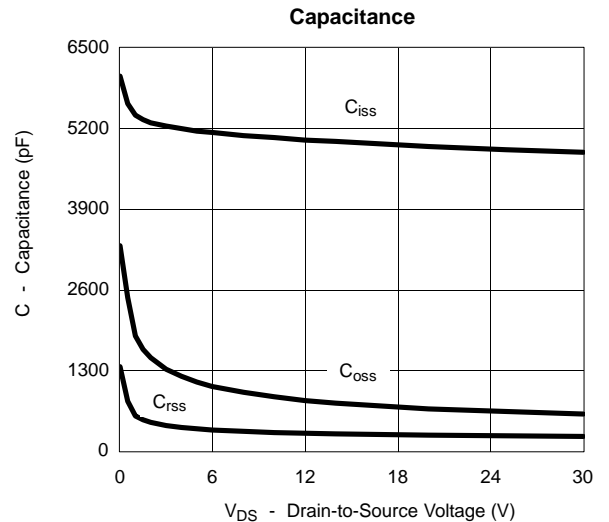
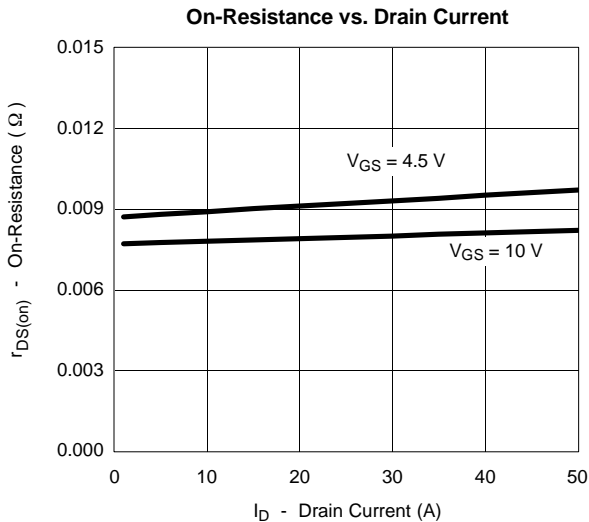
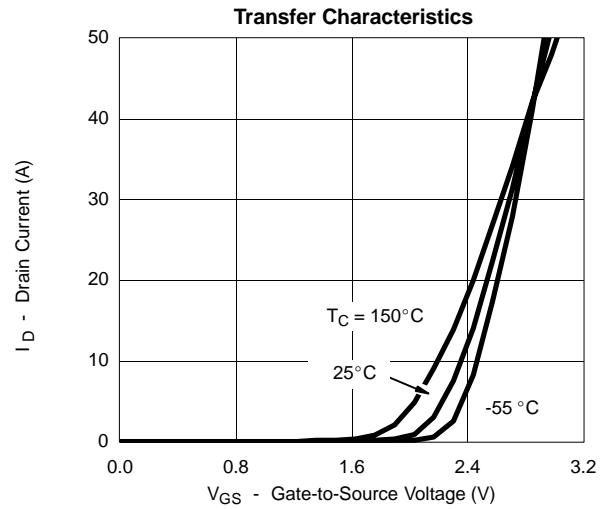
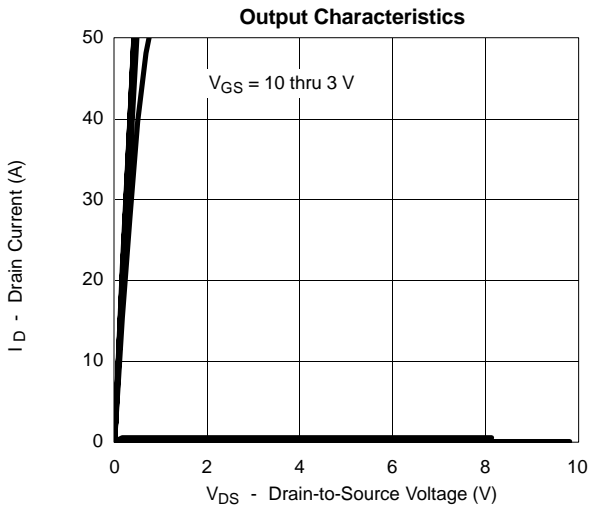

**TYPICAL CHARACTERISTICS (25 °C UNLESS NOTED)**

**CHANNEL-2**

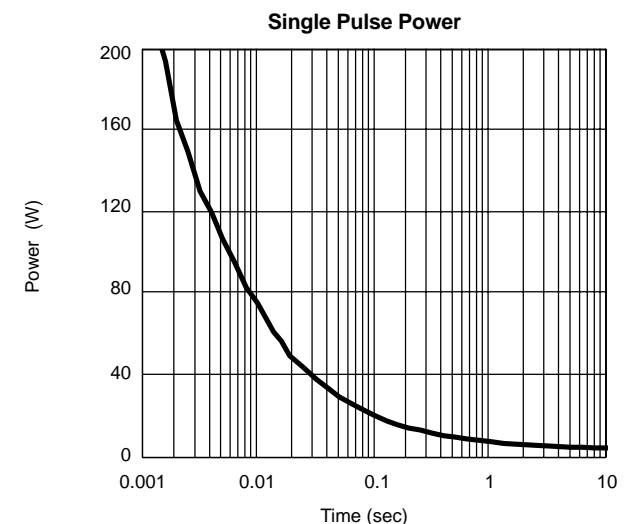
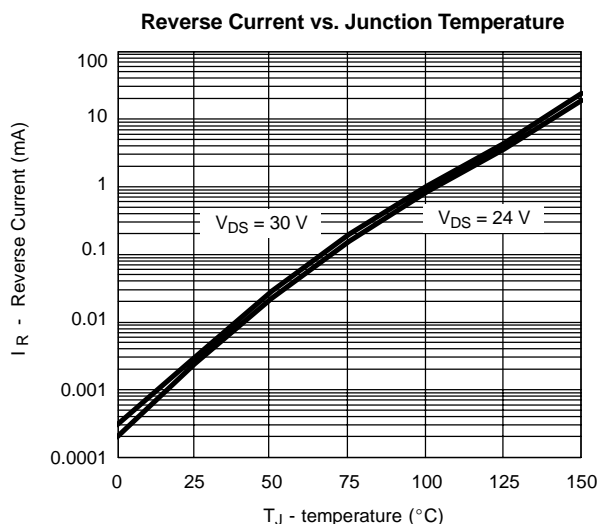
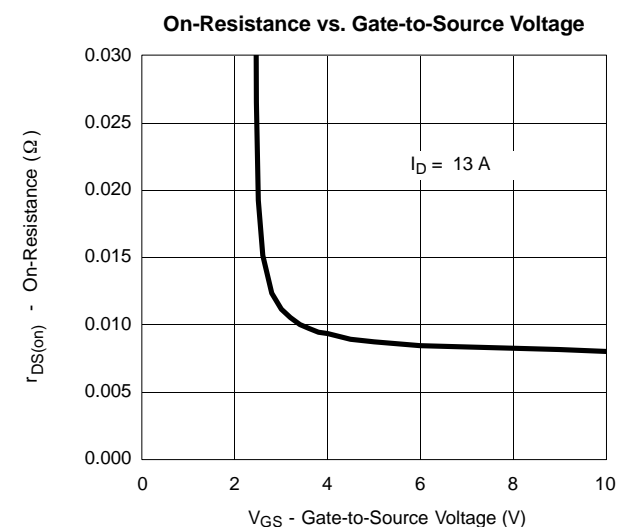
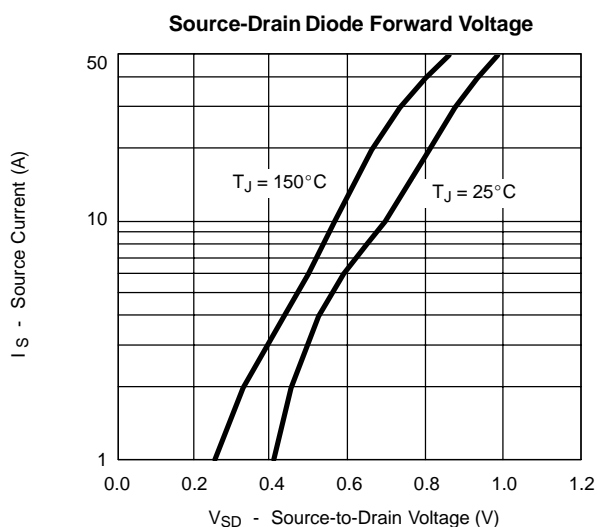
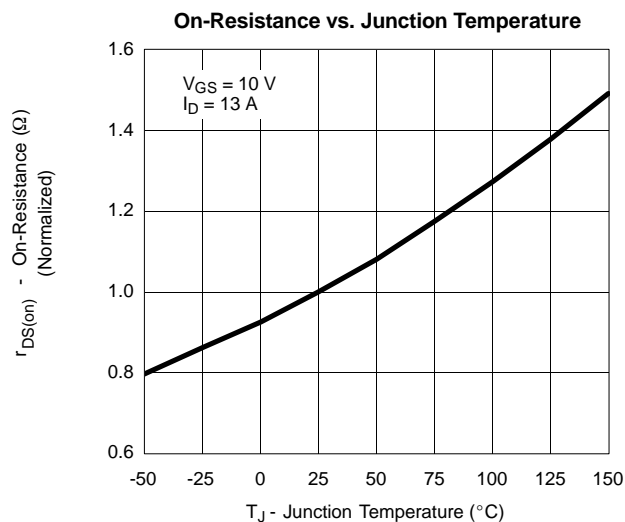
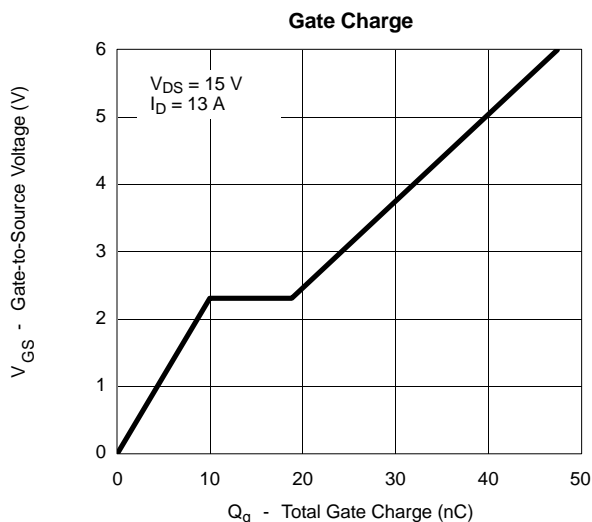



**TYPICAL CHARACTERISTICS (25°C UNLESS NOTED) CHANNEL-2**

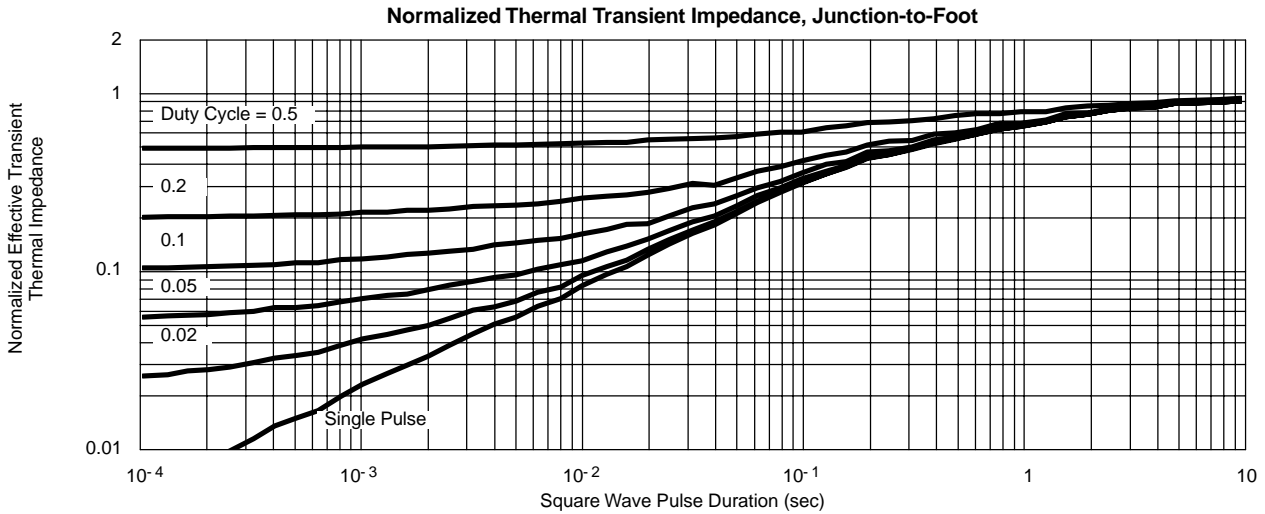
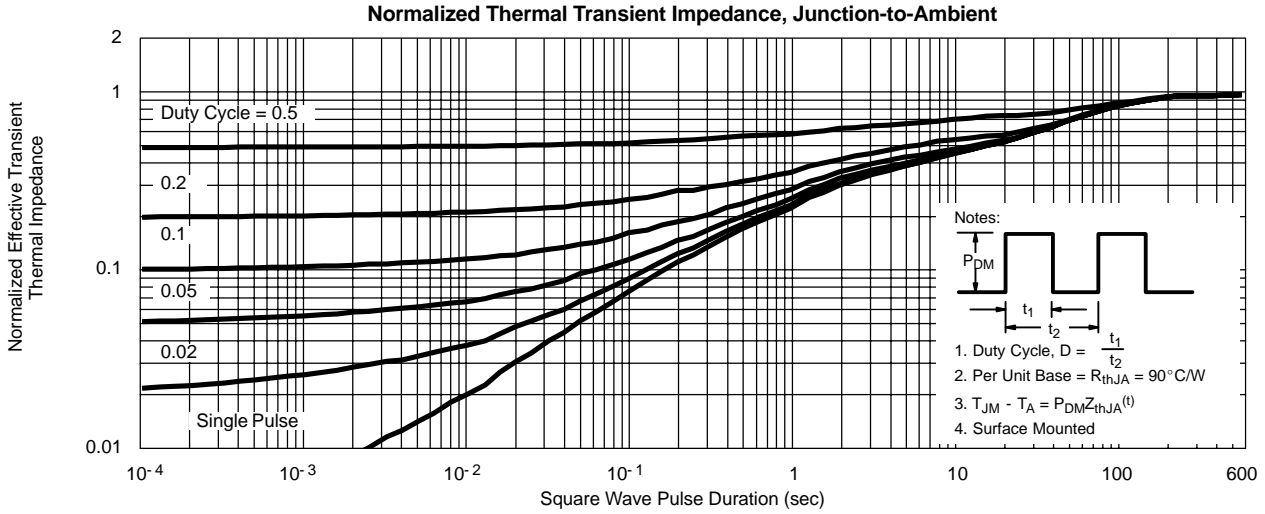

**TYPICAL CHARACTERISTICS (25°C UNLESS NOTED) SCHOTTKY**

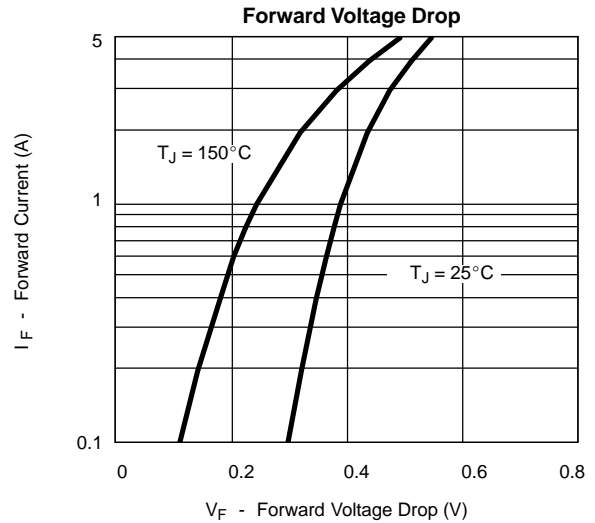
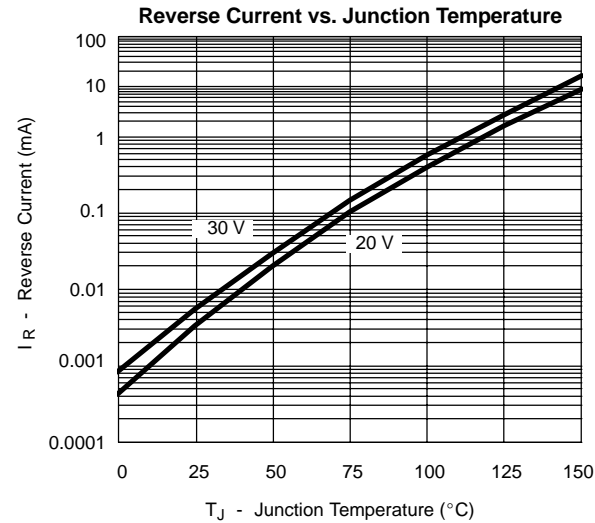

**TYPICAL CHARACTERISTICS (25 °C UNLESS NOTED)**

**SCHOTTKY**

