

## Switched Low Noise Amplifier 800 - 1000 MHz

AM55-0016  
V3

### Features

- High Gain State:
  - Gain: 16 dB, Noise Figure: 1.6 dB
  - Input IP<sub>3</sub>: +3 dBm (@2.7V, 25 mA)
- Low Gain State:
  - Insertion Loss: 5 dB, Input IP<sub>3</sub>: +24 dBm
- Single Supply: +2.7 to +5 VDC
- Low Cost MSOP-8 Plastic Package
- Adjustable current: 10 to 30 mA with external resistor

### Description

M/A-COM's AM55-0016 is a high dynamic range, switchable low noise amplifier in a low cost, MSOP 8-lead, surface mount, plastic package. The design utilizes a patented switching technique to provide a low insertion loss, high input IP<sub>3</sub> bypass state in parallel with the high gain, low noise state.

The LNA employs external input matching to obtain optimum noise figure performance and operating frequency flexibility. The AM55-0016 also features flexible biasing to control the current consumption vs. dynamic range trade-off. It's current can be controlled over a range of 10 mA to 30 mA with an external resistor.

Typical applications include receiver front ends in cellular band CDMA handsets. It is also useful as a switched gain block, buffer or driver in portable cellular systems.

The AM55-0016 is fabricated using a low-cost 0.5-micron gate length GaAs MESFET process. The process features full passivation for increased performance and reliability.

### Ordering Information <sup>1</sup>

Part Number	Package
AM55-0016	MSOP-8 Lead Plastic Package
AM55-0016TR	Forward Tape and Reel
AM55-0016SMB	Sample Test Board

1. Reference Application Note M513 for reel size information.

### Functional Block Diagram

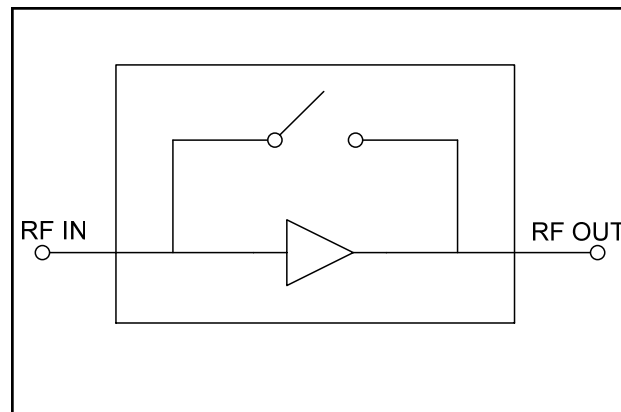

### Pin Configuration

Pin No.	Pin Name	Description
1	VDD1	Stage 1 Supply Voltage
2	IN	RF Input
3	VS1	Stage 1 Source
4	GND	RF and DC Ground
5	VS2	Stage 2 Source
6	OUT	RF Output
7	VDD2	Stage 2 Supply Voltage
8	VCTL	Switch Control Voltage

### Absolute Maximum Ratings <sup>2,3,4</sup>

Parameter	Absolute Maximum
V <sub>DD</sub>	+6 VDC
Input Power	0 dBm
Current	30 mA
Channel Temperature <sup>4</sup>	+150°C
Operating Temperature	-40°C to +85°C
Storage Temperature	-65°C to +150°C

2. Exceeding any one or combination of these limits may cause permanent damage to this device.
3. M/A-COM does not recommend sustained operation near these survivability limits.
4. Typical thermal resistance ( $\theta_{jc}$ ) = +99°C/W.

**Switched Low Noise Amplifier**  
800 - 1000 MHz

AM55-0016  
V3

**Electrical Specifications:**  $T_A = 25^\circ\text{C}$ ,  $Z_0 = 50 \Omega$ ,  $F = 881 \text{ MHz}$ ,  $P_{IN} = -30 \text{ dBm}$ ,  $V_{DD} = 2.7 \text{ V}$ ,  $I_{DD} = 10 \text{ mA}$

Parameter	Test Conditions	Units	Min.	Typ.	Max.
<b>HIGH GAIN STATE, Voltage control = 2.7 volts</b>					
Gain		dB	—	16	—
Noise Figure		dB	—	1.6	1.8
Input IP3	$I_{DD} = 10 \text{ mA}$ , $V_{DD} = 2.7 \text{ V}$ $I_{DD} = 25 \text{ mA}$ , $V_{DD} = 2.7 \text{ V}$	dBm	—	-2	—
		dBm	—	+3	—
Input VSWR / Output VSWR		—	—	2.0:1	—
Reverse Isolation		dB	—	32	—
<b>LOW GAIN STATE, Voltage control = 0 volts</b>					
Insertion Loss	$I_{DD} = 100 \mu\text{A}$	dB	—	5	—
Input IP3		dBm	—	+24	—
Input VSWR		—	—	2.3:1	—
Output VSWR		—	—	2.0:1	—

**Handling Procedures**

Please observe the following precautions to avoid damage.

**Static Sensitivity**

Gallium Arsenide Integrated Circuits are sensitive to electrostatic discharge (ESD) and can be damaged by static electricity. Proper ESD control techniques should be used when handling these devices.

**Evaluation PCB + RF Connector Losses**

Port Reference	Approximate RF Loss
RF IN	0.15 dB @ 900 MHz
RF OUT	0.15 dB @ 900 MHz

The DC connector on the Designer's Kit PCB allows convenient DC line access. This is accomplished by one or more of the following methods:

1. A mating female multi-pin connector (Newark Electronics Stock # 46F-4658, not included).
2. Wires soldered to the necessary pins (not included).
3. Clip leads (not included).

**Evaluation Board**

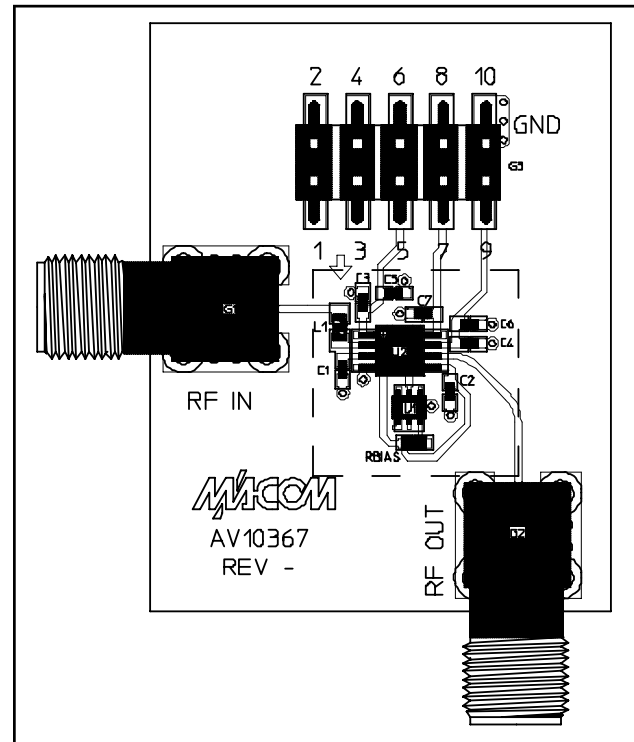

**Switched Low Noise Amplifier**  
800 - 1000 MHz

**AM55-0016**  
**V3**

**Recommended PCB Configuration**

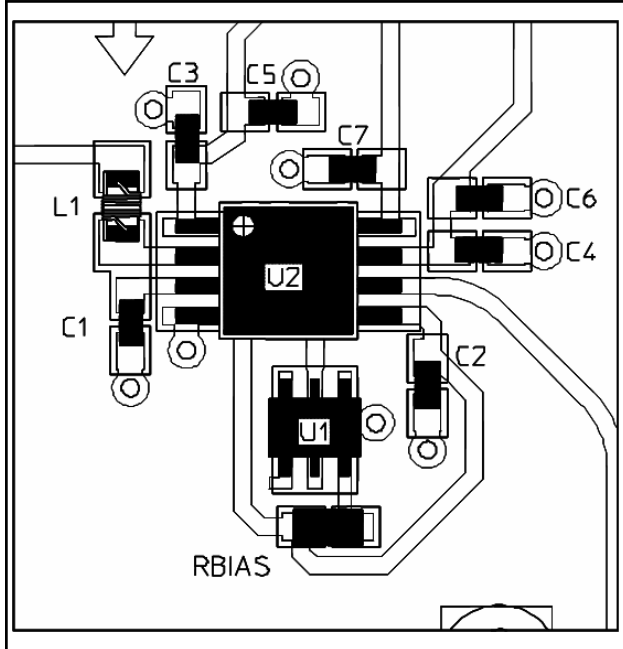

**Cross Section View**

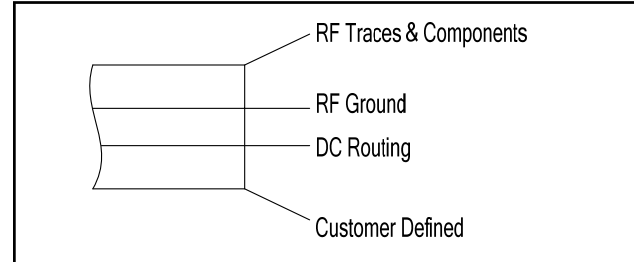

The PCB dielectric between RF traces and RF ground layers should be chosen to reduce RF discontinuities between 50  $\Omega$  lines and package pins. M/A-COM recommends an FR-4 dielectric thickness of 0.008" (0.2 mm) yielding a 50  $\Omega$  line width of 0.015" (0.38 mm). The recommended metallization thickness is 1 ounce copper.

**External Circuitry Parts List <sup>5</sup>**

Part	Value	Purpose
C1, C2	1000 pF	Source Bypass
C3, C4	47 pF	By-Pass
C5, C6, C7	10 nF	By-Pass
L1	22 nH	Tuning
RBIAS	See note 6	Source Bias Resistor
U1	UMH9N	Dual Bipolar Transistor

- All external circuitry parts are readily available, low cost surface mount components (0.040 inches x 0.020 inches or 0.060 inches x 0.030 inches).
- RBIAS is chosen to set the desired current,  
For:  $I_{DD} \sim 10$  mA,  $R1 = 75$  ohms;  
 $I_{DD} \sim 20$  mA,  $R1 = 25$  ohms;  
 $I_{DD} \sim 30$  mA,  $R1 = 9$  ohms.

**External Circuitry**

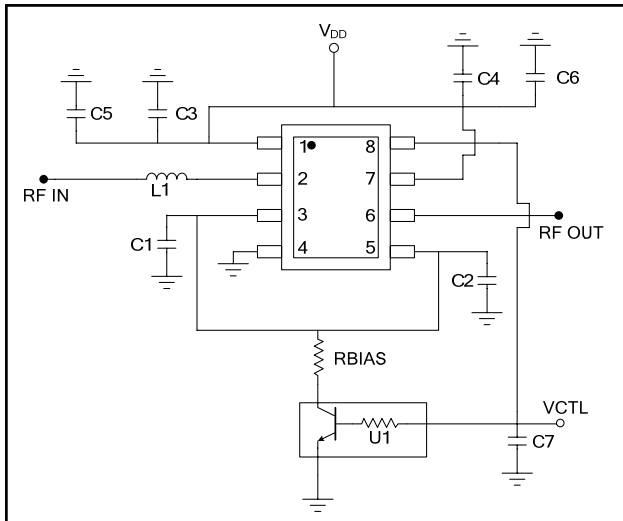

**Designer's Kit AM55-0016SMB**

The AM55-0016SMB Designer's Kit allows for immediate evaluation of M/A-COM's AM55-0016. The Designer's Kit includes an AM55-0016, an evaluation board and a floppy disk containing typical performance data and a DXF file of the recommended PCB layout. The evaluation board consists of the recommended external surface mount circuitry, RF connectors and a DC multi-pin connector, all mounted to a multi-layer FR-4 PCB. The AM55-0016SMB evaluation PCB is illustrated below with all functional ports labeled.

Switched Low Noise Amplifier  
800 - 1000 MHz

AM55-0016  
V3

Typical Performance Curves

High Gain Mode: Gain vs. Current

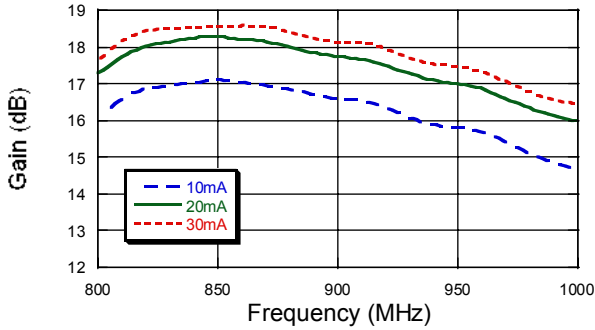

High Gain Mode: Noise Figure vs. Current

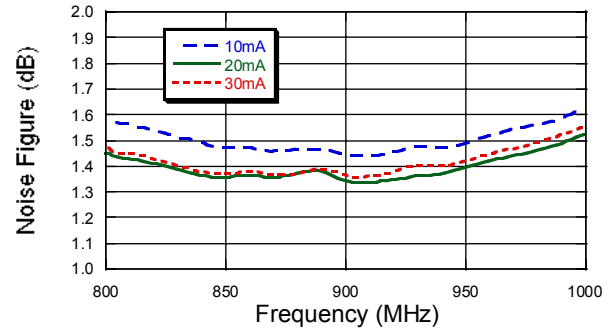

High Gain Mode: Input IP3 vs. Current

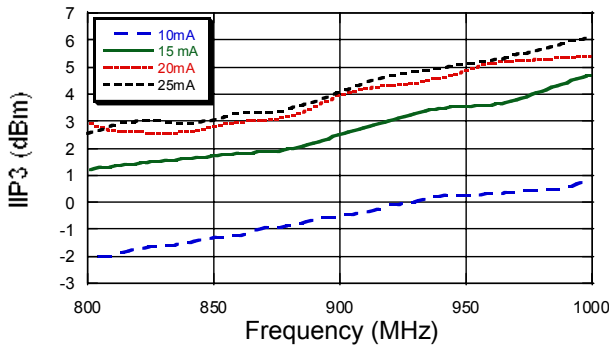

High Gain Mode: IIP3 vs. Current and Voltage

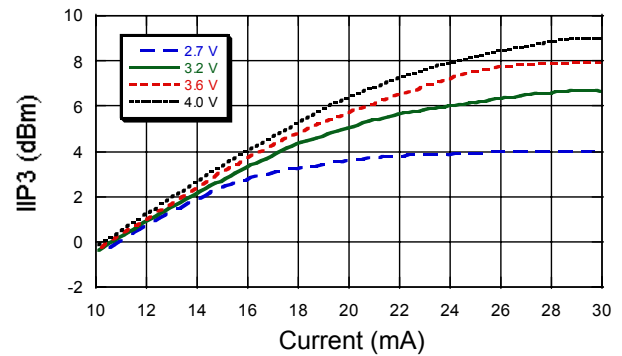

High Gain: Gain and Output Power vs. Input Power

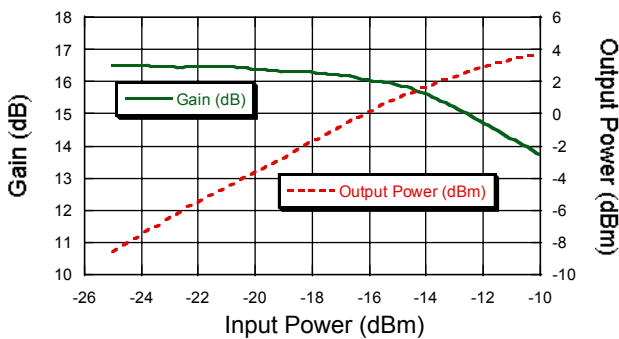

Low Gain Mode: Insertion Loss and Input IP3

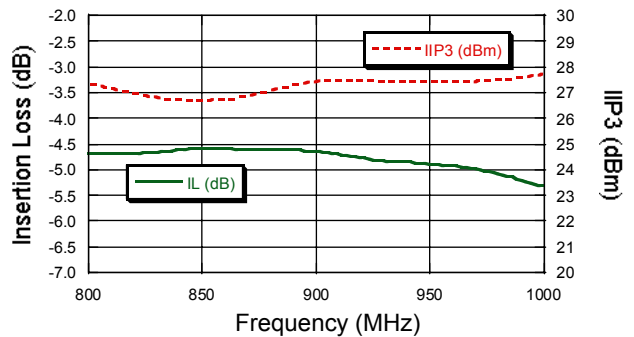

**Typical Performance Curves (continued)**

**Input Return Loss**

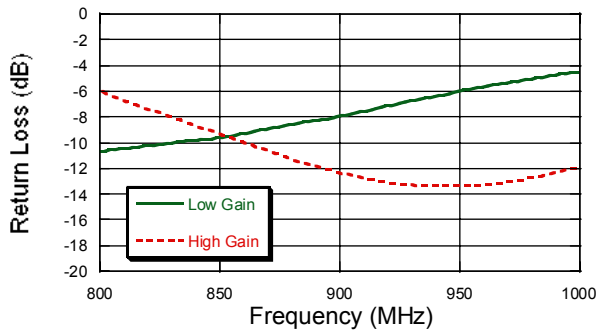

**Output Return Loss**

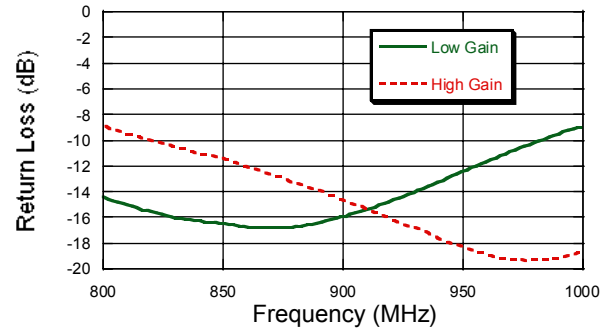

**High Gain Mode: Gain vs. Temperature**

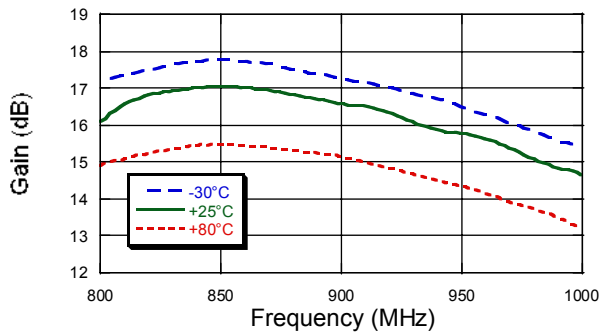

**High Gain Mode: Noise Figure vs. Temperature**

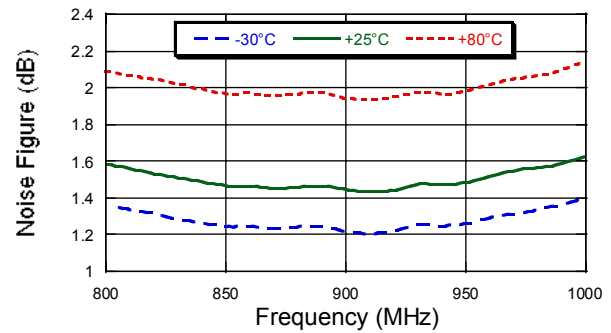

**Low Gain Mode: Insertion Loss vs. Temperature**

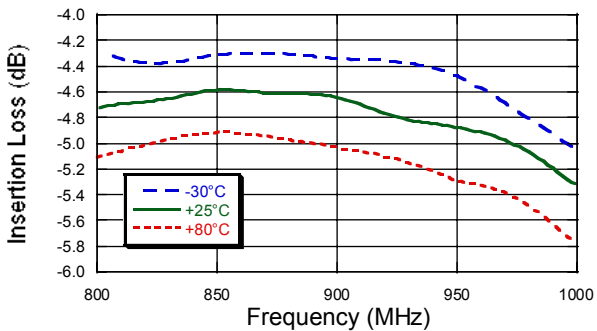

Switched Low Noise Amplifier  
800 - 1000 MHz

AM55-0016  
V3

MSOP-8<sup>†</sup>

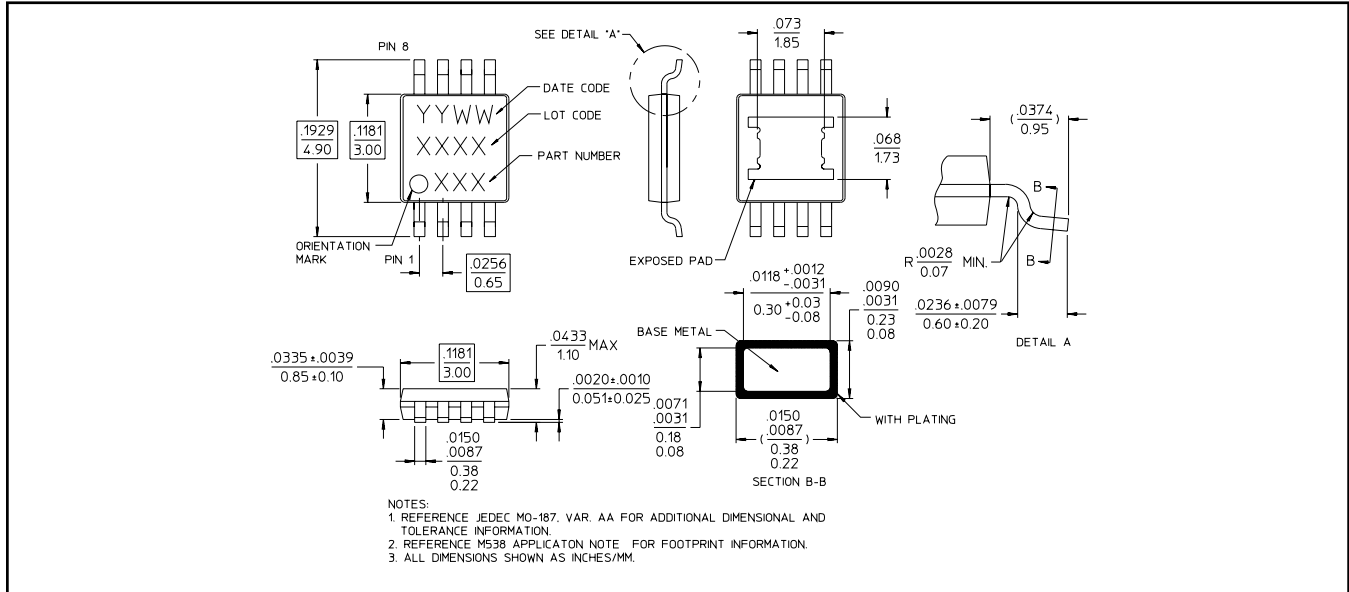

<sup>†</sup>Meets JEDEC moisture sensitivity level 1 requirements.