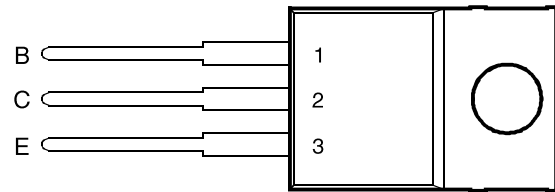

- 40 W at 25°C Case Temperature
- 2 A Continuous Collector Current
- 3 A Peak Collector Current
- Typical  $t_f = 200$  ns at 25°C

 TO-220 PACKAGE  
(TOP VIEW)

Pin 2 is in electrical contact with the mounting base.

absolute maximum ratings **at 25°C case temperature (unless otherwise noted)**

RATING	SYMBOL	VALUE	UNIT
Collector-base voltage ( $I_E = 0$ )	$V_{CBO}$	800	V
Collector-emitter voltage ( $V_{BE} = 0$ )	$V_{CES}$	800	V
Collector-emitter voltage ( $I_B = 0$ )	$V_{CEO}$	400	V
Continuous collector current	$I_C$	2	A
Peak collector current (see Note 1)	$I_{CM}$	3	A
Continuous device dissipation at (or below) 25°C case temperature	$P_{tot}$	40	W
Operating junction temperature range	$T_j$	-65 to +150	°C
Storage temperature range	$T_{stg}$	-65 to +150	°C

NOTE 1: This value applies for  $t_p \leq 2$  ms, duty cycle  $\leq 2\%$ .

# BUX84

## NPN SILICON POWER TRANSISTOR

### electrical characteristics at 25°C case temperature (unless otherwise noted)

PARAMETER	TEST CONDITIONS	MIN	TYP	MAX	UNIT
$V_{CEO(sus)}$ Collector-emitter sustaining voltage	$I_C = 0.1\text{ A}$ $L = 25\text{ mH}$ (see Note 2)	400			V
$I_{CES}$ Collector-emitter cut-off current	$V_{CE} = 800\text{ V}$ $V_{BE} = 0$ $V_{CE} = 800\text{ V}$ $V_{BE} = 0$ $T_C = 125^\circ\text{C}$			0.2 1	mA
$I_{EBO}$ Emitter cut-off current	$V_{EB} = 5\text{ V}$ $I_C = 0$			1	mA
$h_{FE}$ Forward current transfer ratio	$V_{CE} = 5\text{ V}$ $I_C = 0.1\text{ A}$ (see Notes 3 and 4)		35		
$V_{CE(sat)}$ Collector-emitter saturation voltage	$I_B = 0.03\text{ A}$ $I_C = 0.3\text{ A}$ $I_B = 0.2\text{ A}$ $I_C = 1\text{ A}$ (see Notes 3 and 4)			0.8 1	V
$V_{BE(sat)}$ Base-emitter saturation voltage	$I_B = 0.2\text{ A}$ $I_C = 1\text{ A}$ (see Notes 3 and 4)			1.1	V
$f_t$ Current gain bandwidth product	$V_{CE} = 10\text{ V}$ $I_C = 0.2\text{ A}$		12		MHz
$C_{ob}$ Output capacitance	$V_{CB} = 20\text{ V}$ $I_E = 0$ $f = 0.1\text{ MHz}$		60		pF

NOTES: 2. Inductive loop switching measurement.

3. These parameters must be measured using pulse techniques,  $t_p = 300\text{ }\mu\text{s}$ , duty cycle  $\leq 2\%$ .

4. These parameters must be measured using voltage-sensing contacts, separate from the current carrying contacts.

5. To obtain  $f_t$  the  $[h_{FE}]$  response is extrapolated at the rate of -6 dB per octave from  $f = 1\text{ MHz}$  to the frequency at which  $[h_{FE}] = 1$ .

### thermal characteristics

PARAMETER	MIN	TYP	MAX	UNIT
$R_{\theta JC}$ Junction to case thermal resistance			2.5	$^\circ\text{C/W}$

### resistive-load-switching characteristics at 25°C case temperature (unless otherwise noted)

PARAMETER	TEST CONDITIONS †	MIN	TYP	MAX	UNIT
$t_{on}$ Turn on time	$I_C = 1\text{ A}$ $I_{B(on)} = 0.2\text{ A}$ $I_{B(off)} = -0.4\text{ A}$ $V_{CC} = 250\text{ V}$ (see Figures 1 and 2)		0.25	0.5	$\mu\text{s}$
$t_s$ Storage time			1.8		$\mu\text{s}$
$t_f$ Fall time			0.2		$\mu\text{s}$
$t_f$ Fall time	$I_C = 1\text{ A}$ $I_{B(on)} = 0.2\text{ A}$ $I_{B(off)} = -0.4\text{ A}$ $V_{CC} = 250\text{ V}$ $T_C = 95^\circ\text{C}$			0.4	$\mu\text{s}$

† Voltage and current values shown are nominal; exact values vary slightly with transistor parameters.

PARAMETER MEASUREMENT INFORMATION

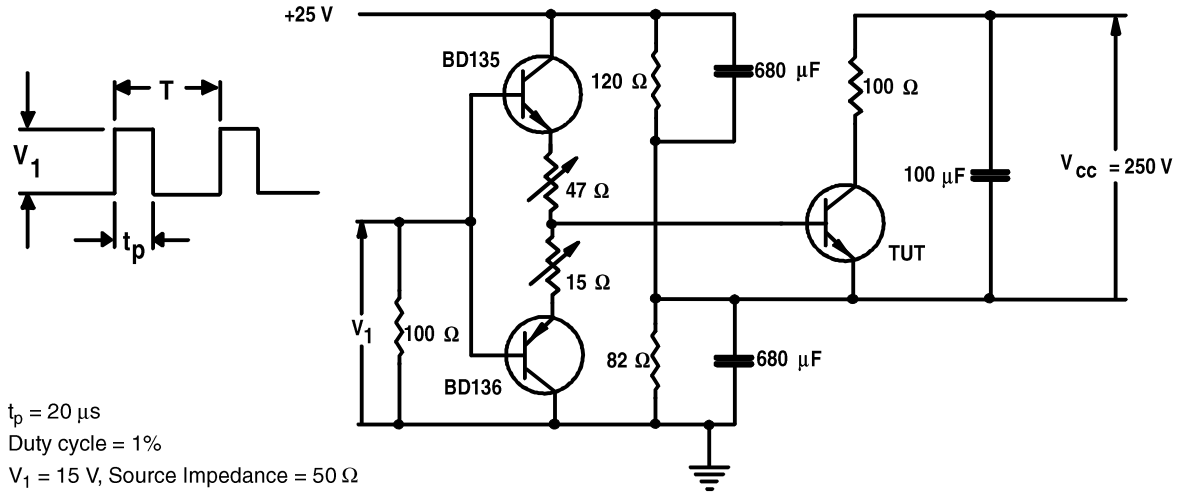

Figure 1. Resistive-Load Switching Test Circuit

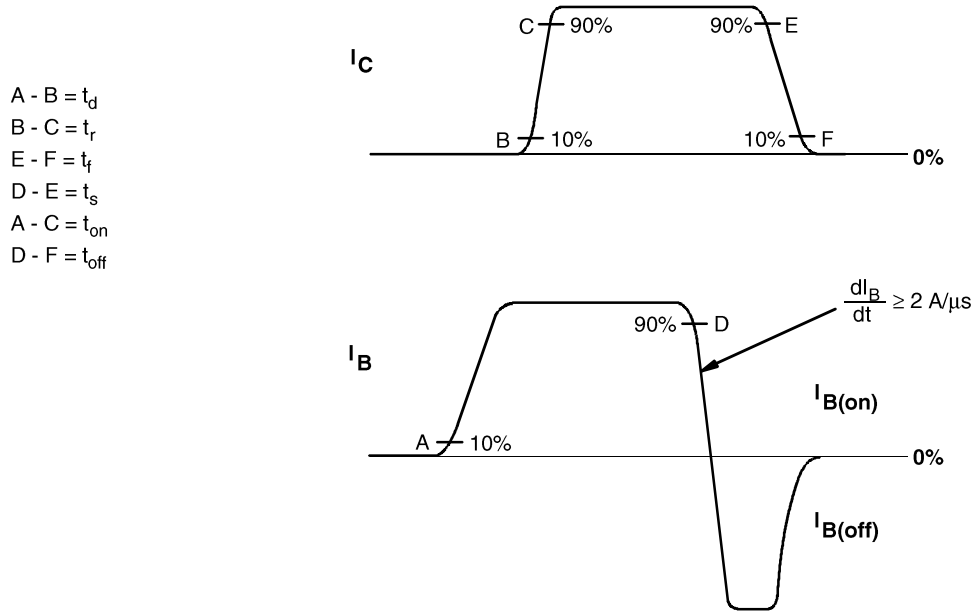

Figure 2. Resistive-Load Switching Waveform

**TYPICAL CHARACTERISTICS**

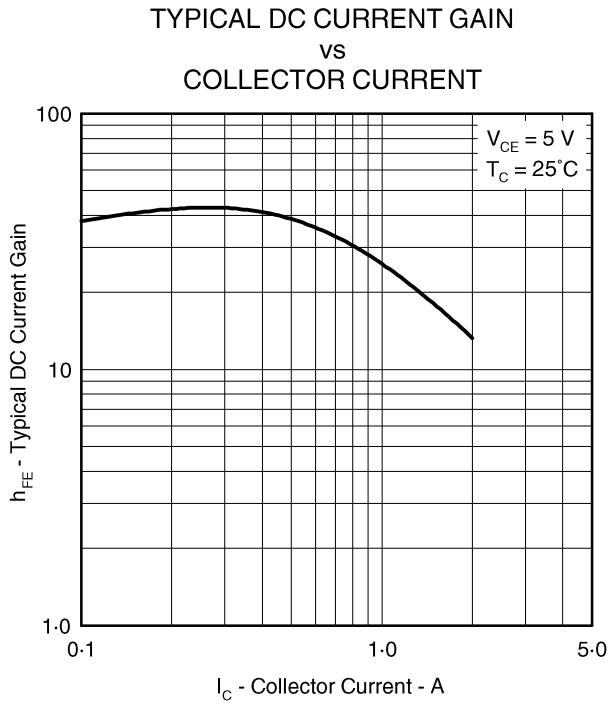

Figure 3.

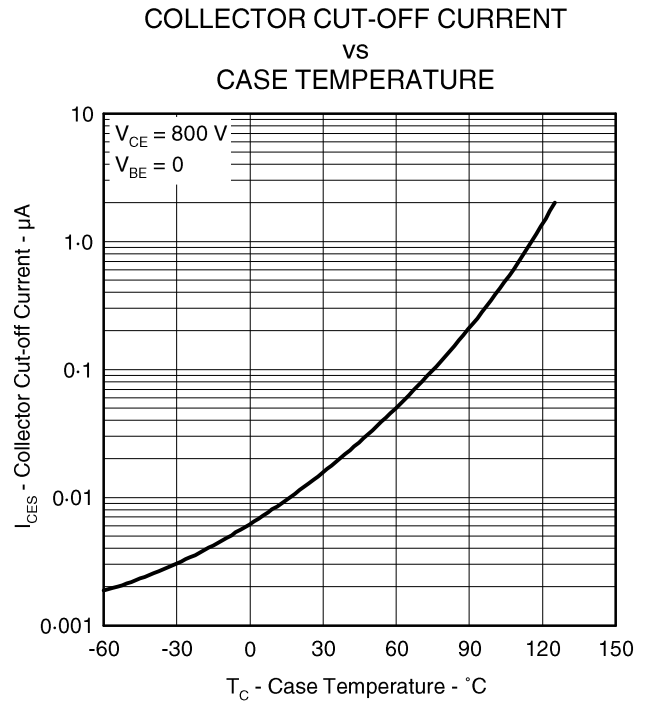

Figure 4.

**MAXIMUM SAFE OPERATING REGIONS**

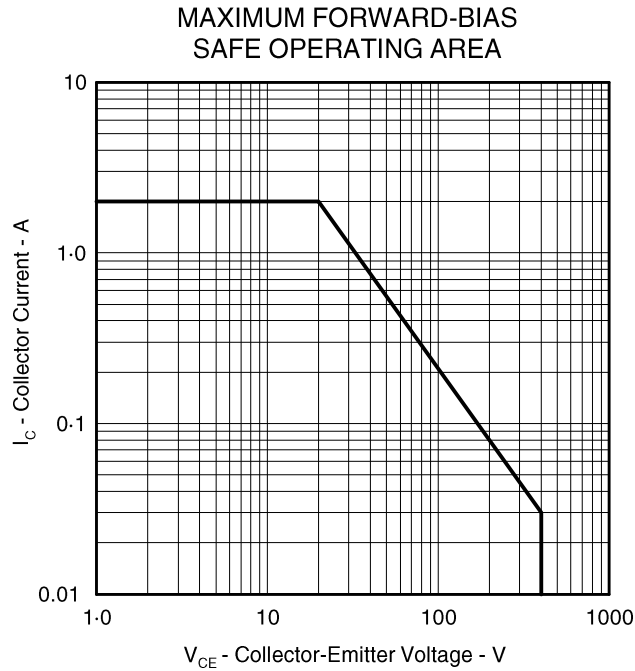

Figure 5.

THERMAL INFORMATION

THERMAL RESPONSE JUNCTION TO CASE  
vs  
POWER PULSE DURATION

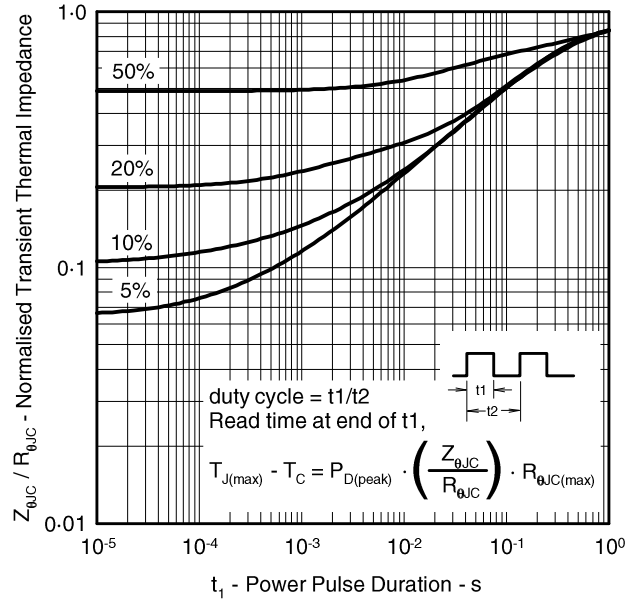

Figure 6.

# BUX84 NPN SILICON POWER TRANSISTOR

## MECHANICAL DATA

### TO-220

#### 3-pin plastic flange-mount package

This single-in-line package consists of a circuit mounted on a lead frame and encapsulated within a plastic compound. The compound will withstand soldering temperature with no deformation, and circuit performance characteristics will remain stable when operated in high humidity conditions. Leads require no additional cleaning or processing when used in soldered assembly.

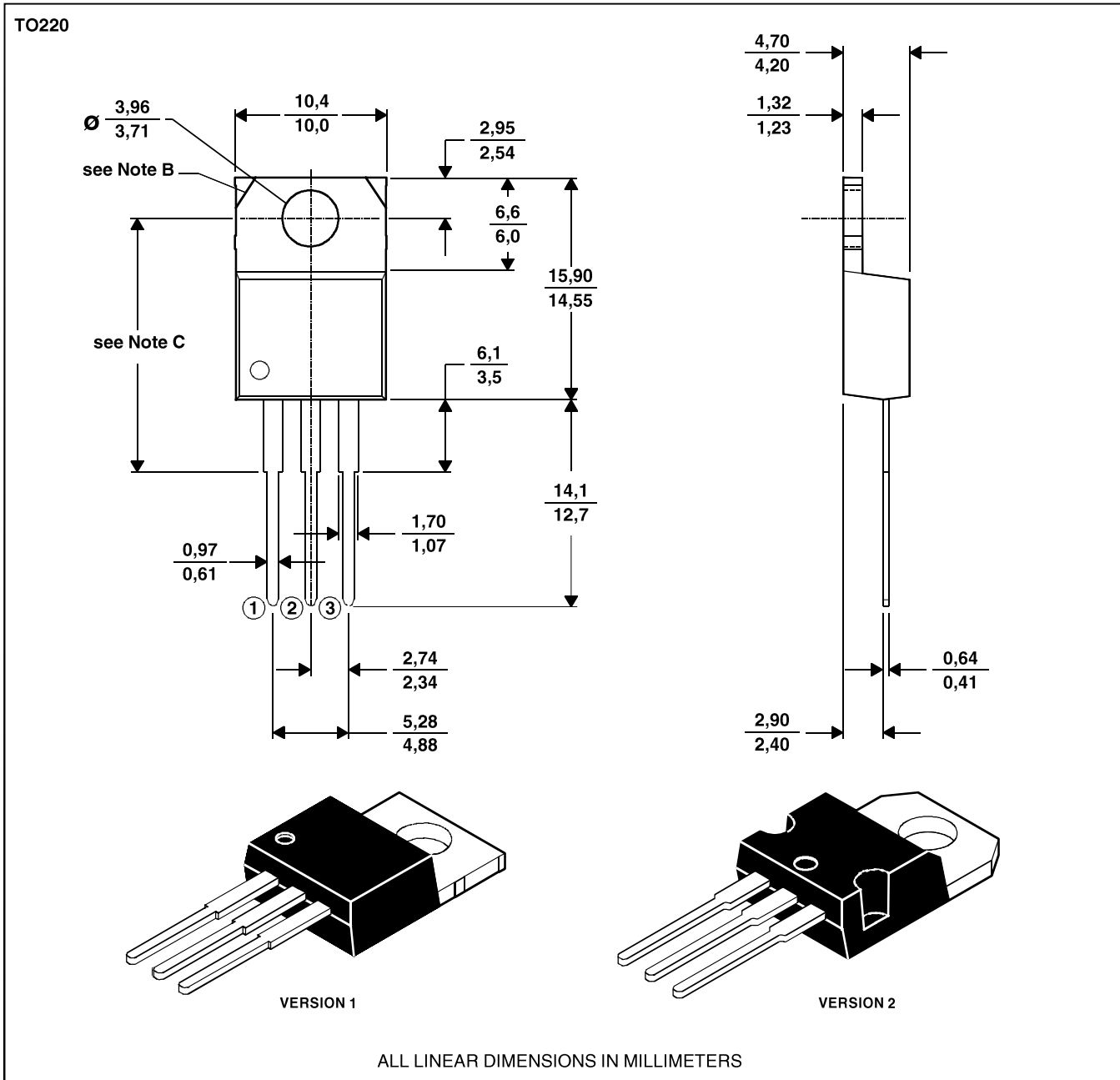

- NOTES: A. The centre pin is in electrical contact with the mounting tab.  
 B. Mounting tab corner profile according to package version.  
 C. Typical fixing hole centre stand off height according to package version.  
 Version 1, 18.0 mm. Version 2, 17.6 mm.