

Proximity Sensors Inductive Thermoplastic Polyester Housing Type EIA 4025, 40 x 40 x 120 mm

CARLO GAVAZZI



- Rotable-head, 5 positions
- Mounting dimensions in accordance with DIN 43694
- Glass-reinforced thermoplastic polyester housing
- Sensing distance: 25 mm
- LED-indication for power and output ON
- Fully protected
- DC types 4-wire NO & NC, 10-55 VDC
- AC/DC types 2-wire NO & NC, 20-250 VAC/DC

Product Description

Inductive proximity switch in standard limit switch housing. Rugged glass-reinforced polyester housing. Sensing face

adjustable in up to 5 positions. 2-wire AC/DC for maximum efficiency.

Ordering Key

EIA 4025 PPA P

Type _____
Housing type _____
Rated operating dist.(mm) _____
Output type _____
Housing material _____

Type Selection

Rated operating dist. (S _n)	Ordering no. Transistor NPN Make & break switching	Ordering no. Transistor PNP Make & break switching	Ordering no. Power MOSFET Make & break switching
25 mm ¹⁾	EIA 4025 NPAP	EIA 4025 PPAP	EIA 4025 UPAP ²⁾

¹⁾ For non-flush mounting

²⁾ Delivered: NO (make switching)

Specifications

	Transistor NPN/PNP	Power MOSFET output AC types
Rated operational voltage (U_e) (U_B)	11.3 to 50 VDC 10 to 55 VDC (rippled included)	24 to 230 VAC/VDC (VAC: 45 to 65 Hz) 20 to 250 VAC/VDC (VAC: 45 to 65 Hz)
Ripple	≤ 15%	-
Rated operational current (I_e) Continuous	≤ 200 mA	5 - 250 mA @ 25°C 5 - 180 mA @ 70°C
Short-time	-	≤ 2 A, t ≤ 20 ms (Max. 1 pulse per s)
No-load supply current (I_o)	≤ 25 mA	-
Minimum load current	-	5 mA
OFF-state current (I_r) (leakage)	50 μA	≤ 1.7 mA @ 120 VAC ≤ 2.5 mA @ 220 VAC
Voltage drop (U_d)	0.8 to 3.5 V	Static: ≤ 10.5 V Dynamic: ≤ 7.5 V
Protection	Reverse polarity, short-circuit	Transient voltages, short-circuit
Power ON delay	≤ 100 ms	≥ 200 ms
Frequency of operating cycles (f)	≤ 100 Hz	≤ 100 Hz
Indication for supply ON (LED 2)	LED, green	-
Indication for output ON (LED 1)	LED, yellow	LED, yellow
Rated operating dist. (S_n)	25 mm	25 mm
Repeat accuracy (R)	≤ 5%	≤ 5%

Specifications (cont.)

	Transistor NPN/PNP	Power MOSFET output AC types
Hysteresis (H) (Differential travel)	3 to 20% of sensing distance	3 to 20% of sensing distance
Effective operating dist. (S_r)	$0.9 \times S_n \leq S_r \leq 1.1 \times S_n$	$0.9 \times S_n \leq S_r \leq 1.1 \times S_n$
Usable operating dist. (S_u)	$0.9 \times S_r \leq S_u \leq 1.1 \times S_r$	$0.9 \times S_r \leq S_u \leq 1.1 \times S_r$
Ambient temperature Operating Storage	-25° to +70°C (-13° to +158°F) -30° to +80°C (-22° to +176°F)	-25° to +70°C (-13° to +158°F) -30° to +80°C (-22° to +176°F)
Degree of protection	IP 67 (Nema 1, 3, 4, 6, 13)	IP 67 (Nema 1, 3, 4, 6, 13)
Shock resistance	30 G/ 11 ms	30 G/ 11 ms
Vibration resistance	10 to 50 Hz/1 mm/5 min.	10 to 50 Hz/1 mm/5 min.
Housing material	PBTP	PBTP
Terminal block	4 terminals for 2 x 2.5 mm ² wires, self-lifting	2 terminals for 2 x 2.5 mm ² wires, self-lifting
Cable gland	M20 x 1.5	M20 x 1.5
Weight	200 g	200 g
CE-marking	Yes	Yes

Wiring Diagrams

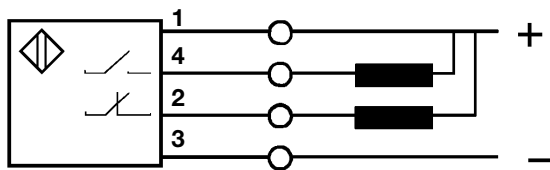

EIA 4025 NPAP

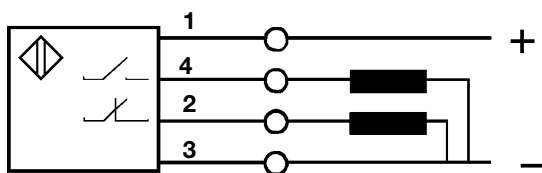

EIA 4025 PPAP

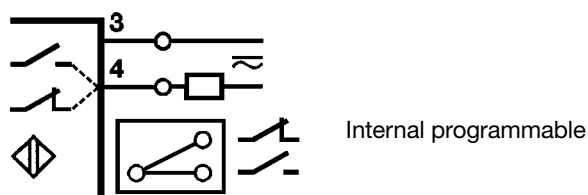

EIA 4025 UPAP

Dimensions

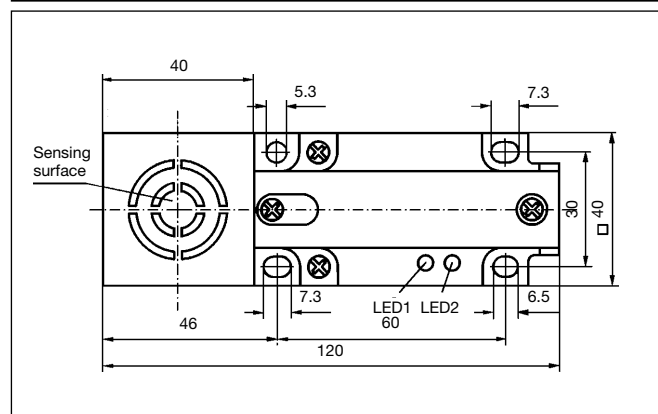

Installation Hints

Table 1

Installation examples

Sensing surface on head ("top"); other orientations of the sensing surface mean deviations from nominal sensing distance.

Figure 1

$a \text{ (mm)} \geq 40$
 $S_n \text{ (mm)} \leq 20$

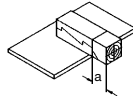

Figure 2

$a \text{ (mm)} \geq 40$
 $S_n \text{ (mm)} \leq 25$

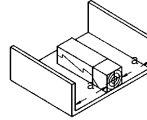

Figure 3

Flush mounting not permitted

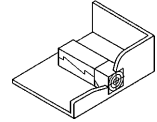

Table 2

Adjacent mounting

To avoid cross-interference when mounting the sensors next to each other, the given separations (a) should be maintained.

Figure 4

$a \text{ (mm)} \geq 120$

