

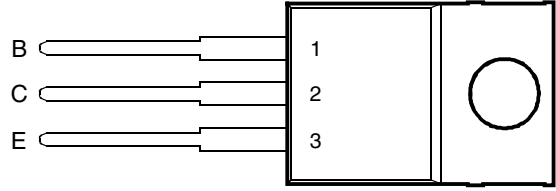

-
- 40 W at 25°C Case Temperature
- 2 A Continuous Collector Current
- 3 A Peak Collector Current
- Typical $t_f = 200$ ns at 25°C

TO-220 PACKAGE
(TOP VIEW)



Pin 2 is in electrical contact with the mounting base.

MDTRACA

absolute maximum ratings at 25°C case temperature (unless otherwise noted)

RATING	SYMBOL	VALUE	UNIT
Collector-base voltage ($I_E = 0$)	V_{CB0}	800	V
Collector-emitter voltage ($V_{BE} = 0$)	V_{CES}	800	V
Collector-emitter voltage ($I_B = 0$)	V_{CEO}	400	V
Continuous collector current	I_C	2	A
Peak collector current (see Note 1)	I_{CM}	3	A
Continuous device dissipation at (or below) 25°C case temperature	P_{tot}	40	W
Operating junction temperature range	T_j	-65 to +150	°C
Storage temperature range	T_{stg}	-65 to +150	°C

NOTE 1: This value applies for $t_p \leq 2$ ms, duty cycle $\leq 2\%$.

PRODUCT INFORMATION

AUGUST 1978 - REVISED SEPTEMBER 2002
Specifications are subject to change without notice.

electrical characteristics at 25°C case temperature (unless otherwise noted)

PARAMETER	TEST CONDITIONS	MIN	TYP	MAX	UNIT
$V_{CEO(sus)}$ Collector-emitter sustaining voltage	$I_C = 0.1\text{ A}$ $L = 25\text{ mH}$ (see Note 2)	400			V
I_{CES} Collector-emitter cut-off current	$V_{CE} = 800\text{ V}$ $V_{BE} = 0$ $V_{CE} = 800\text{ V}$ $V_{BE} = 0$ $T_C = 125^\circ\text{C}$			0.2 1	mA
I_{EBO} Emitter cut-off current	$V_{EB} = 5\text{ V}$ $I_C = 0$			1	mA
h_{FE} Forward current transfer ratio	$V_{CE} = 5\text{ V}$ $I_C = 0.1\text{ A}$ (see Notes 3 and 4)		35		
$V_{CE(sat)}$ Collector-emitter saturation voltage	$I_B = 0.03\text{ A}$ $I_C = 0.3\text{ A}$ $I_B = 0.2\text{ A}$ $I_C = 1\text{ A}$ (see Notes 3 and 4)			0.8 1	V
$V_{BE(sat)}$ Base-emitter saturation voltage	$I_B = 0.2\text{ A}$ $I_C = 1\text{ A}$ (see Notes 3 and 4)			1.1	V
f_t Current gain bandwidth product	$V_{CE} = 10\text{ V}$ $I_C = 0.2\text{ A}$		12		MHz
C_{ob} Output capacitance	$V_{CB} = 20\text{ V}$ $I_E = 0$ $f = 0.1\text{ MHz}$		60		pF

- NOTES: 2. Inductive loop switching measurement.
3. These parameters must be measured using pulse techniques, $t_p = 300\ \mu\text{s}$, duty cycle $\leq 2\%$.
4. These parameters must be measured using voltage-sensing contacts, separate from the current carrying contacts.
5. To obtain f_t the $[h_{FE}]$ response is extrapolated at the rate of -6 dB per octave from $f = 1\text{ MHz}$ to the frequency at which $[h_{FE}] = 1$.

thermal characteristics

PARAMETER	MIN	TYP	MAX	UNIT
$R_{\theta JC}$ Junction to case thermal resistance			2.5	°C/W

resistive-load-switching characteristics at 25°C case temperature (unless otherwise noted)

PARAMETER	TEST CONDITIONS †	MIN	TYP	MAX	UNIT
t_{on} Turn on time	$I_C = 1\text{ A}$ $I_{B(on)} = 0.2\text{ A}$ $I_{B(off)} = -0.4\text{ A}$ $V_{CC} = 250\text{ V}$ (see Figures 1 and 2)		0.25	0.5	μs
t_s Storage time			1.8		μs
t_f Fall time			0.2		μs
t_f Fall time	$I_C = 1\text{ A}$ $I_{B(on)} = 0.2\text{ A}$ $I_{B(off)} = -0.4\text{ A}$ $V_{CC} = 250\text{ V}$ $T_C = 95^\circ\text{C}$			0.4	μs

† Voltage and current values shown are nominal; exact values vary slightly with transistor parameters.

PARAMETER MEASUREMENT INFORMATION

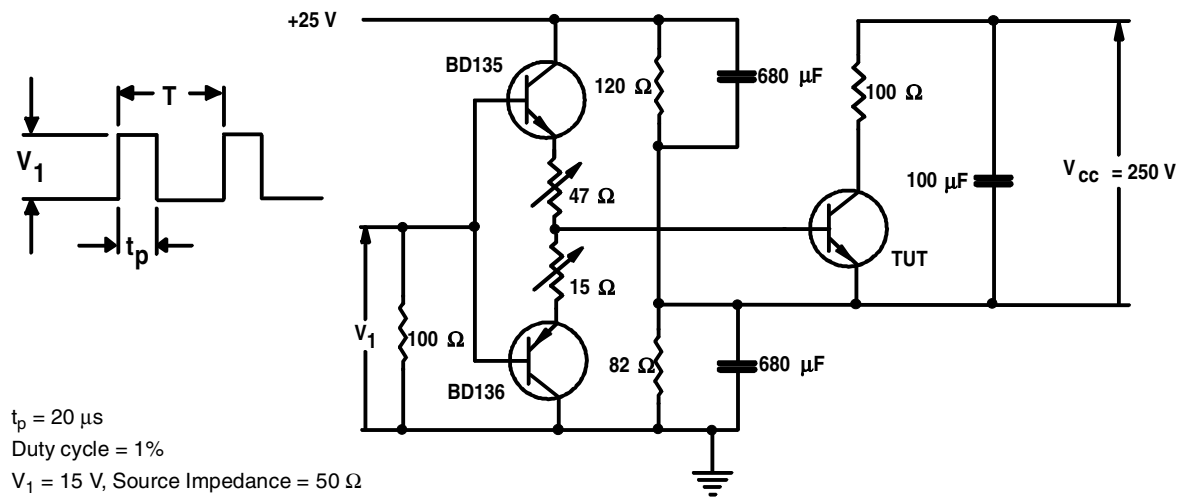

Figure 1. Resistive-Load Switching Test Circuit

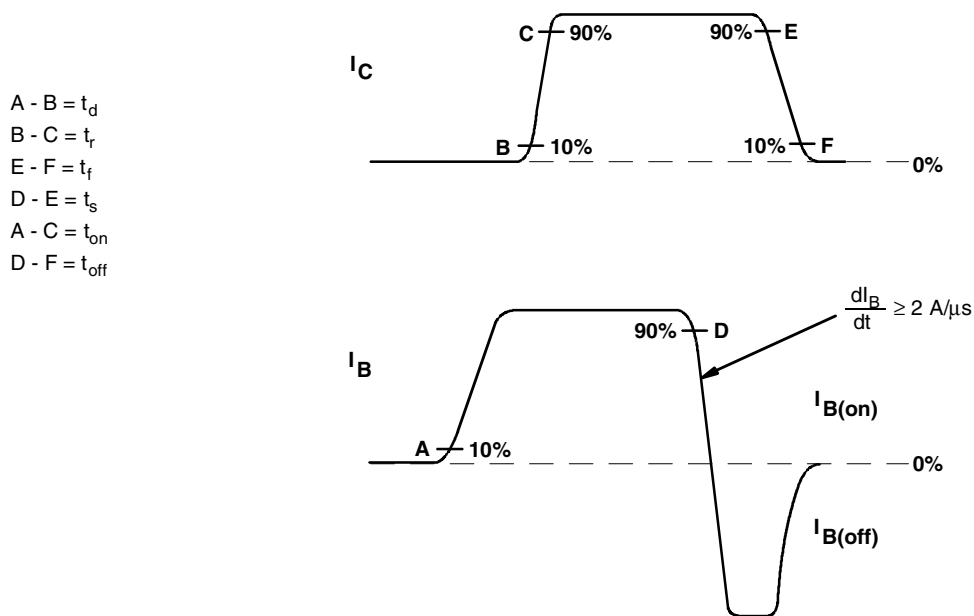

Figure 2. Resistive-Load Switching Waveforms

PRODUCT INFORMATION

AUGUST 1978 - REVISED SEPTEMBER 2002
 Specifications are subject to change without notice.

TYPICAL CHARACTERISTICS

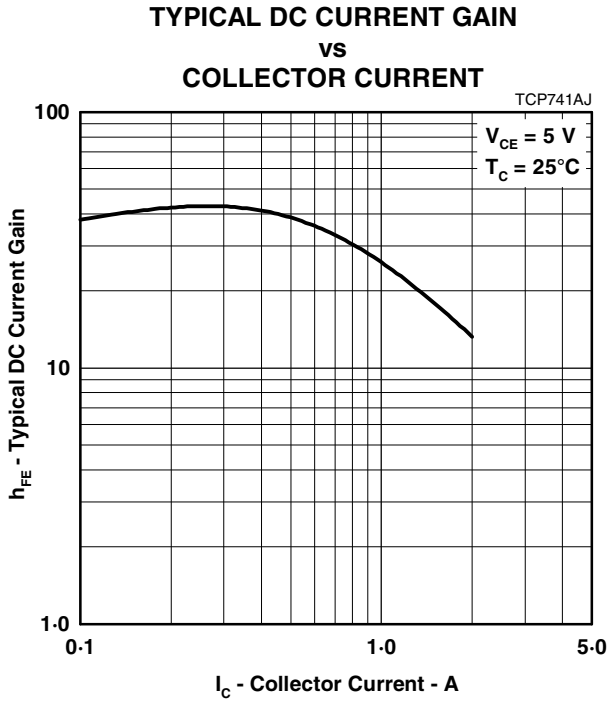

Figure 3.

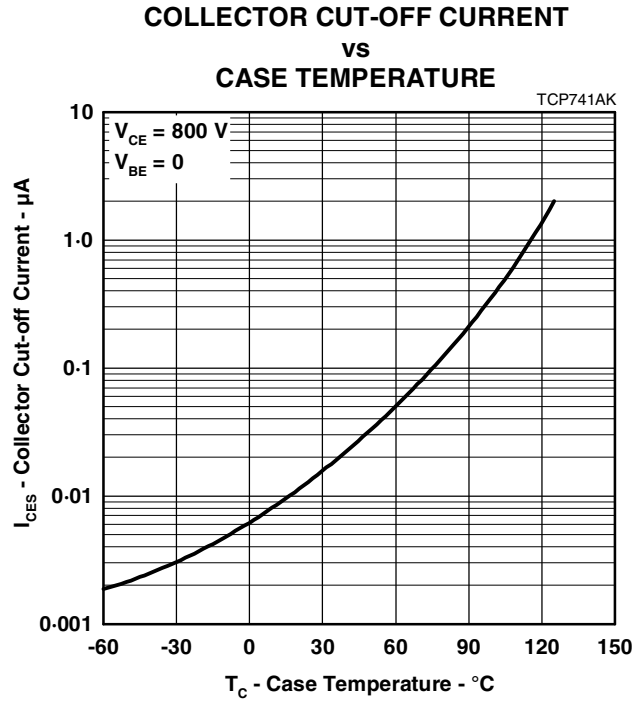

Figure 4.

MAXIMUM SAFE OPERATING REGIONS

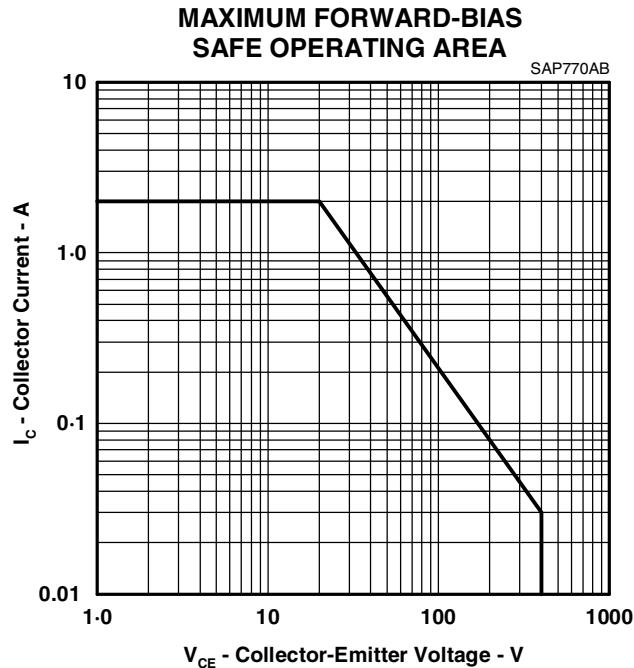

Figure 5.

PRODUCT INFORMATION

AUGUST 1978 - REVISED SEPTEMBER 2002
 Specifications are subject to change without notice.

THERMAL INFORMATION

**THERMAL RESPONSE JUNCTION TO CASE
VS
POWER PULSE DURATION**

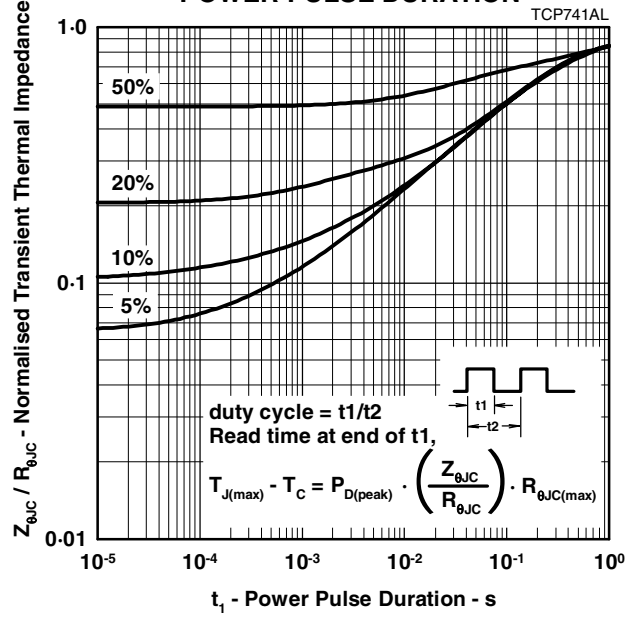

Figure 6.

PRODUCT INFORMATION

AUGUST 1978 - REVISED SEPTEMBER 2002
Specifications are subject to change without notice.

MECHANICAL DATA

TO-220

3-pin plastic flange-mount package

This single-in-line package consists of a circuit mounted on a lead frame and encapsulated within a plastic compound. The compound will withstand soldering temperature with no deformation, and circuit performance characteristics will remain stable when operated in high humidity conditions. Leads require no additional cleaning or processing when used in soldered assembly.

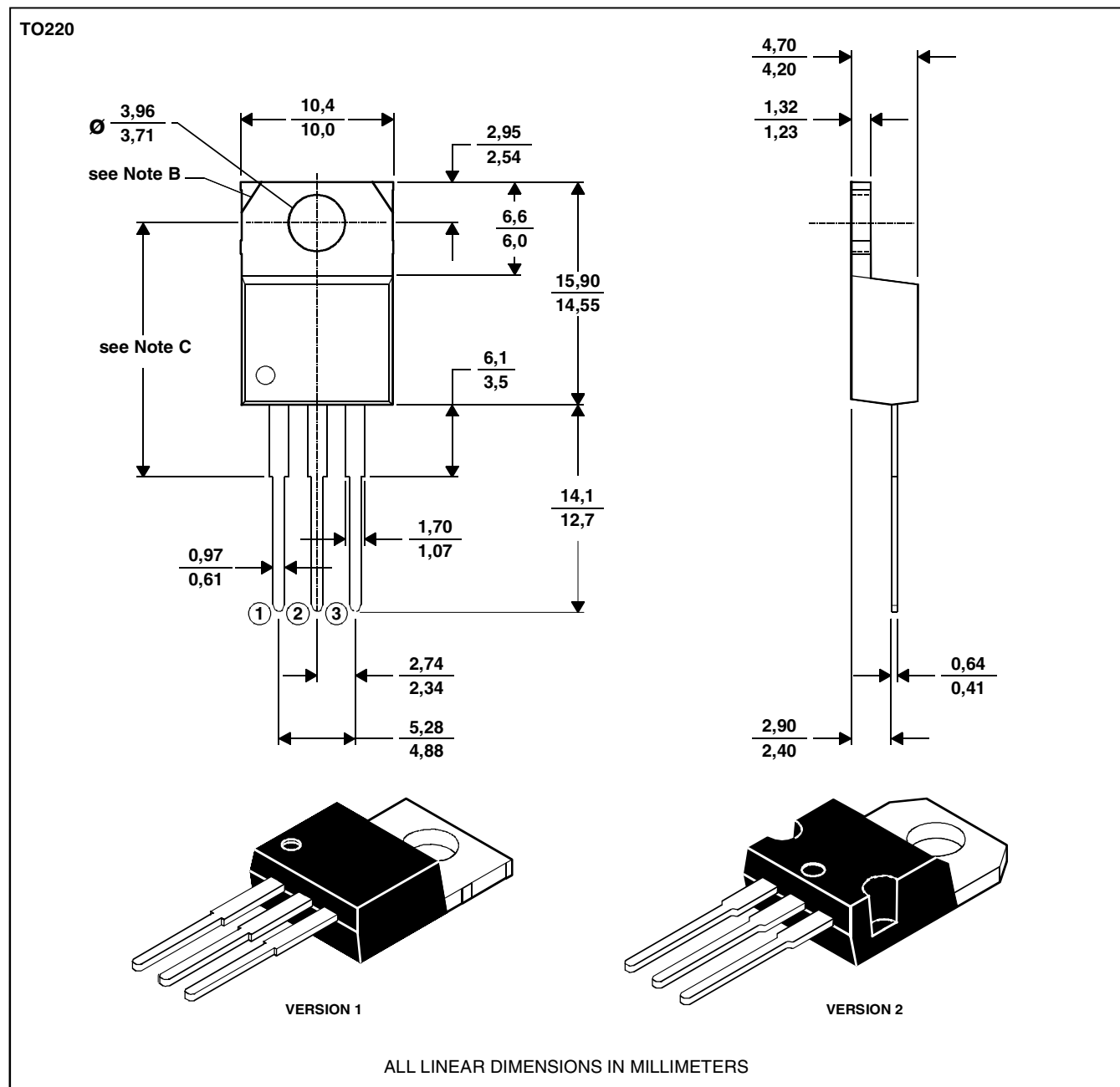

NOTES: A. The centre pin is in electrical contact with the mounting tab.
 B. Mounting tab corner profile according to package version.
 C. Typical fixing hole centre stand off height according to package version.
 Version 1, 18.0 mm. Version 2, 17.6 mm.

MDXXBE

PRODUCT INFORMATION

AUGUST 1978 - REVISED SEPTEMBER 2002
 Specifications are subject to change without notice.