

# FS70VSH-03

HIGH-SPEED SWITCHING USE

## FS70VSH-03



- 2.5V DRIVE
- $V_{DSS}$  ..... 30V
- $r_{DS(ON)}(MAX)$  ..... 14m $\Omega$
- $I_D$  ..... 70A
- Integrated Fast Recovery Diode (TYP.) ..... 70ns

## OUTLINE DRAWING

Dimensions in mm

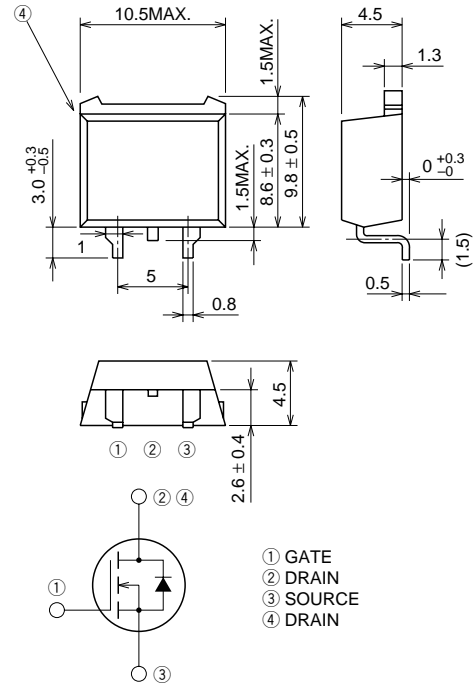

TO-220S

## APPLICATION

Motor control, Lamp control, Solenoid control  
DC-DC converter, etc.

## MAXIMUM RATINGS (Tc = 25°C)

Symbol	Parameter	Conditions	Ratings	Unit
$V_{DSS}$	Drain-source voltage	$V_{GS} = 0V$	30	V
$V_{GSS}$	Gate-source voltage	$V_{DS} = 0V$	$\pm 10$	V
$I_D$	Drain current		70	A
$I_{DM}$	Drain current (Pulsed)		280	A
$I_{DA}$	Avalanche drain current (Pulsed)	$L = 30\mu H$	70	A
$I_S$	Source current		70	A
$I_{SM}$	Source current (Pulsed)		280	A
$P_D$	Maximum power dissipation		70	W
$T_{ch}$	Channel temperature		-55 ~ +150	°C
$T_{stg}$	Storage temperature		-55 ~ +150	°C
—	Weight	Typical value	1.2	g

**ELECTRICAL CHARACTERISTICS** (T<sub>ch</sub> = 25°C)

Symbol	Parameter	Test conditions	Limits			Unit
			Min.	Typ.	Max.	
V (BR) DSS	Drain-source breakdown voltage	I <sub>D</sub> = 1mA, V <sub>GS</sub> = 0V	30	—	—	V
I <sub>GSS</sub>	Gate-source leakage current	V <sub>GS</sub> = ±10V, V <sub>DS</sub> = 0V	—	—	±0.1	μA
I <sub>DSS</sub>	Drain-source leakage current	V <sub>DS</sub> = 30V, V <sub>GS</sub> = 0V	—	—	0.1	mA
V <sub>GS</sub> (th)	Gate-source threshold voltage	I <sub>D</sub> = 1mA, V <sub>DS</sub> = 10V	0.6	0.9	1.2	V
r <sub>DS</sub> (ON)	Drain-source on-state resistance	I <sub>D</sub> = 35A, V <sub>GS</sub> = 4V	—	10	14	mΩ
r <sub>DS</sub> (ON)	Drain-source on-state resistance	I <sub>D</sub> = 35A, V <sub>GS</sub> = 2.5V	—	13	20	mΩ
V <sub>DS</sub> (ON)	Drain-source on-state voltage	I <sub>D</sub> = 35A, V <sub>GS</sub> = 4V	—	0.35	0.49	V
y <sub>fs</sub>	Forward transfer admittance	I <sub>D</sub> = 35A, V <sub>DS</sub> = 10V	—	60	—	S
C <sub>iss</sub>	Input capacitance	V <sub>DS</sub> = 10V, V <sub>GS</sub> = 0V, f = 1MHz	—	4000	—	pF
C <sub>oss</sub>	Output capacitance		—	800	—	pF
C <sub>rss</sub>	Reverse transfer capacitance		—	420	—	pF
t <sub>d</sub> (on)	Turn-on delay time	V <sub>DD</sub> = 15V, I <sub>D</sub> = 35A, V <sub>GS</sub> = 4V, R <sub>GEN</sub> = R <sub>GS</sub> = 50Ω	—	50	—	ns
t <sub>r</sub>	Rise time		—	250	—	ns
t <sub>d</sub> (off)	Turn-off delay time		—	350	—	ns
t <sub>f</sub>	Fall time		—	350	—	ns
V <sub>SD</sub>	Source-drain voltage	I <sub>S</sub> = 35A, V <sub>GS</sub> = 0V	—	1.0	1.5	V
R <sub>th</sub> (ch-c)	Thermal resistance	Channel to case	—	—	1.79	°C/W
t <sub>rr</sub>	Reverse recovery time	I <sub>S</sub> = 35A, di <sub>s</sub> /dt = -50A/μs	—	70	—	ns

**PERFORMANCE CURVES**

**POWER DISSIPATION DERATING CURVE**

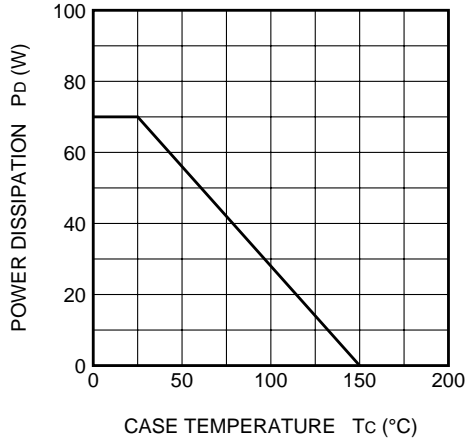

**MAXIMUM SAFE OPERATING AREA**

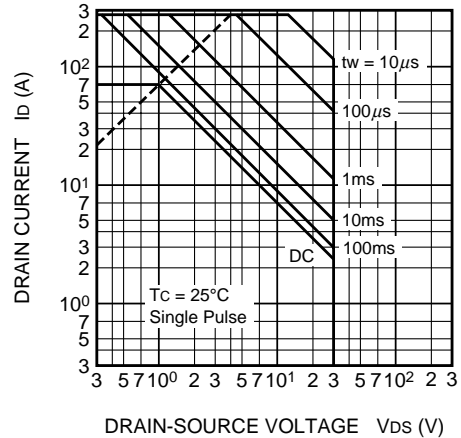

**OUTPUT CHARACTERISTICS (TYPICAL)**

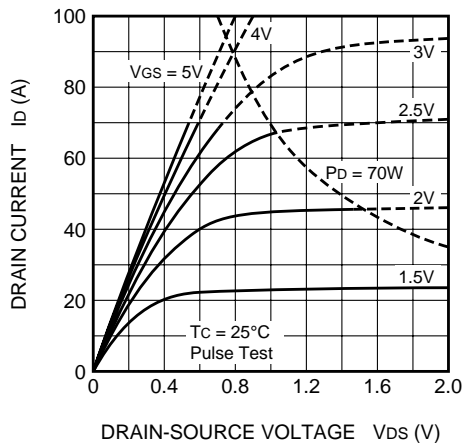

**OUTPUT CHARACTERISTICS (TYPICAL)**

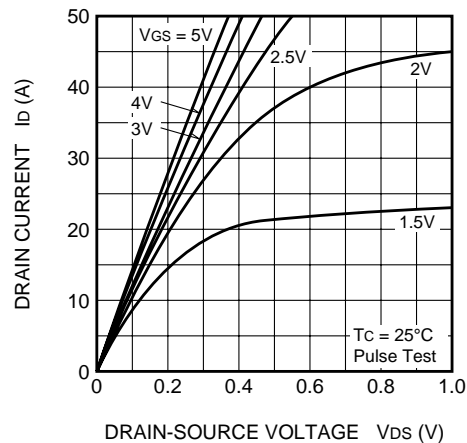

ON-STATE VOLTAGE VS. GATE-SOURCE VOLTAGE (TYPICAL)

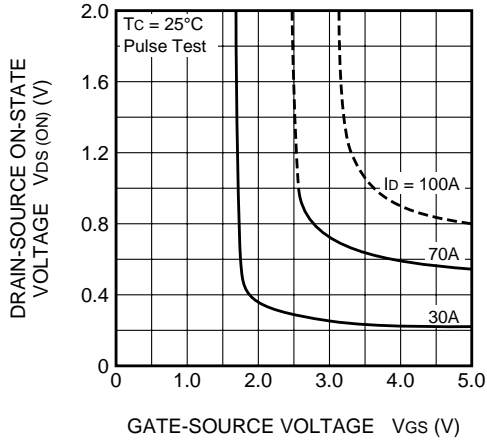

ON-STATE RESISTANCE VS. DRAIN CURRENT (TYPICAL)

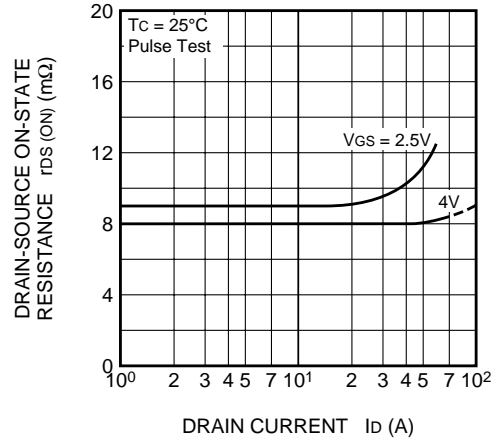

TRANSFER CHARACTERISTICS (TYPICAL)

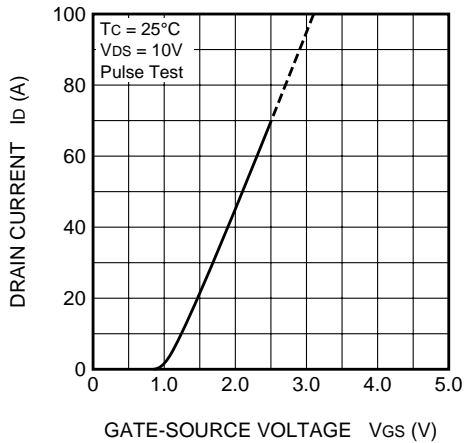

FORWARD TRANSFER ADMITTANCE VS. DRAIN CURRENT (TYPICAL)

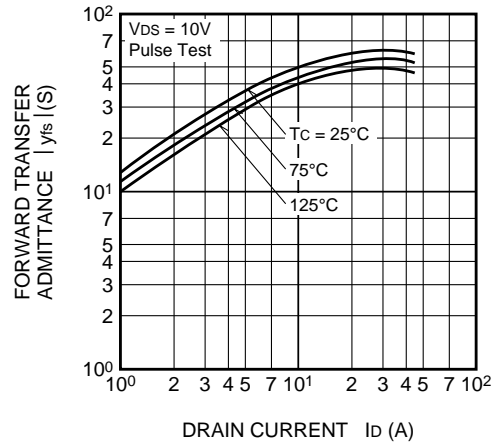

CAPACITANCE VS. DRAIN-SOURCE VOLTAGE (TYPICAL)

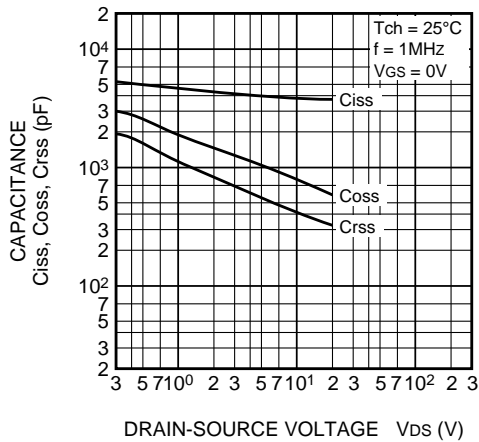

SWITCHING CHARACTERISTICS (TYPICAL)

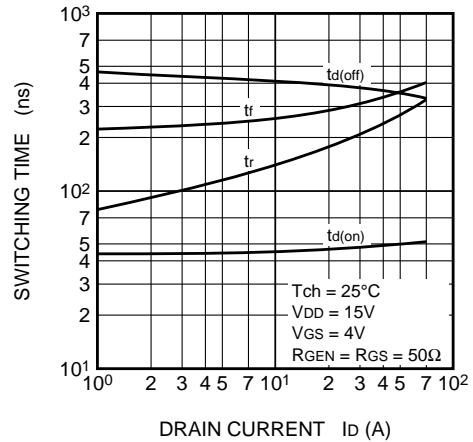

GATE-SOURCE VOLTAGE VS. GATE CHARGE (TYPICAL)

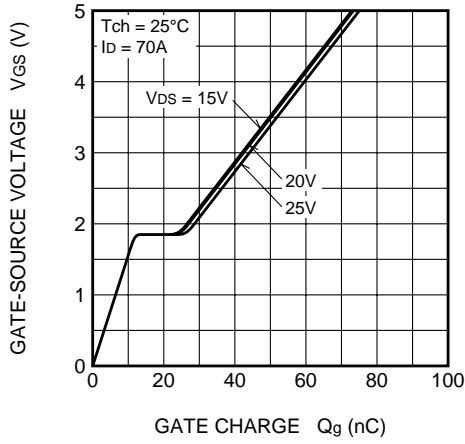

SOURCE-DRAIN DIODE FORWARD CHARACTERISTICS (TYPICAL)

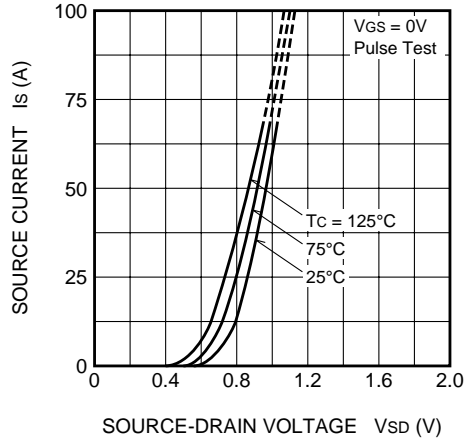

ON-STATE RESISTANCE VS. CHANNEL TEMPERATURE (TYPICAL)

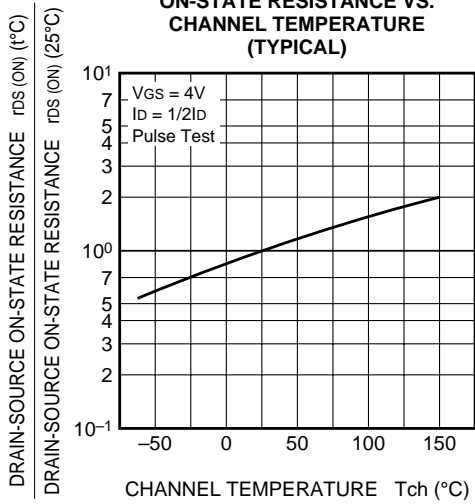

THRESHOLD VOLTAGE VS. CHANNEL TEMPERATURE (TYPICAL)

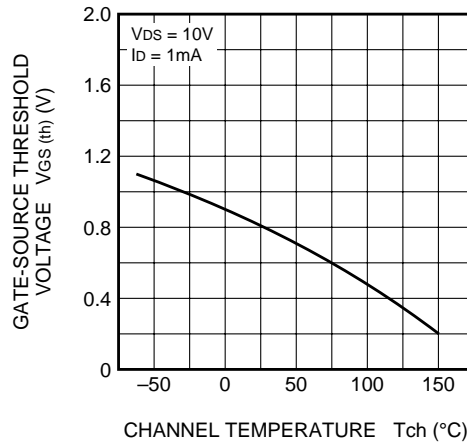

BREAKDOWN VOLTAGE VS. CHANNEL TEMPERATURE (TYPICAL)

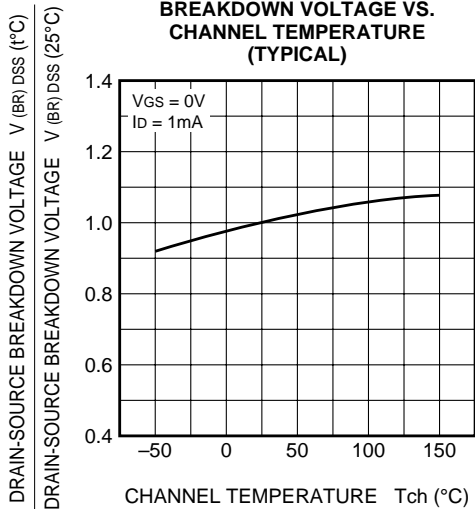

TRANSIENT THERMAL IMPEDANCE CHARACTERISTICS

