



AKD4569

Evaluation board Rev.A for AK4569

GENERAL DESCRIPTION

The AKD4569 is an evaluation board for the AK4569, the Audio CODEC with IPGA and HP-amp. The AKD4569 can evaluate A/D and D/A in addition to A/D to D/A loopback mode. The AKD4569 also has the digital audio interface and can achieve the interface with digital audio systems via opt-connector.

■ **Ordering guide**

AKD4569 --- Evaluation board for AK4569
 (Cable for connecting with printer port of IBM-AT compatible PC and control software are packed with this. This control software does not support Windows NT.)

FUNCTION

- **Compatible with 2 types of interface**
 - DIR(AK4116)/DIT(AK4114) with optical input/output
 - Direct interface with AKM's A/D,D/A converter evaluation boards by 10pin header
- **10pin header for serial control interface**

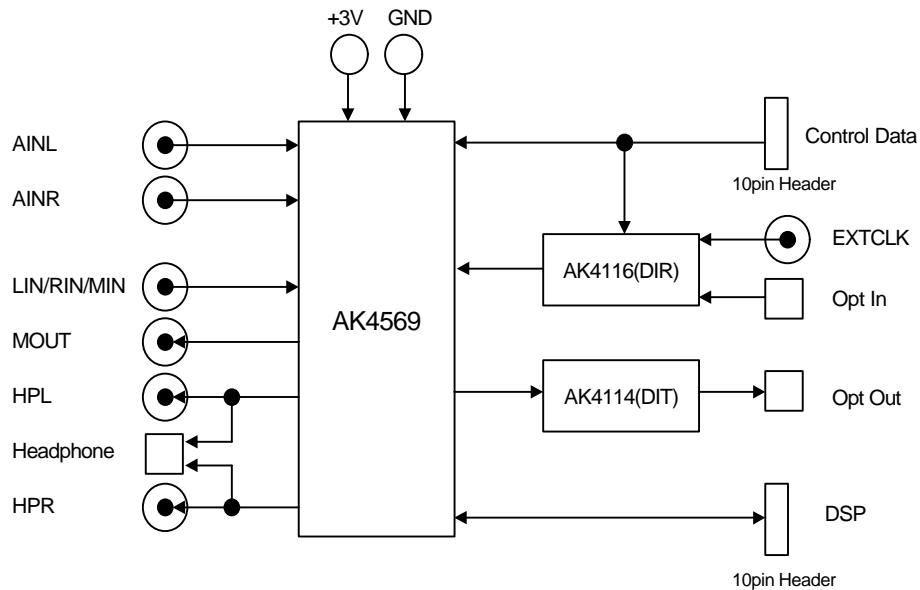

Figure 1. AKD4569 Block Diagram

* Circuit diagram and PCB layout are attached at the end of this manual.

■ Operation sequence

1) Set up the power supply lines.

Name	Color	Voltage	Contents	Attention
+5V	Red	5V	Regulator	JP15 should be shorted and HVDD jack should be open when the regulator is used. (Default: JP15 is open.)
HVDD	Orange	3V	AK4569 Headphone amp	JP15 should be open when the regulator is NOT used.
AVDD	Orange	3V	AK4569 Analog	JP4 should be shorted and AVDD jack should be open when AVDD is supplied from HVDD. (Default: JP4 is shorted.)
DVDD	Orange	3V	AK4569 Digital	JP14 should be shorted and DVDD jack should be open when DVDD is supplied from HVDD. (Default: JP14 is shorted.)
VD	Orange	3V	Logic Parts	JP13 should be shorted and VD jack should be open when VD is common with DVDD. (Default: JP13 is shorted.)
AGND	Black	0V	Analog ground	AGND jack should be always supplied.
DGND	Black	0V	Digital ground	DGND jack can be open if JP1 is shorted. (Default: JP1 is shorted.)

Table 1. Set up of power supply lines

Each supply line should be distributed from the power supply unit.

2) Set-up the evaluation modes, jumper pins and DIP switches. (See the followings.)

3) Power on.

The AK4569 should be reset once bringing SW1(4569_PDN) “L” upon power-up.

4) Serial control

The AK4569 can be controlled via the printer port (parallel port) of IBM-AT compatible PC. Connect PORT1(uP-I/F) with PC by 10-line flat cable packed with the AKD4569.

Take care of the direction of connector. There is a mark at pin#1.
The pin layout of PORT1 is as Figure 2.

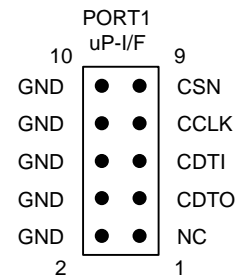

Figure 2. Pin Layout of PORT1

■ Evaluation mode

Applicable evaluation modes

- (1) Loopback mode
- (2) Evaluation of A/D part
- (3) Evaluation of D/A part (Default)
- (4) All interface signals including master clock are fed externally.

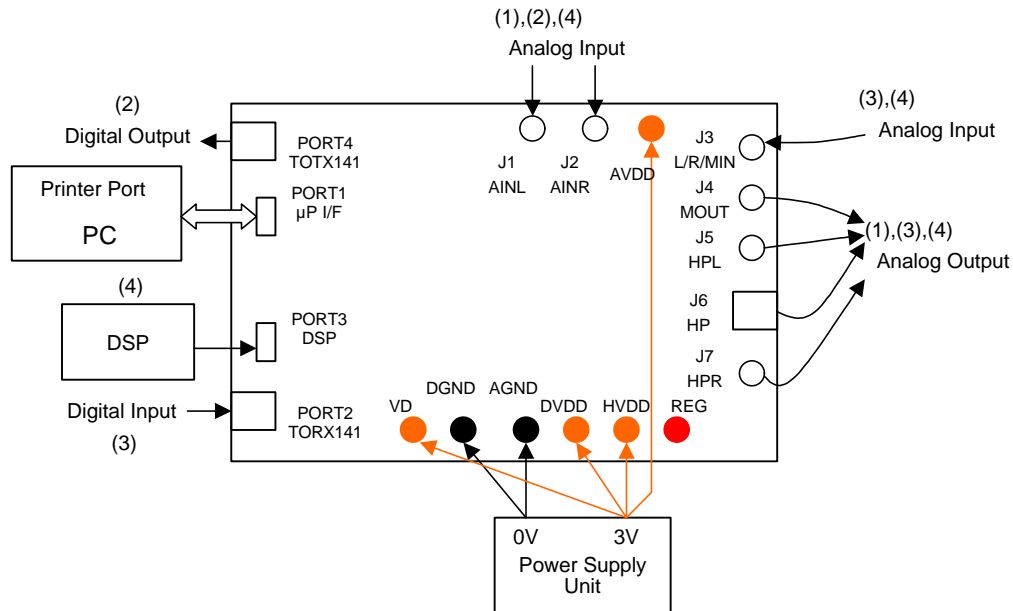

Figure 3. Connection diagram for each evaluation mode

<Setup of jumper pins, signal I/O connector and DIR for each evaluation mode>

	Mode (1)	Mode (2)	Mode (3)	Mode (4)
JP6 (MCLK)	short	short	short	open
JP7 (SDTI)	ADC side	Don't care	DIR side	open
JP8 (BICK)	short	short	short	open
JP9 (LRCK)	short	short	short	open
Signal input	J1(AINL), J2(AINR)	J1(AINL), J2(AINR)	PORT2(TORX141), J3(LIN/RIN/MIN)	PORT3(DSP)
Signal output	J4(MOUT), J5(HPL), J7(HPR), J6(HP)	PORT4(TOTX141)	J4(MOUT), J5(HPL), J7(HPR), J6(HP)	J4(MOUT), J5(HPL), J7(HPR), J6(HP)
AK4116(DIR) Clock mode (CM1-0 bit)	X'tal mode (CM1-0 = "01")	X'tal mode (CM1-0 = "01")	PLL mode (CM1-0 = "00")	X'tal mode (CM1-0 = "01")

Table 2. Setup of jumper pins etc. for each evaluation mode

<Details for each evaluation mode>

(1) Loopback mode

MCLK, BICK and LRCK are fed from on-board DIR (AK4116). The clock source can be selected from on-board X'tal oscillator or external master clock through a BNC connector (J8: EXTCLK).

CM1-0 bit (Addr=01H) of AK4116 should be set to "01" by the control software "akd4116-1.exe" packed with AKD4569.

(2) Evaluation of ADC

AK4114 (DIT) generates audio bi-phase signal from received data and which is output through optical connector (PORT4: TOTX141). It is possible to connect AKM's D/A converter evaluation boards or the digital-amplifier which equips DIR input. SW3 is used to set the interface format and clock mode of AK4114 (see DIP-SW set-up).

CM1-0 bit (Addr=01H) of AK4116 should be set to "01" by the control software "akd4116-1.exe" packed with AKD4569.

(3) Evaluation of DAC (Default)

On-board DIR (AK4116) generates MCLK, BICK, LRCK and SDATA from the received data through optical connector (TORX141). Used for the evaluation using CD test disk. Nothing should be connected to PORT3(DSP).

(4) Feeding all signals externally

AK4569 can be evaluated by connecting DSP to PORT3(DSP).

■ Other jumper pins setup

[JP2] (AINL): ADC Lch input select (Default: AINL1)

[JP3] (AINR): ADC Rch input select (Default: AINR1)

[JP5] (LIN/RIN/MIN): External analog input select (Default: MIN)

[JP10] (HPL): Headphone Lch output
 Short: Output from J5(BNC) (Default)
 Open: Output from J6(Headphone jack)

[JP11] (HPR): Headphone Rch output
 Short: Output from J7(BNC) (Default)
 Open: Output from J6(Headphone jack)

[JP12] (EXTCLK): Clock source
 Short: External clock is input via J8(EXTCLK). On-chip X'tal (X1) should be removed.
 Open: On-chip X'tal (X1) is used. (Default)

■ DIP-SW set-up (setup for AK4114)

No.	Name	Default	Contents
1	DIF0	OFF	AK4114 interface format (See Table 4.)
2	OCKS1	OFF	AK4114 clock mode (See Table 5.)
3	NC	OFF	Don't care
4			
5			

Table 3. SW3 setup (1=ON, 0=OFF)

Format	No.1 (DIF0)	Default
24bit, Left justified	0	
I ² S	1	

Table 4. AK4114 interface format setup (1=ON, 0=OFF)

Clock mode	No.2 (OCKS1)	Default
256fs	0	
512fs	1	

Table 5. AK4114 clock mode setup (1=ON, 0=OFF)

■ The function of the toggle SW

[SW1](4569_PDN): Resets the AK4569. Keep "H" during normal operation.

[SW2](4116_PDN): Resets the AK4116(DIR). Keep "H" during normal operation.

[SW3](4114_PDN): Resets the AK4114(DIT). Keep "H" during normal operation.

■ The indication content for LED

LED turns on when each output goes "H".

[LE1] (INT1): INT1 of AK4116(DIR)

[LE2] (INT0): INT0 of AK4116(DIR)

AK4569 Control Program operation manual

■ Set-up of evaluation board and control software

1. Set up the AKD4569 according to above mentioned setting.
2. Connect IBM-AT compatible PC with AKD4569 by 10-line type flat cable (packed with AKD4569). Take care of the direction of 10pin header. (Please install the driver in the floppy-disk when this control software is used on Windows 2000/XP. Please refer "Installation Manual of Control Software Driver by AKM device control software". In case of Windows95/98/ME, this installation is not needed. This control software does not operate on Windows NT.)
3. Insert the CD-ROM labeled "AK4569 Evaluation Kit" into the CD-ROM drive.
4. Access the CD-ROM drive and double-click the icon of "akd4569.exe" to set up the control program.
5. Then please evaluate according to the followings.

■ Operation flow

Keep the following flow.

1. Set up the control program.
2. Click "Port Setup" button.
3. Then set up the dialog and input data.

■ Explanation of each buttons

1. [Port Setup] : set up the printer port.
2. [Write default] : initialize the register of AK4569.
3. [Function1] : Dialog to write data by keyboard operation.
4. [Function2] : Dialog to evaluate IPGA and ATTL/ATTR/ATTM.
5. [Write] : write data to each register.

■ Explanation of each dialog

1. [Function1 Dialog] : Dialog to write data by keyboard operation

Address Box: Input register address in 2 figures of hexadecimal.

Data Box: Input register data in 2 figures of hexadecimal.

If you want to write the input data to AK4569, click “OK” button. If not, click “Cancel” button.

2. [Function2 Dialog] : Dialog to evaluate IPGA and ATTL/ATTR/ATTM

This dialog corresponds to only addr=05H, 0AH, 0BH and 0CH.

Address Box: Input register address in 2 figures of hexadecimal.

Start Data Box: Input start data in 2 figures of hexadecimal.

End Data Box: Input end data in 2 figures of hexadecimal.

Interval Box: Data is written to AK4569 by this interval.

Step Box: Data changes by this step.

Mode Select Box:

If you check this check box, data reaches end data, and returns to start data.

[Example] Start Data = 00, End Data = 09

Data flow: 00 01 02 03 04 05 06 07 08 09 09 08 07 06 05 04 03 02 01 00

If you do not check this check box, data reaches end data, but does not return to start data.

[Example] Start Data = 00, End Data = 09

Data flow: 00 01 02 03 04 05 06 07 08 09

If you want to write the input data to AK4569, click “OK” button. If not, click “Cancel” button.

3. [Write Dialog] : Dialog to write data by mouse operation

There are dialogs corresponding to each register.

Click the “Write” button corresponding to each register to set up the dialog. If you check the check box, data becomes “H” or “1”. If not, “L” or “0”.

If you want to write the input data to AK4569, click “OK” button. If not, click “Cancel” button.

■ Indication of data

Input data is indicated on the register map. Red letter indicates “H” or “1” and blue one indicates “L” or “0”. Blank is the part that is not defined in the datasheet.

■ Attention on the operation

If you set up Function1 or Function2 dialog, input data to all boxes. Attention dialog is indicated if you input data or address that is not specified in the datasheet or you click “OK” button before you input data. In that case set up the dialog and input data once more again. These operations does not need if you click “Cancel” button or check the check box.

AKD4116 Control Program operation manual

■ Set-up of evaluation board and control software

1. Set up the AKD4569 according to above mentioned setting.
2. Connect IBM-AT compatible PC with AKD4569 by 10-line type flat cable (packed with AKD4569). Take care of the direction of 10pin header. (Please install the driver in the floppy-disk when this control software is used on Windows 2000/XP. Please refer "Installation Manual of Control Software Driver by AKM device control software". In case of Windows95/98/ME, this installation is not needed. This control software does not operate on Windows NT.)
3. Insert the CD-ROM labeled "AK4569 Evaluation Kit" into the CD-ROM drive.
4. Access the CD-ROM drive and double-click the icon of "akd4116_1.exe" and "akd4116_2.exe" to set up the control program.
5. Then please evaluate according to the follows.

■ Operation flow

Keep the following flow.

1. Set up the control program.
2. Click "Port Setup" button.
3. Then set up the dialog and input data.

■ Explanation of each buttons

1. [Port Setup] : set up the printer port.
2. [Write default] : initialize the register of AK4116.
3. [All read] : read all registers.
4. [Read] : read data from each register.
5. [Write] : write data to each register.

If you want to write the input data to AK4116, click "OK" button. If not, click "Cancel" button.

■ Indication of data

Input data is indicated on the register map. Red letter indicates "H" or "1" and blue one indicates "L" or "0". Blank is the part that is not defined in the datasheet.

End.

MEASUREMENT RESULTS

1) ADC part

[Measurement condition]

- Measurement unit : Audio Precision System two Cascade
- MCLK : 256fs
- BICK : 64fs
- fs : 48kHz
- BW : 10Hz~20kHz
- Bit : 20bit
- Power Supply : AVDD=DVDD=HVDD=3V
- Interface : DIT
- Temperature : Room

Parameter	Input signal	Measurement filter	Results
S/(N+D)	1kHz, -1dB	20kLPF	85.1dB
DR	1kHz, -60dB	20kLPF, A-weighted	88.6dB
S/N	No signal	20kLPF, A-weighted	88.6dB

2) DAC part

[Measurement condition]

- Measurement unit : Audio Precision System two Cascade
- MCLK : 256fs
- BICK : 64fs
- fs : 48kHz
- BW : 10Hz~20kHz
- Bit : 20bit
- Power Supply : AVDD=DVDD=HVDD=3V
- Interface : DIR
- Temperature : Room

Parameter	Input signal	Measurement filter	HP-amp	MOUT
S/(N+D)	1kHz, 0dB	20kLPF	69.5dB	85.7dB
DR	1kHz, -60dB	22kLPF, A-weighted	90.8dB	90.3dB
S/N	"0" data	22kLPF, A-weighted	91.2dB	90.9dB

■ Plots

(1) ADC part

[Measurement condition]

- Measurement unit : Audio Precision, System two, Cascade
- MCLK : 256fs
- BICK : 64fs
- fs : 48kHz
- BW : 10Hz~20kHz
- Bit : 20bit
- Power Supply : AVDD=DVDD=HVDD=3V
- Interface : DIT
- Temperature : Room

Figure 4. FFT (1kHz, -1dBFS input)

Figure 5. FFT (1kHz, -60dBFS input)

Figure 6. FFT (Noise floor)

Figure 7. THD+N vs Input Level (fin=1kHz)

Figure 8. THD+N vs fin (Input Level=-1dBFS)

Figure 9. Linearity (fin=1kHz)

Figure 10. Frequency Response (Input Level=-1dBFS)

Figure 11. Crosstalk (Input Level=-1dBFS)

(ADC)

AKM

AK4569 ADC FFT (fs=44.1kHz, fin=1kHz, -1dB Input)
 FFT point=16384, Avg=8, window=Equiripple

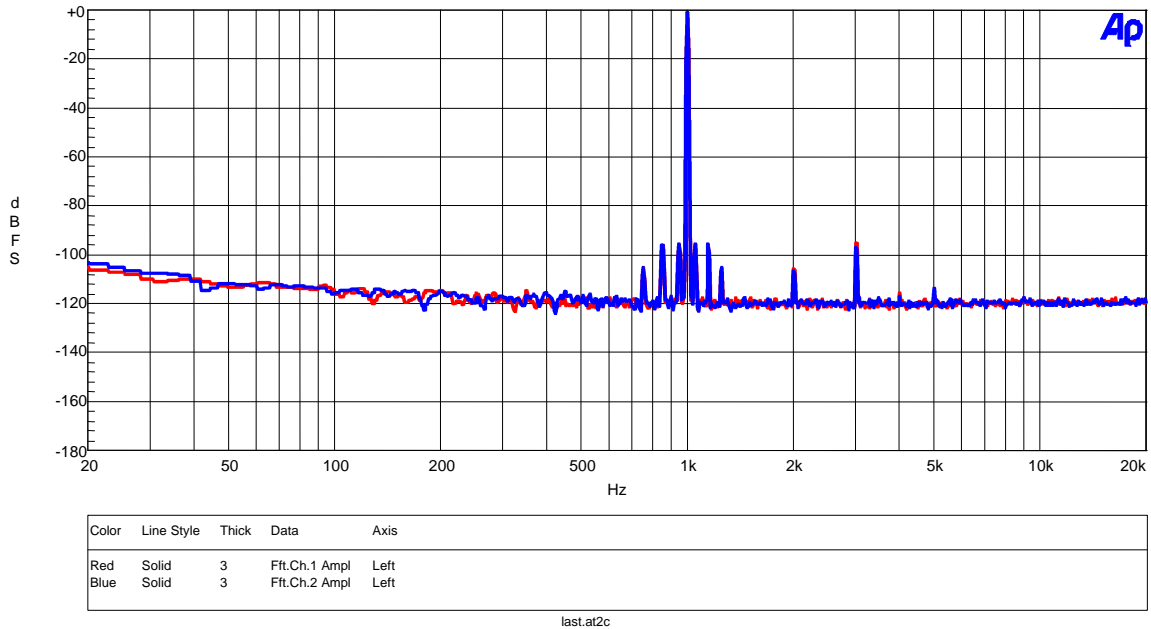

Figure 4. FFT (1kHz, -1dBFS input)
 FFT points=16384, Avg=8, Window=Equiripple

AKM

AK4569 ADC FFT (fs=44.1kHz, fin=1kHz, -60dB Input)
 FFT point=16384, Avg=8, window=Equiripple

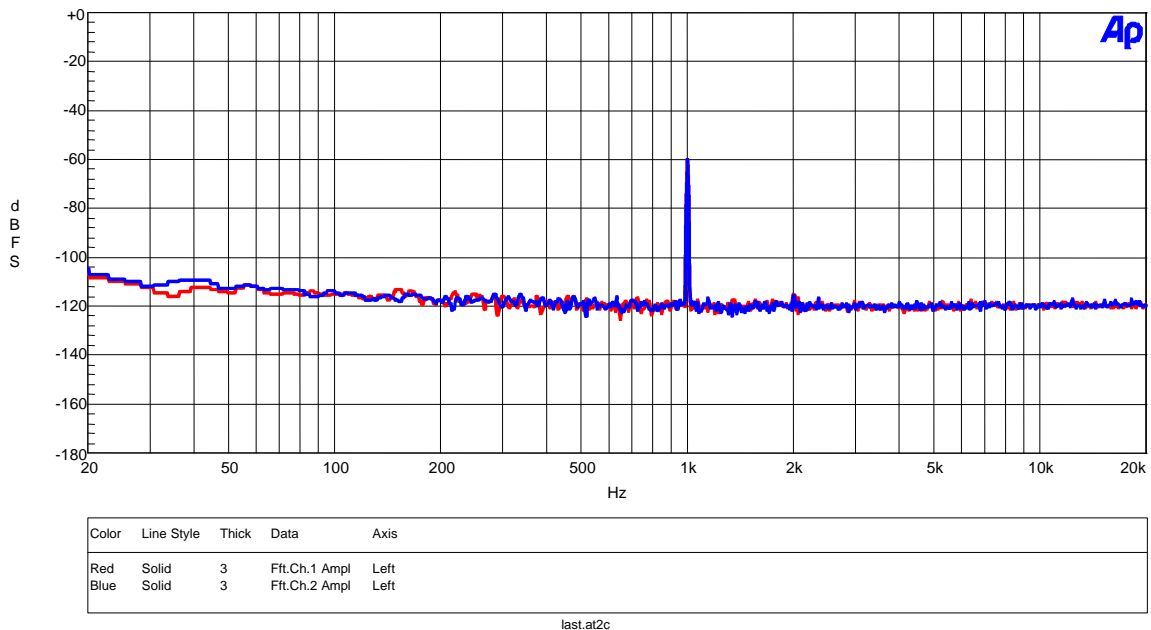

Figure 5. FFT (1kHz, -60dBFS input)
 FFT points=16384, Avg=8, Window=Equiripple

(ADC)

AKM

AK4569 ADC FFT (No signal Input)
FFT point=16384, Avg=8, window=Equiripple

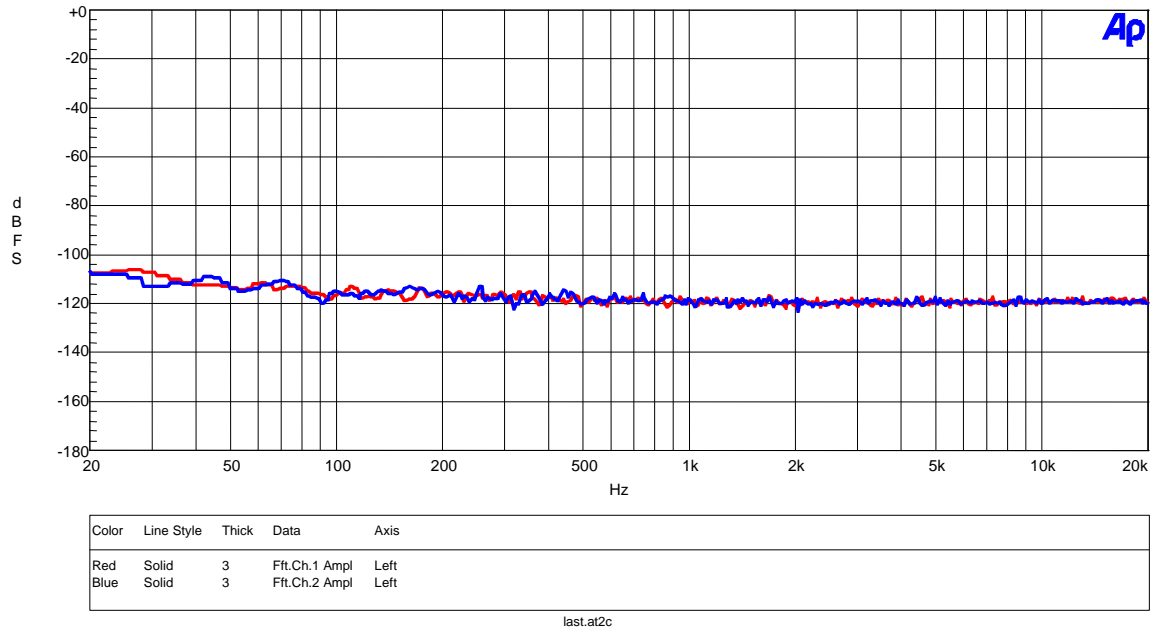

Figure 6. FFT (Noise floor)
FFT points=16384, Avg=8, Window=Equiripple

(ADC)

AKM

AK4569 DAC THD+N vs. Input Level (fs=44.1kHz, fin=1kHz)

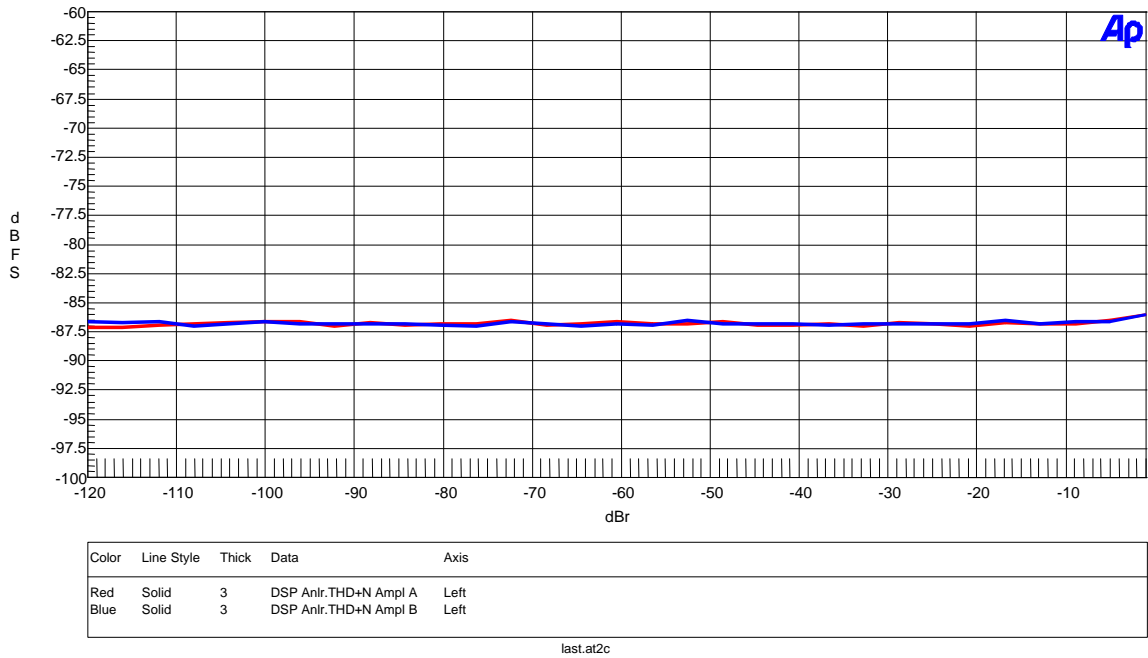

Figure 7. THD+N vs Input Level (fin=1kHz)

AKM

AK4569 ADC THD+N vs. fin (fs=44.1kHz, -1dBFS Input)

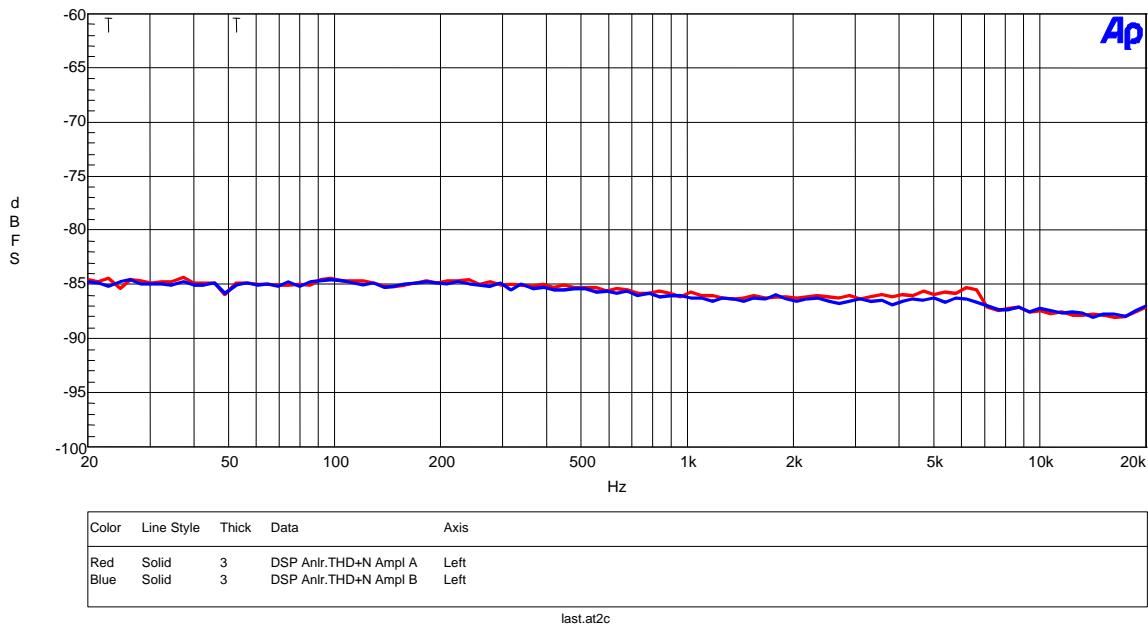

Figure 8. THD+N vs fin (Input Level=-1dBFS)

(ADC)

AKM

AK4569 DAC Linearity (fs=44.1kHz, fin=1kHz)

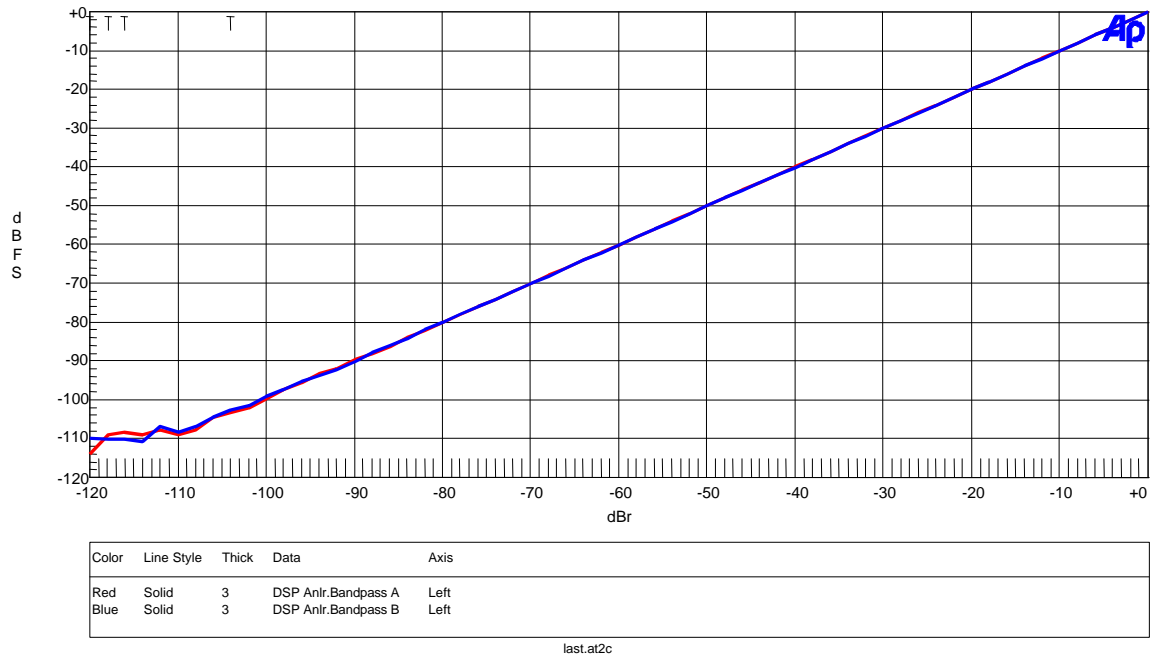

Figure 9. Linearity (fin=1kHz)

AKM

AK4569 ADC Frequency Response (fs=48kHz, -1dBFS Input)

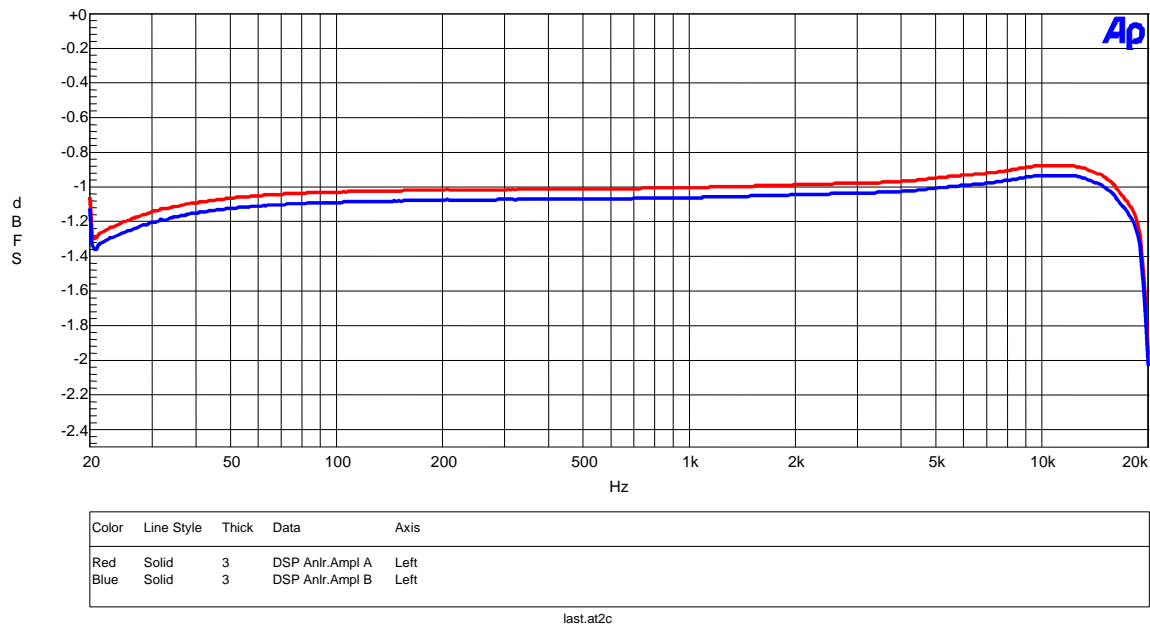

Figure 10. Frequency Response (Input Level=-1dBFS)

(ADC)

AKM

AK4569 ADC Crosstalk (fs=44.1kHz, fin=1kHz, -1dBFS
Upper@1kHz;Lch--->Rch, Lower@1kHz;Rch--->Lch

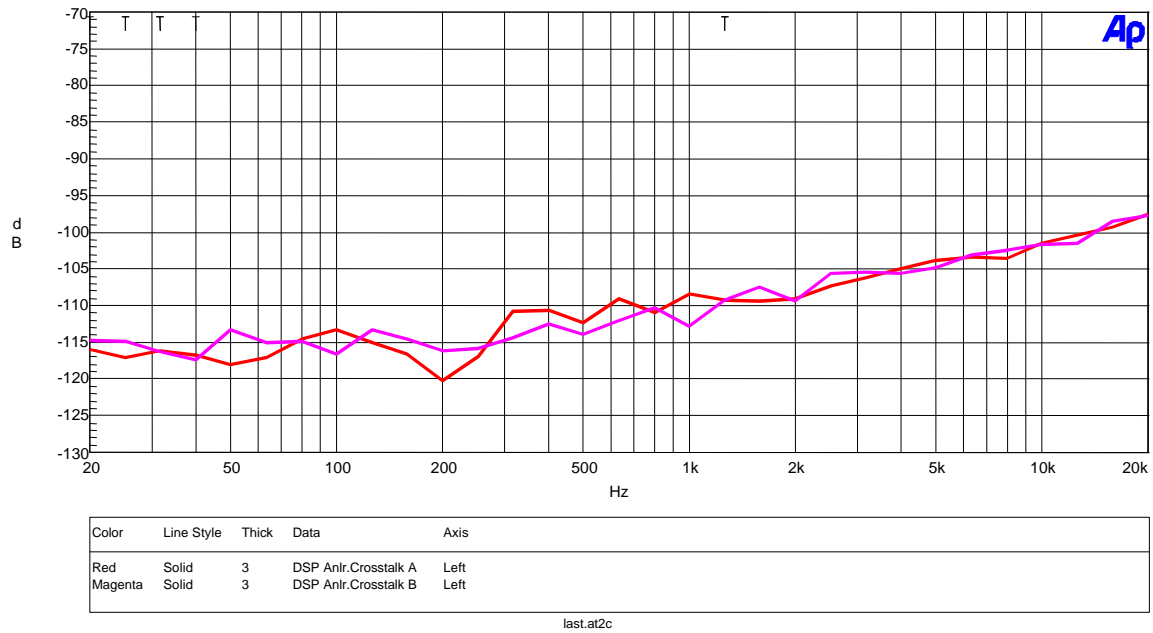

Figure 11. Crosstalk (Input Level=-1dBFS)

(2) DAC part (HPL, HPR pins)

[Measurement condition]

- Measurement unit : Audio Precision, System two, Cascade
- MCLK : 256fs
- BICK : 64fs
- fs : 48kHz
- BW : 10Hz~20kHz
- Bit : 20bit
- Power Supply : AVDD=DVDD=HVDD=3V
- Interface : DIR
- Temperature : Room

Figure 12. FFT (1kHz, 0dBFS input)

Figure 13. FFT (1kHz, -60dBFS input)

Figure 14. FFT (Noise floor)

Figure 15. FFT (Outband noise)

Figure 16. THD+N vs Input Level (fin=1kHz)

Figure 17. THD+N vs fin (Input Level=0dBFS)

Figure 18. Linearity (fin=1kHz)

Figure 19. Frequency Response (Input Level=0dBFS)

Figure 20. Crosstalk (Input Level=0dBFS)

(DAC)

AKM

AK4569 DAC FFT (fs=44.1kHz, fin=1kHz, 0dBFS Input)
 FFT point=16384, Avg=8, window=Equiripple

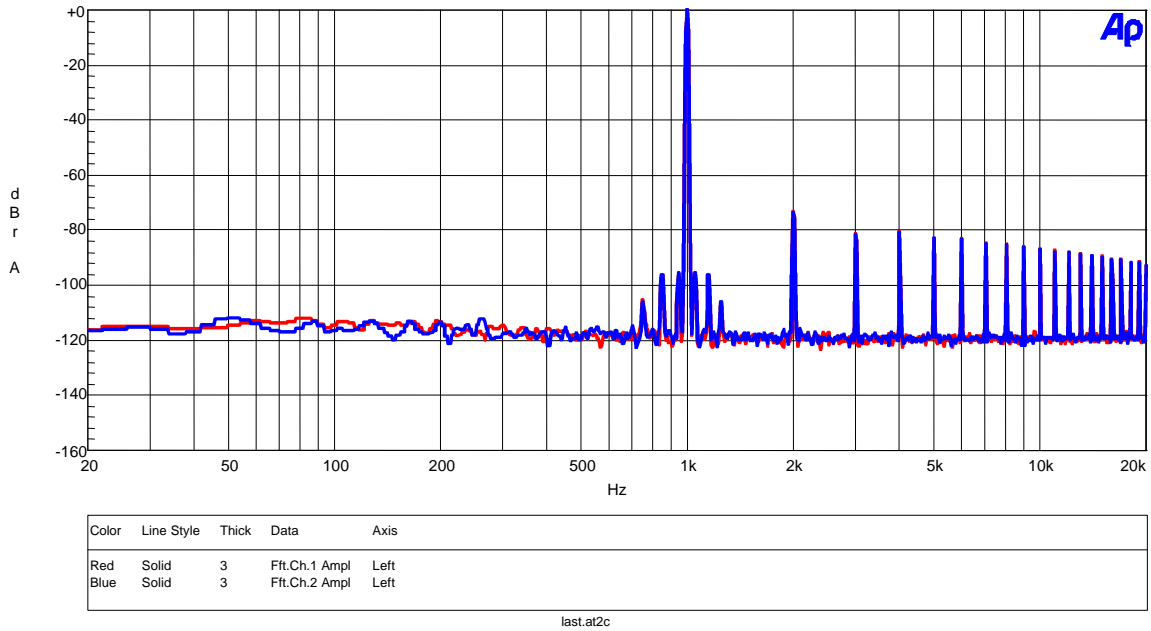

Figure 12. FFT (1kHz, 0dBFS input)
 FFT points=16384, Avg=8, Window=Equiripple

AKM

AK4569 DAC FFT (fs=44.1kHz, fin=1kHz, -60dBFS Input)
 FFT point=16384, Avg=8, window=Equiripple

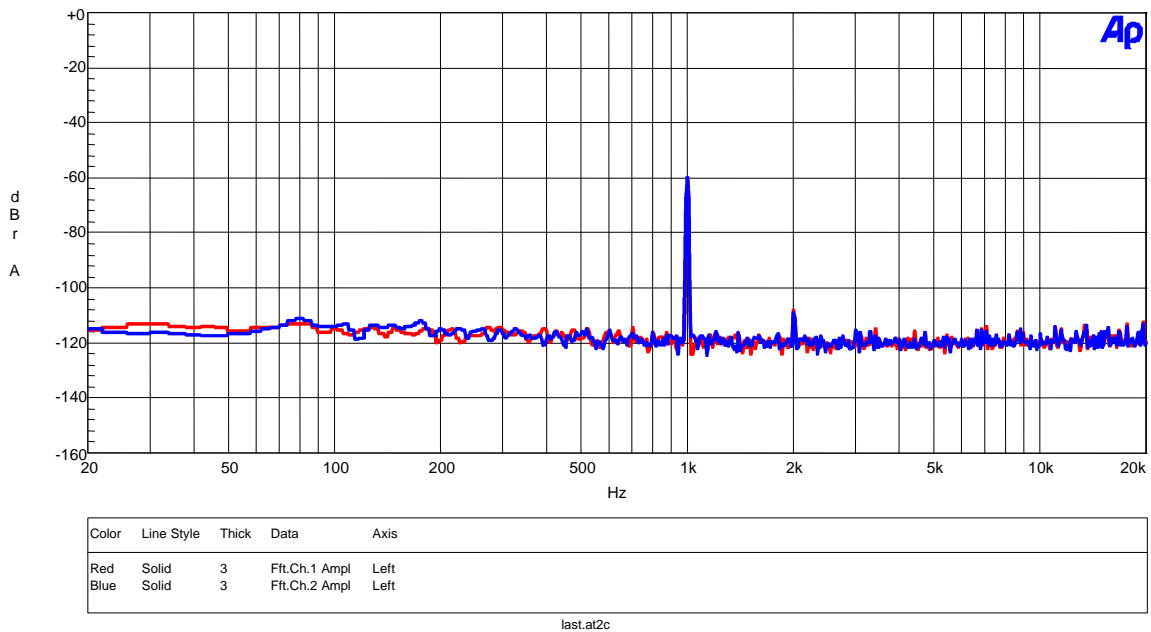

Figure 13. FFT (1kHz, -60dBFS input)
 FFT points=16384, Avg=8, Window=Equiripple

(DAC)

AKM

AK4569 DAC FFT (No data Input)
 FFT point=16384, Avg=8, window=Equiripple

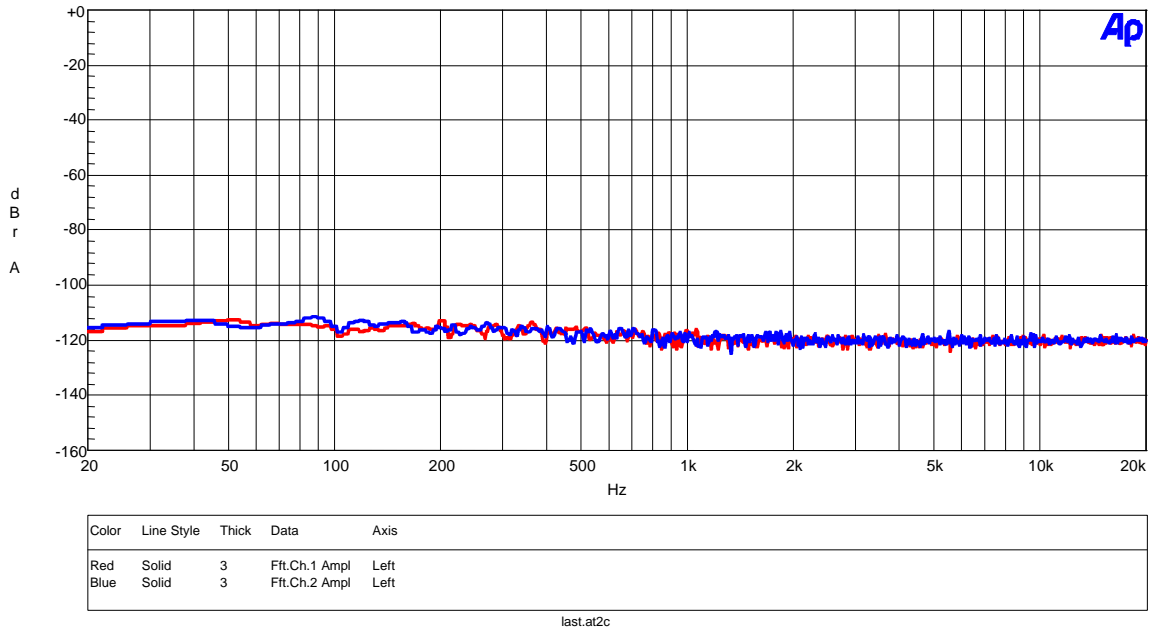

Figure 14. FFT (Noise floor)
 FFT points=16384, Avg=8, Window=Equiripple

AKM

AK4569 DAC FFT (Out-band-noise)
 FFT point=16384, Avg=8, window=Equiripple

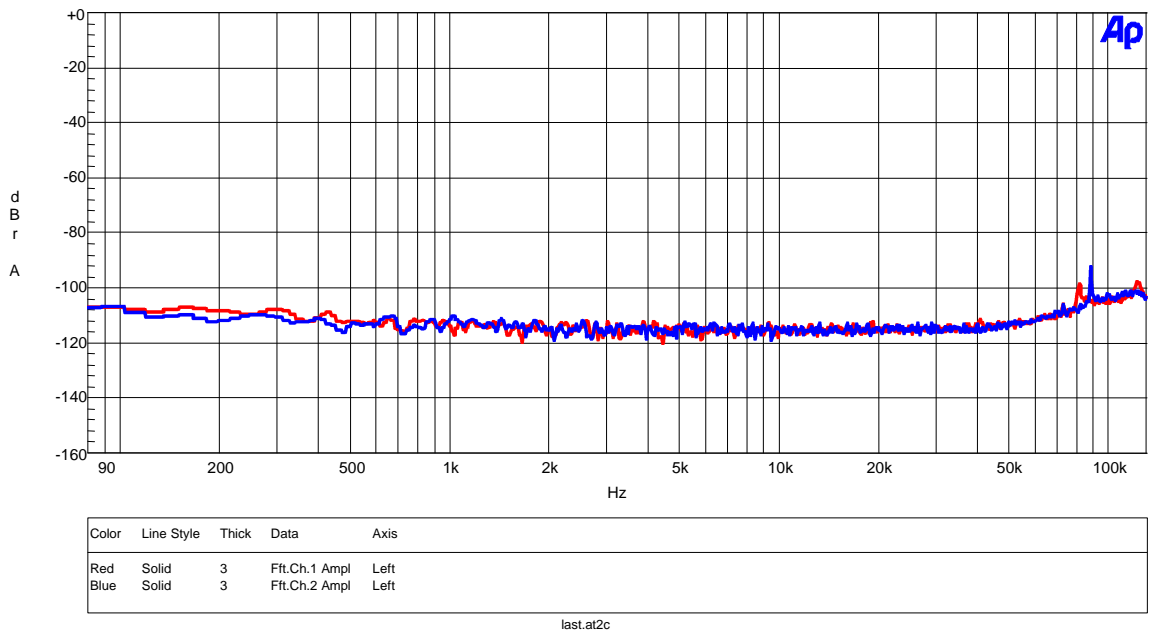

Figure 15. FFT (Outband noise)
 FFT points=16384, Avg=8, Window=Equiripple

(DAC)

AKM

AK4569 DAC THD+N vs. Input Level (fs=44.1kHz, fin=1kHz)

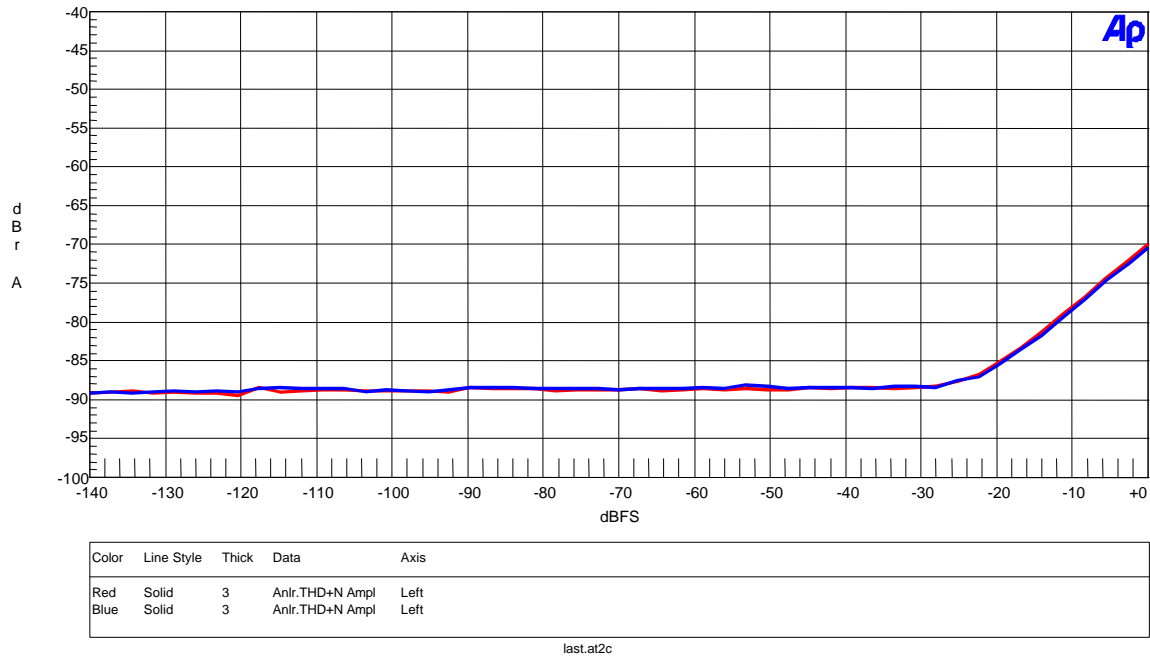

Figure 16. THD+N vs Input Level (fin=1kHz)

AKM

AK4569 DAC THD+N vs. Input Frequency (fs=44.1kHz, fin=1kHz, Input Level=0dBFS)

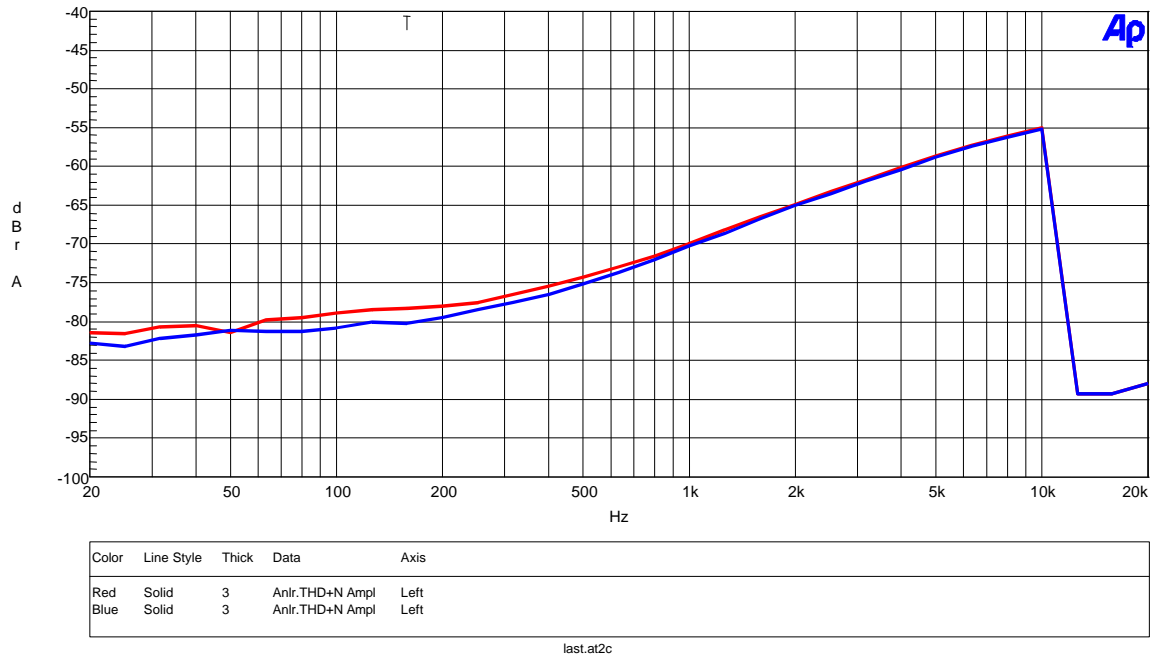

Figure 17. THD+N vs fin (Input Level=0dBFS)

(DAC)

AKM

AK4569 DAC Linearity (fs=44.1kHz,fin=1kHz)

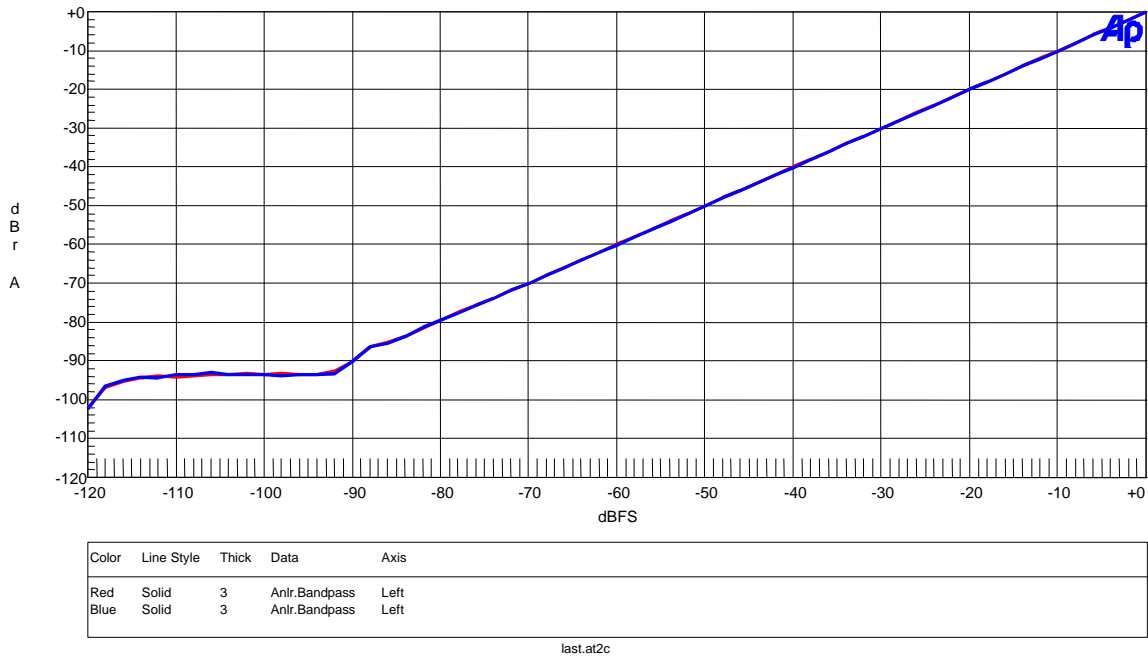

Figure 18. Linearity (fin=1kHz)

AKM

AK4569 DAC Frequency Response (fs=44.1kHz,Input Level=0dB)

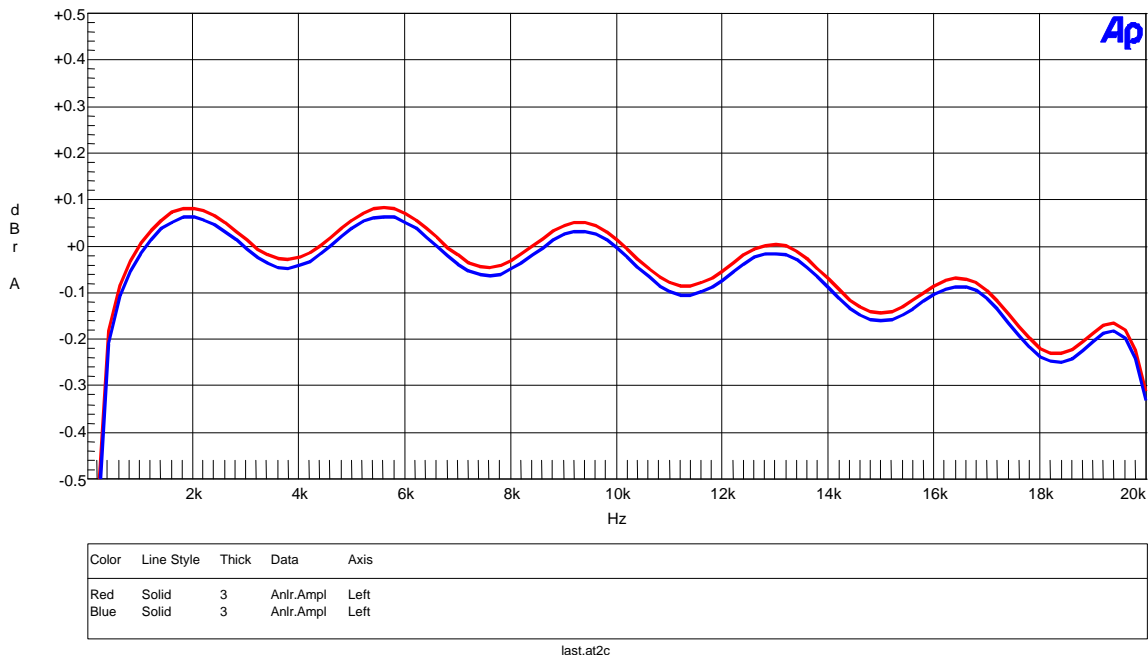

Figure 19. Frequency Response (Input Level=0dBFS)

(DAC)

AKM

AK4569 DAC Crosstalk (fs=44.1kHz, Input Level=0dB)
Upper@1kHz Lch--->Rch, Lower@1kHz Rch--->Lch

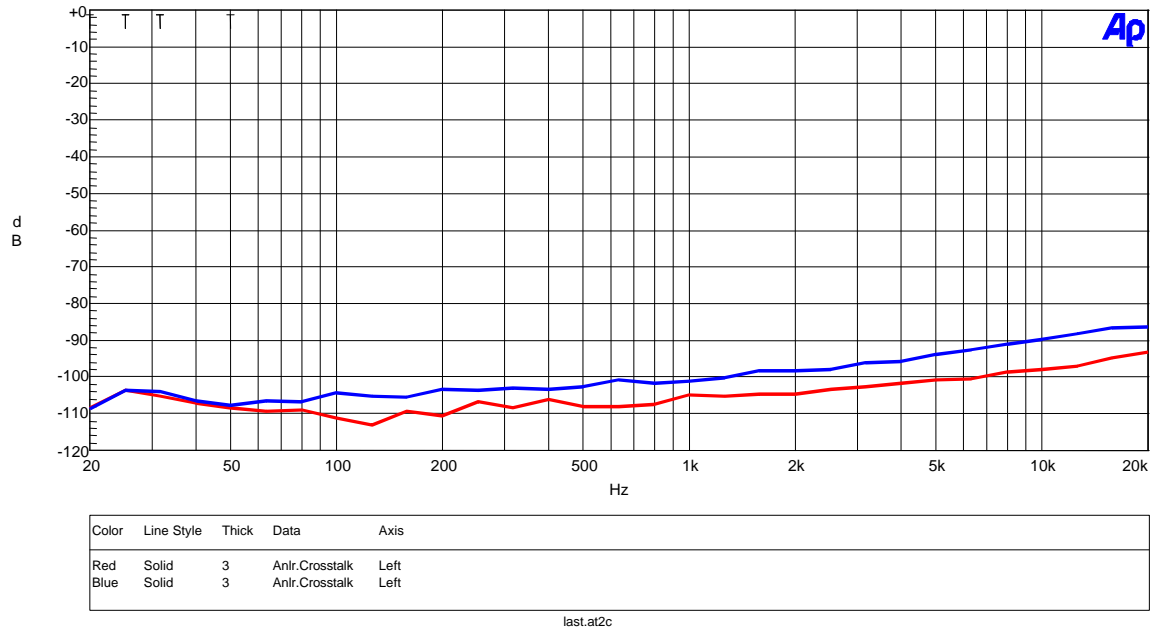
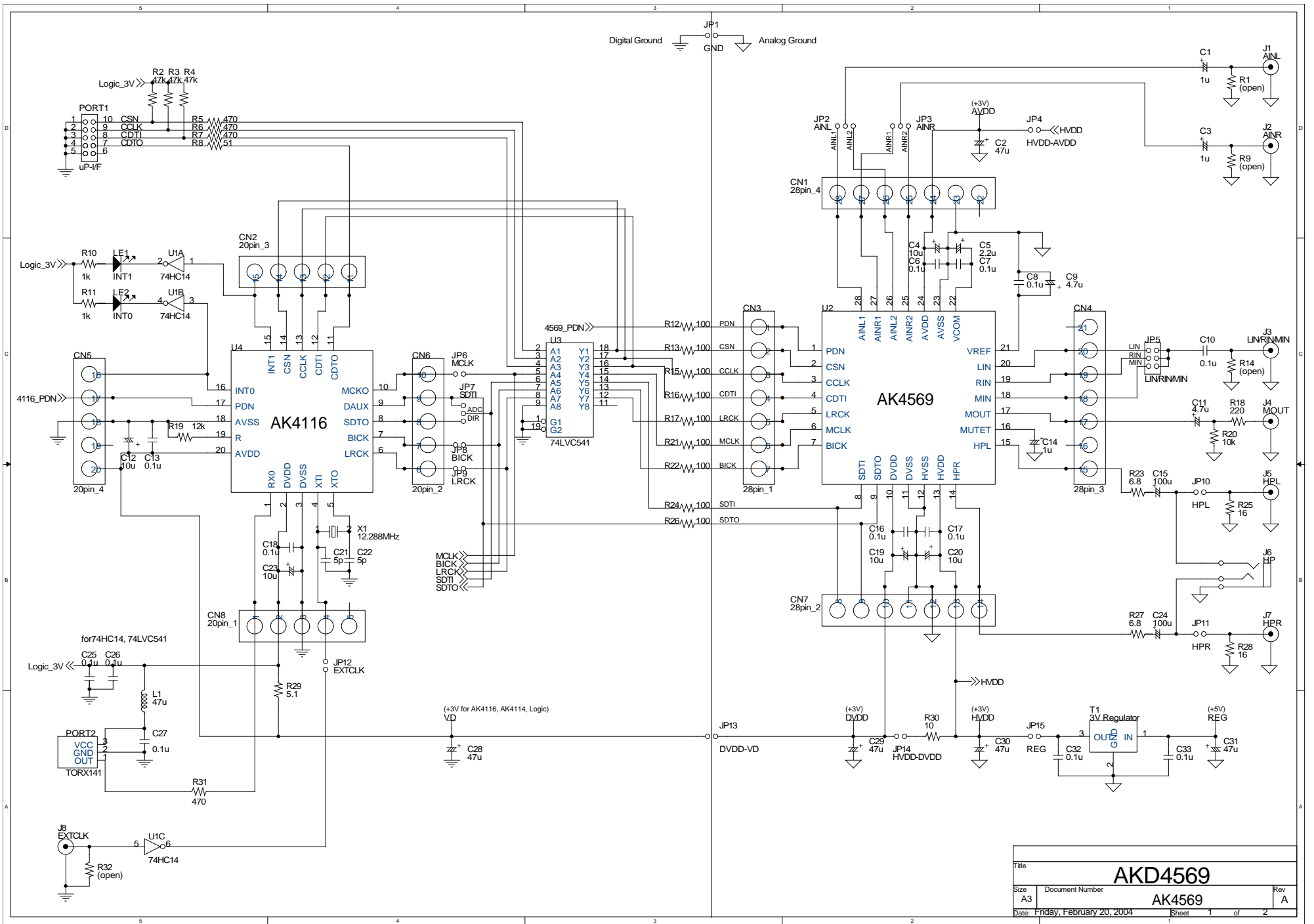
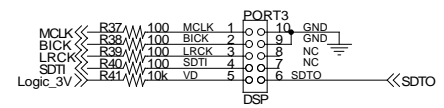
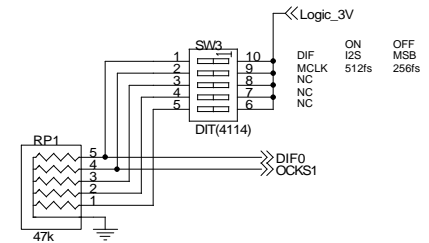
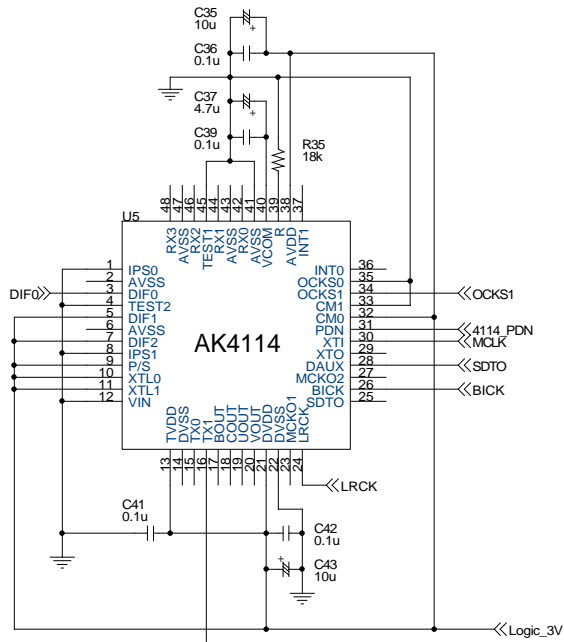
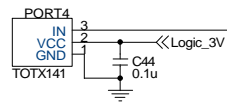
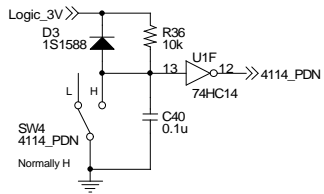
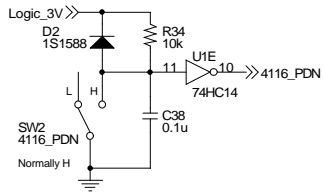
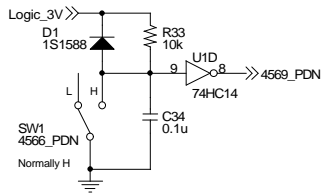

Figure 20. Crosstalk (Input Level=0dBFS)

IMPORTANT NOTICE

- These products and their specifications are subject to change without notice. Before considering any use or application, consult the Asahi Kasei Microsystems Co., Ltd. (AKM) sales office or authorized distributor concerning their current status.
- AKM assumes no liability for infringement of any patent, intellectual property, or other right in the application or use of any information contained herein.
- Any export of these products, or devices or systems containing them, may require an export license or other official approval under the law and regulations of the country of export pertaining to customs and tariffs, currency exchange, or strategic materials.
- AKM products are neither intended nor authorized for use as critical components in any safety, life support, or other hazard related device or system, and AKM assumes no responsibility relating to any such use, except with the express written consent of the Representative Director of AKM. As used here:
 - (a) A hazard related device or system is one designed or intended for life support or maintenance of safety or for applications in medicine, aerospace, nuclear energy, or other fields, in which its failure to function or perform may reasonably be expected to result in loss of life or in significant injury or damage to person or property.
 - (b) A critical component is one whose failure to function or perform may reasonably be expected to result, whether directly or indirectly, in the loss of the safety or effectiveness of the device or system containing it, and which must therefore meet very high standards of performance and reliability.
- It is the responsibility of the buyer or distributor of an AKM product who distributes, disposes of, or otherwise places the product with a third party to notify that party in advance of the above content and conditions, and the buyer or distributor agrees to assume any and all responsibility and liability for and hold AKM harmless from any and all claims arising from the use of said product in the absence of such notification.





Title		AKD4569	
Size	Document Number	Interface	
A3		Rev A	
Date: Friday, February 20, 2004		Sheet	2 of 2

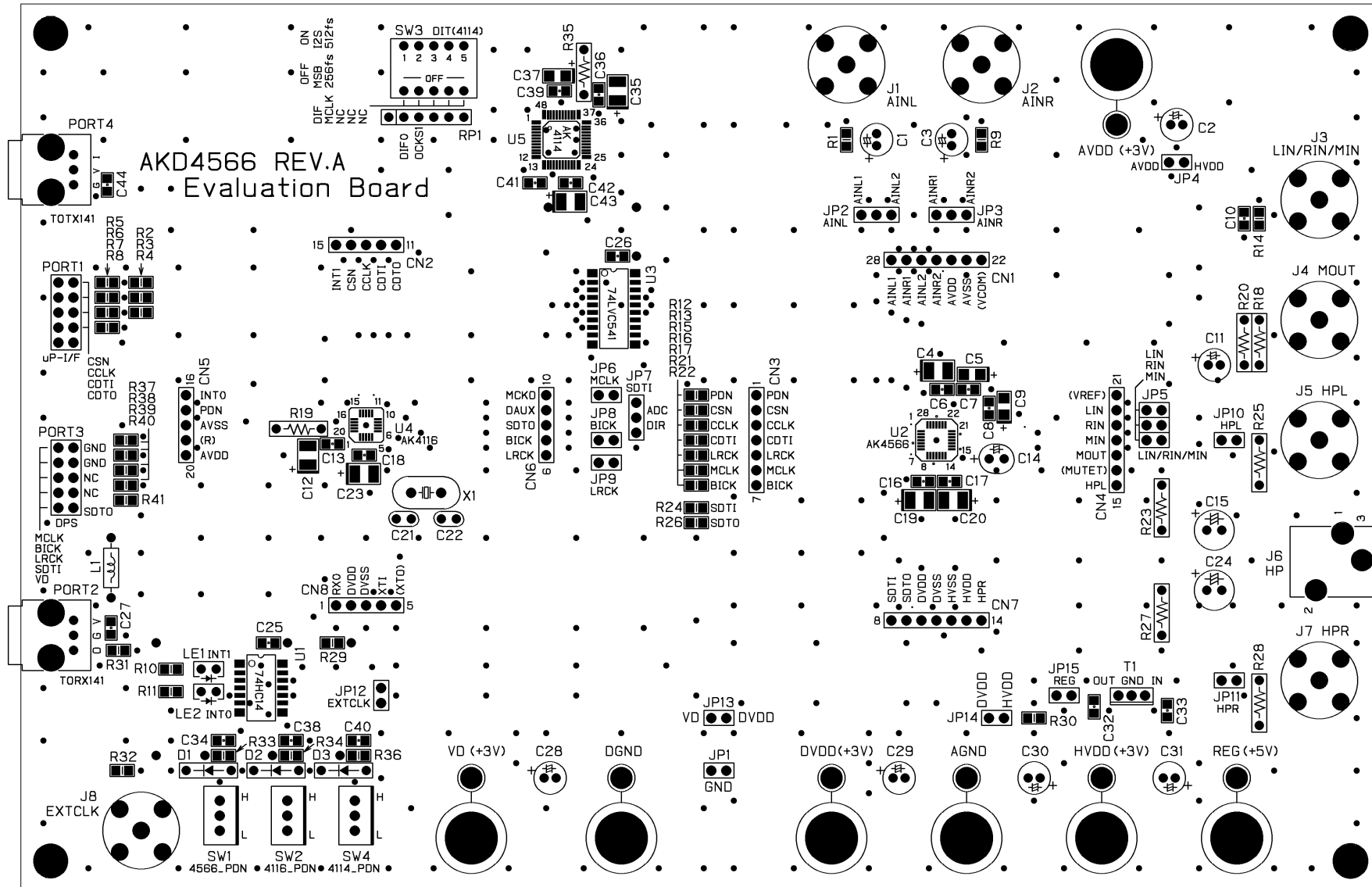

AKD4566 Rev.A L1 SR SILK

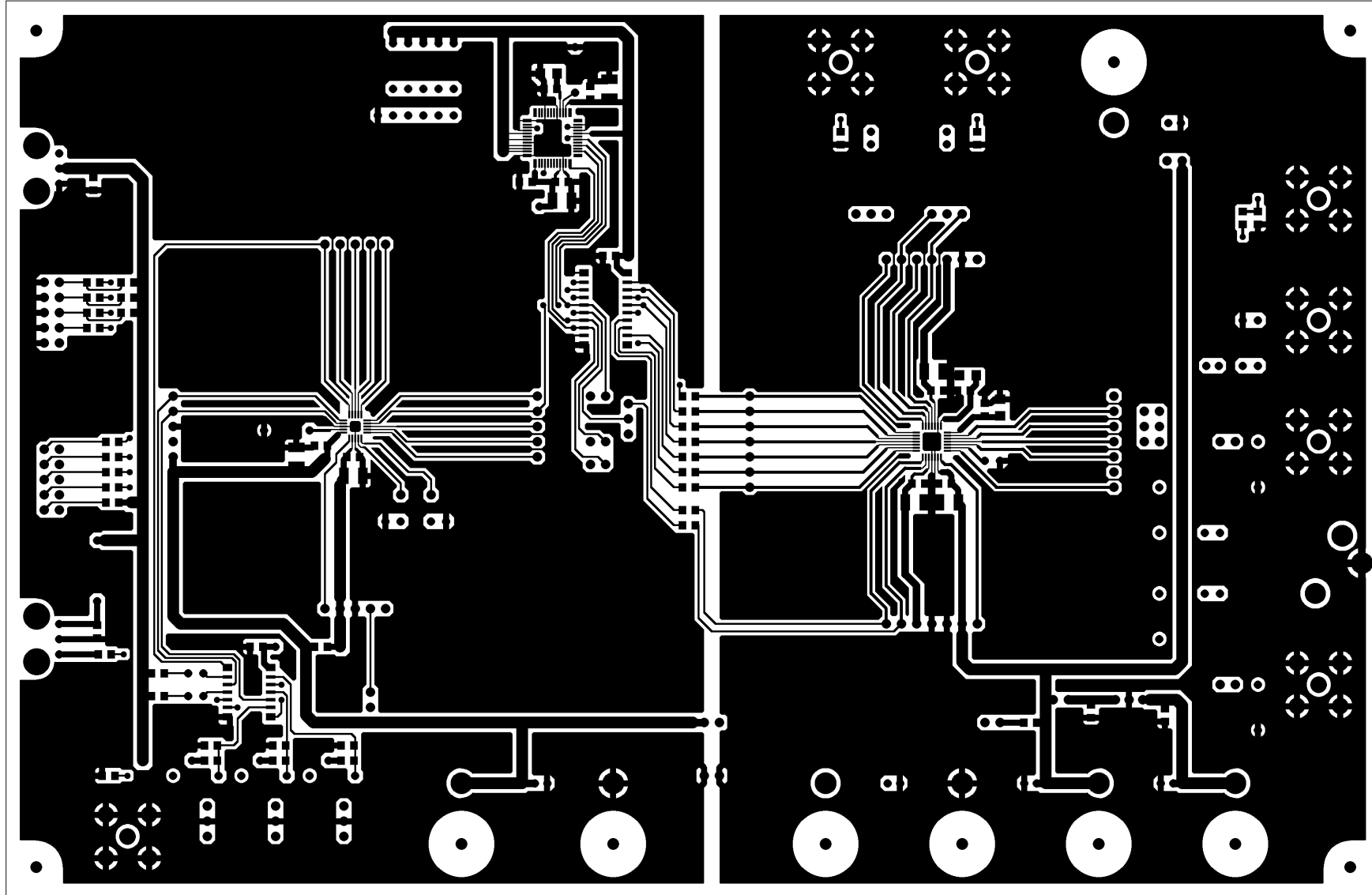

AKD4566 Rev.A L1

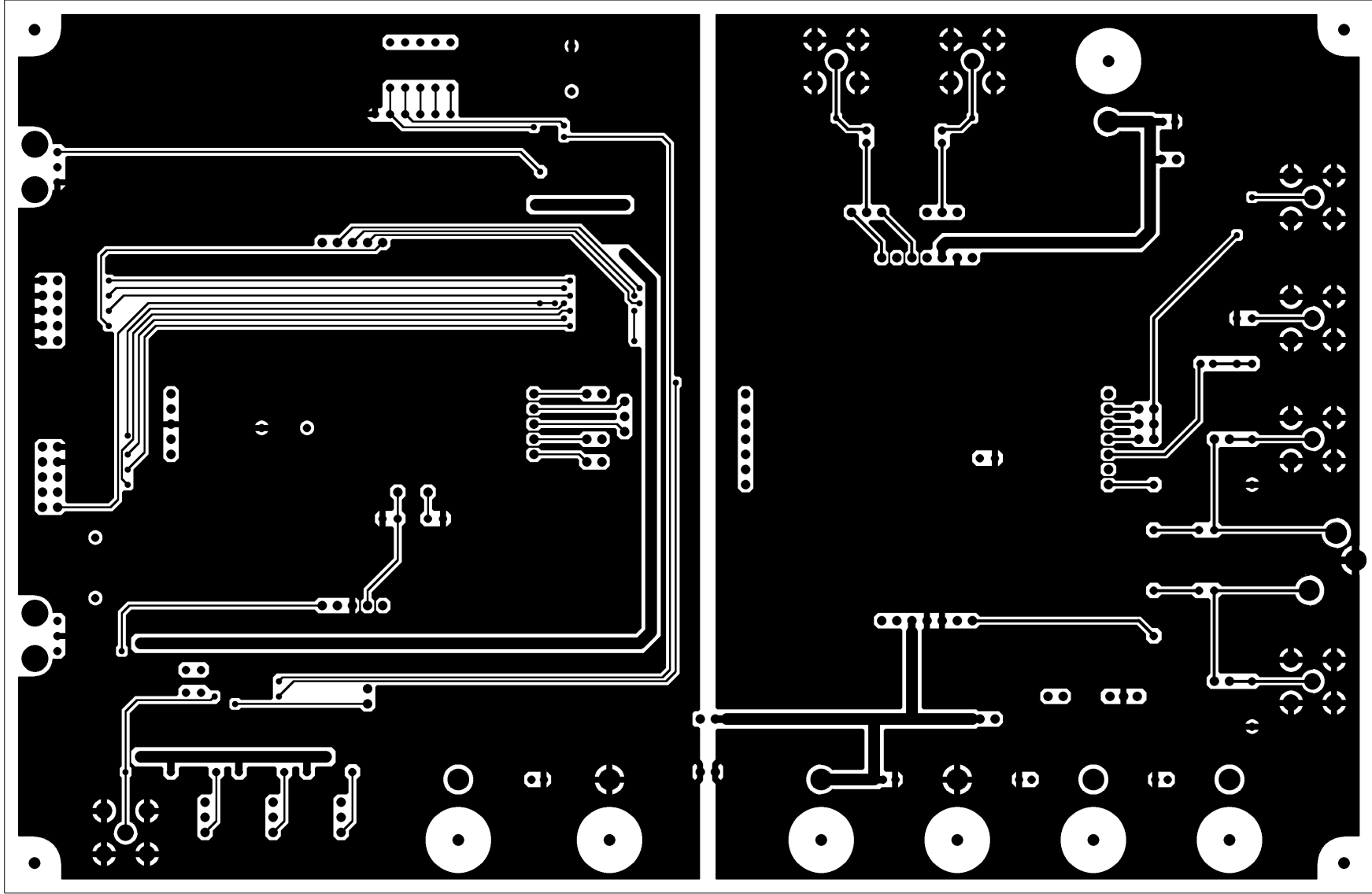

AKD4266 Rev.A LS