

NPN Silicon Digital Transistor

Preliminary data

- Switching circuit, inverter, interface circuit, driver circuit
- Built in bias resistor ($R_1=4.7k\Omega$)

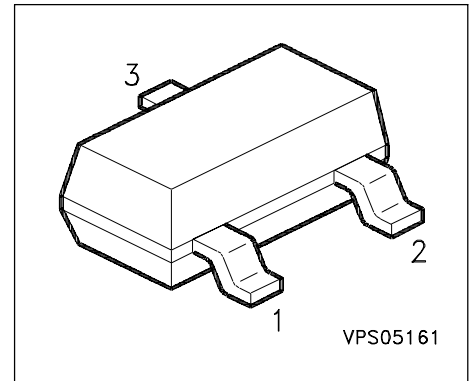
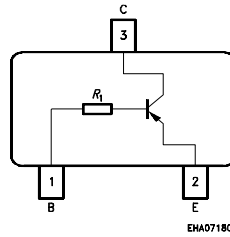

| Type | Marking | Ordering Code | Pin Configuration | | | Package |
|---------|---------|---------------|-------------------|-------|-------|---------|
| | | | 1 = B | 2 = E | 3 = C | |
| BCR 129 | WVs | Q62702- | 1 = B | 2 = E | 3 = C | SOT-23 |

Maximum Ratings

| Parameter | Symbol | Values | Unit |
|--|-------------|----------------|------------------|
| Collector-emitter voltage | V_{CEO} | 50 | V |
| Collector-base voltage | V_{CBO} | 50 | |
| Emitter-base voltage | V_{EBO} | 5 | |
| Input on Voltage | $V_{i(on)}$ | 20 | |
| DC collector current | I_C | 100 | mA |
| Total power dissipation, $T_S = 102^\circ\text{C}$ | P_{tot} | 200 | mW |
| Junction temperature | T_j | 150 | $^\circ\text{C}$ |
| Storage temperature | T_{stg} | - 65 ... + 150 | |

Thermal Resistance

| | | | |
|--------------------------------|------------|------------|-----|
| Junction ambient ¹⁾ | R_{thJA} | ≤ 350 | K/W |
| Junction - soldering point | R_{thJS} | ≤ 240 | |

1) Package mounted on pcb 40mm x 40mm x 1.5mm / 6cm² Cu

Electrical Characteristics at $T_A=25^\circ\text{C}$, unless otherwise specified

| Parameter | Symbol | Values | | | Unit |
|-----------|--------|--------|------|------|------|
| | | min. | typ. | max. | |

DC Characteristics

| | | | | | |
|--|---------------|-----|----|-----|------------|
| Collector-emitter breakdown voltage $I_C = 100 \mu\text{A}, I_B = 0$ | $V_{(BR)CEO}$ | 50 | - | - | V |
| Collector-base breakdown voltage $I_C = 10 \mu\text{A}, I_B = 0$ | $V_{(BR)CBO}$ | 50 | - | - | |
| Base-emitter breakdown voltage $I_E = 10 \mu\text{A}, I_C = 0$ | $V_{(BR)EBO}$ | 5 | - | - | |
| Collector cutoff current $V_{CB} = 40 \text{ V}, I_E = 0$ | I_{CBO} | - | - | 100 | nA |
| DC current gain $I_C = 5 \text{ mA}, V_{CE} = 5 \text{ V}$ | h_{FE} | 120 | - | 630 | - |
| Collector-emitter saturation voltage 1) $I_C = 10 \text{ mA}, I_B = 0.5 \text{ mA}$ | V_{CEsat} | - | - | 0.3 | V |
| Input off voltage $I_C = 100 \mu\text{A}, V_{CE} = 5 \text{ V}$ | $V_{i(off)}$ | 0.4 | - | 1 | |
| Input on Voltage $I_C = 2 \text{ mA}, V_{CE} = 0.3 \text{ V}$ | $V_{i(on)}$ | 0.5 | - | 1.1 | |
| Input resistor | R_1 | 7 | 10 | 13 | k Ω |

AC Characteristics

| | | | | | |
|--|----------|---|-----|---|-----|
| Transition frequency $I_C = 10 \text{ mA}, V_{CE} = 5 \text{ V}, f = 100 \text{ MHz}$ | f_T | - | 150 | - | MHz |
| Collector-base capacitance $V_{CB} = 10 \text{ V}, f = 1 \text{ MHz}$ | C_{cb} | - | 3 | - | pF |

1) Pulse test: $t < 300\mu\text{s}$; $D < 2\%$

DC Current Gain $h_{FE} = f(I_C)$

$V_{CE} = 5V$ (common emitter configuration)

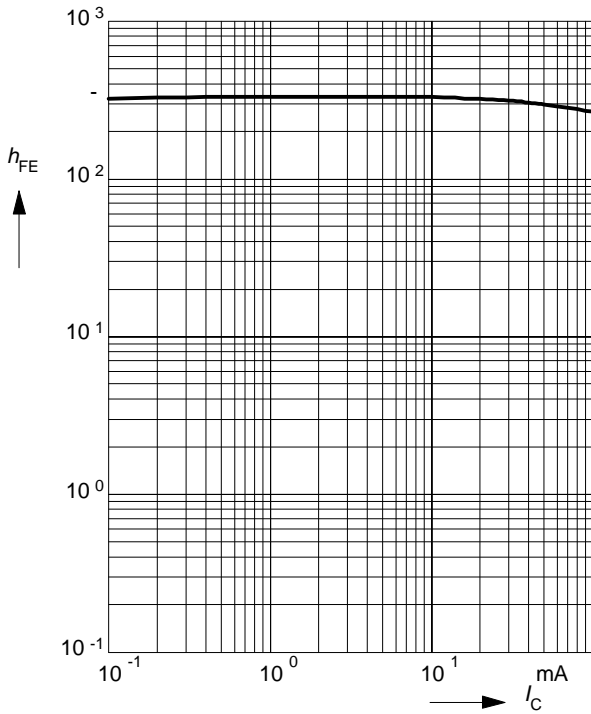

Collector-Emitter Saturation Voltage

$V_{CEsat} = f(I_C), h_{FE} = 20$

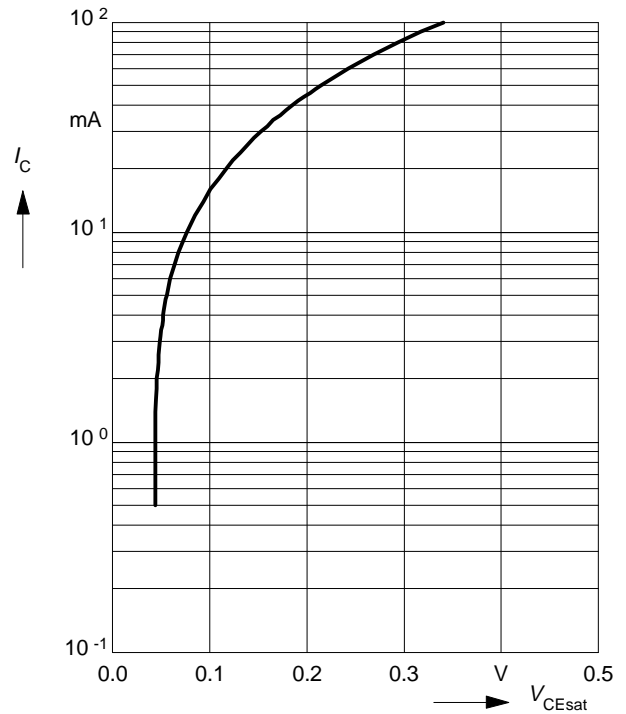

Input on Voltage $V_{i(on)} = f(I_C)$

$V_{CE} = 0.3V$ (common emitter configuration)

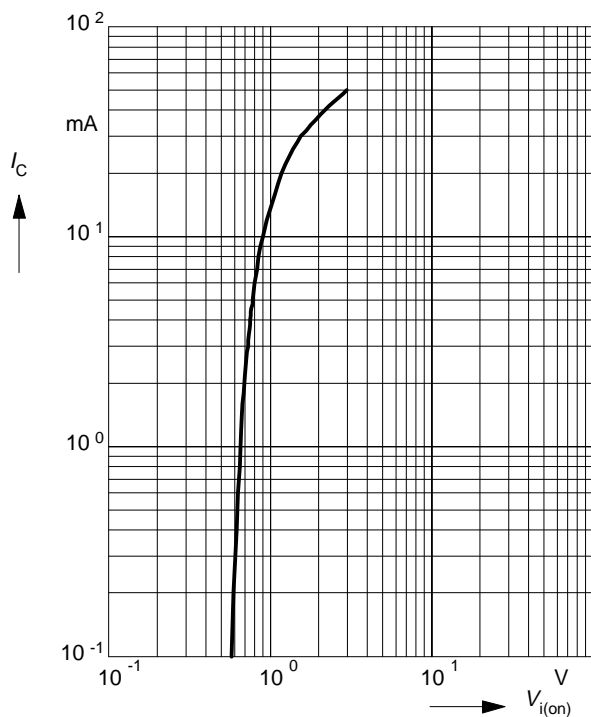

Input off voltage $V_{i(off)} = f(I_C)$

$V_{CE} = 5V$ (common emitter configuration)

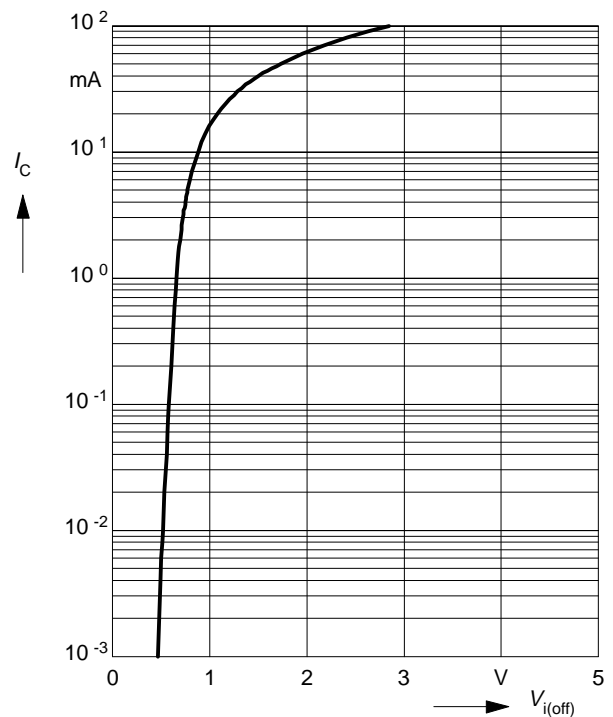

Total power dissipation $P_{tot} = f(T_A^*; T_S)$

* Package mounted on epoxy

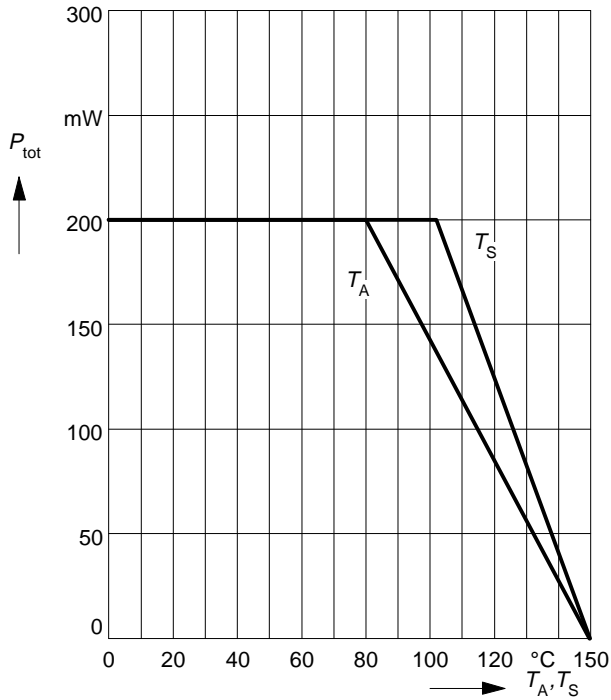

Permissible Pulse Load $R_{thJS} = f(t_p)$

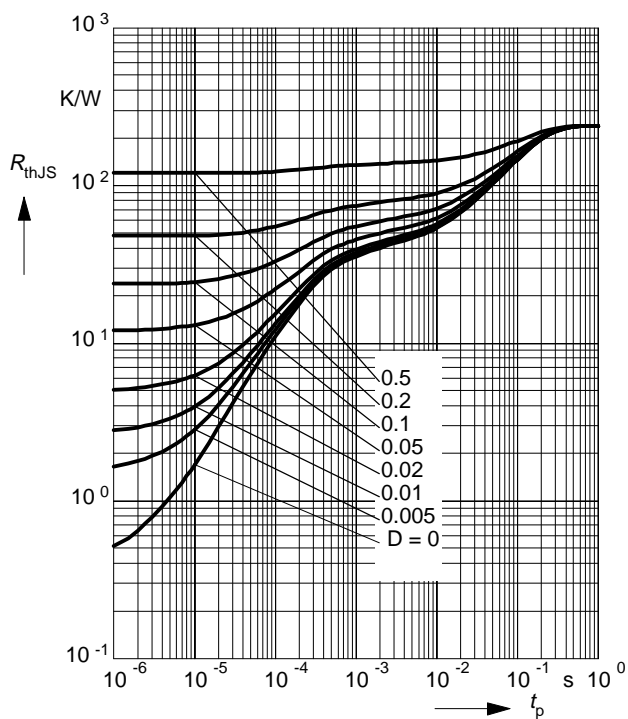

Permissible Pulse Load $P_{totmax} / P_{totDC} = f(t_p)$

