

## GENERAL DESCRIPTION

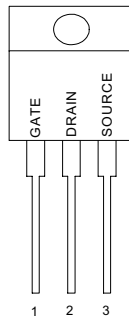
This advanced MOSFET is designed to withstand high energy in avalanche and commutation modes. The new energy efficient design also offers a drain-to-source diode with a fast recovery time. Designed for high voltage, high speed switching applications in power supplies, converters and PWM motor controls, these devices are particularly well suited for bridge circuits where diode speed and commutating safe operating areas are critical and offer additional and safety margin against unexpected voltage transients.

## FEATURES

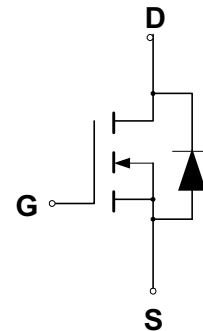
- ◆ Robust High Voltage Termination
- ◆ Avalanche Energy Specified
- ◆ Source-to-Drain Diode Recovery Time Comparable to a Discrete Fast Recovery Diode
- ◆ Diode is Characterized for Use in Bridge Circuits
- ◆  $I_{DSS}$  and  $V_{DS(on)}$  Specified at Elevated Temperature

## PIN CONFIGURATION

TO-220  
Top View



## SYMBOL



N-Channel MOSFET

## ABSOLUTE MAXIMUM RATINGS

| Rating   | Symbol         | Value      | Unit |
|--|----------------|------------|------|
| Drain to Current – Continuous  | $I_D$          | 4.0        | A    |
| – Pulsed   | $I_{DM}$       | 12         |      |
| Gate-to-Source Voltage – Continue  | $V_{GS}$       | $\pm 20$   | V    |
| – Non-repetitive   | $V_{GSM}$      | $\pm 40$   | V    |
| Total Power Dissipation  | $P_D$          | 40         | W    |
| Derate above 25°C  |                | 1.75       | W/°C |
| Operating and Storage Temperature Range  | $T_J, T_{STG}$ | -55 to 150 | °C   |
| Single Pulse Drain-to-Source Avalanche Energy – $T_J = 25^\circ\text{C}$<br>( $V_{DD} = 100\text{V}, V_{GS} = 10\text{V}, I_L = 20\text{A}, L = 10\text{mH}, R_G = 25\Omega$ ) | $E_{AS}$       | 80         | mJ   |
| Thermal Resistance – Junction to Case  | $\theta_{JC}$  | 3.13       | °C/W |
| – Junction to Ambient  | $\theta_{JA}$  | 100        |      |
| Maximum Lead Temperature for Soldering Purposes, 1/8" from case for 10 seconds   | $T_L$          | 260        | °C   |

## ELECTRICAL CHARACTERISTICS

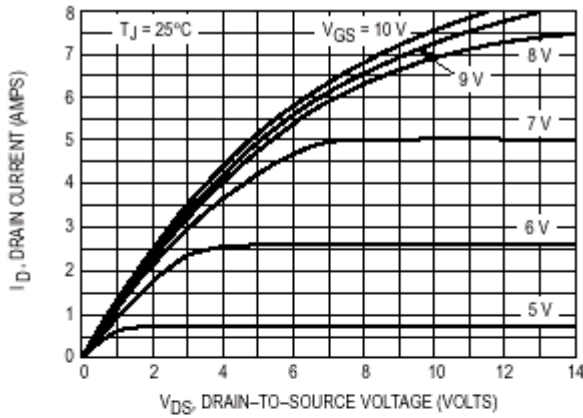
Unless otherwise specified,  $T_J = 25^\circ\text{C}$ .

| Characteristic   | Symbol   | Min          | Typ  | Max       | Units         |
|--|--|--------------|------|-----------|---------------|
| Drain-Source Breakdown Voltage<br>( $V_{GS} = 0\text{ V}$ , $I_D = 250\ \mu\text{A}$ )   | $V_{(BR)DSS}$  | 200          |      |           | V             |
| Drain-Source Leakage Current<br>( $V_{DS} = 200\text{ V}$ , $V_{GS} = 0\text{ V}$ )<br>( $V_{DS} = 200\text{ V}$ , $V_{GS} = 0\text{ V}$ , $T_J = 125^\circ\text{C}$ ) | $I_{DSS}$  |              |      | 10<br>100 | $\mu\text{A}$ |
| Gate-Source Leakage Current-Forward<br>( $V_{gsf} = 20\text{ V}$ , $V_{DS} = 0\text{ V}$ )   | $I_{GSSF}$   |              |      | 100       | nA            |
| Gate-Source Leakage Current-Reverse<br>( $V_{gsr} = 20\text{ V}$ , $V_{DS} = 0\text{ V}$ )   | $I_{GSSR}$   |              |      | 100       | nA            |
| Gate Threshold Voltage<br>( $V_{DS} = V_{GS}$ , $I_D = 250\ \mu\text{A}$ )   | $V_{GS(th)}$   | 2.0          | 3.0  | 4.0       | V             |
| Static Drain-Source On-Resistance ( $V_{GS} = 10\text{ V}$ , $I_D = 2.0\text{A}$ ) *   | $R_{DS(on)}$   |              | 0.98 | 1.2       | $\Omega$      |
| Drain-Source On-Voltage ( $V_{GS} = 10\text{ V}$ )<br>( $I_D = 4.0\text{ A}$ )   | $V_{DS(on)}$   |              | 3.5  | 5.8       | V             |
| Forward Transconductance ( $V_{DS} = 15\text{ V}$ , $I_D = 2.0\text{A}$ ) *  | $g_{FS}$   | 1.5          | 2.1  |           | S             |
| Input Capacitance  | $(V_{DS} = 25\text{ V}$ , $V_{GS} = 0\text{ V}$ ,<br>$f = 1.0\text{ MHz}$ )                            | $C_{ISS}$    | 311  | 430       | pF            |
| Output Capacitance   |  | $C_{OSS}$    | 66   | 80        | pF            |
| Reverse Transfer Capacitance   |  | $C_{RSS}$    | 11   | 20        | pF            |
| Turn-On Delay Time   | $(V_{DD} = 100\text{ V}$ , $I_D = 4.0\text{ A}$ ,<br>$V_{GS} = 10\text{ V}$ ,<br>$R_G = 9.1\Omega$ ) * | $t_{d(on)}$  | 10   | 17        | ns            |
| Rise Time  |  | $t_r$        | 4.0  | 26        | ns            |
| Turn-Off Delay Time  |  | $t_{d(off)}$ | 15   | 29        | ns            |
| Fall Time  |  | $t_f$        | 6.0  | 18        | ns            |
| Total Gate Charge  | $(V_{DS} = 160\text{ V}$ , $I_D = 4.0\text{ A}$ ,<br>$V_{GS} = 10\text{ V}$ ) *                        | $Q_g$        | 9.2  | 14        | nC            |
| Gate-Source Charge   |  | $Q_{gs}$     | 2.4  |           | nC            |
| Gate-Drain Charge  |  | $Q_{gd}$     | 4.1  |           | nC            |
| Internal Drain Inductance<br>(Measured from the drain lead 0.25" from package to center of die)  | $L_D$  |              | 4.5  |           | nH            |
| Internal Drain Inductance<br>(Measured from the source lead 0.25" from package to source bond pad)   | $L_S$  |              | 7.5  |           | nH            |
| <b>SOURCE-DRAIN DIODE CHARACTERISTICS</b>  |  |              |      |           |               |
| Forward On-Voltage(1)  | $(I_S = 4.0\text{ A}$ , $V_{GS} = 0\text{ V}$ ,<br>$d_i/d_t = 100\text{A}/\mu\text{s}$ )               | $V_{SD}$     |      | 0.92      | V             |
| Forward Turn-On Time   |  | $t_{on}$     |      | **        | ns            |
| Reverse Recovery Time  |  | $t_{rr}$     |      | 123       | ns            |

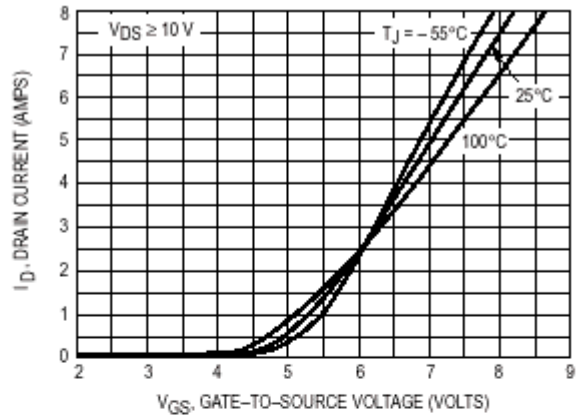
\* Pulse Test: Pulse Width  $\leq 300\mu\text{s}$ , Duty Cycle  $\leq 2\%$

\*\* Negligible, Dominated by circuit inductance

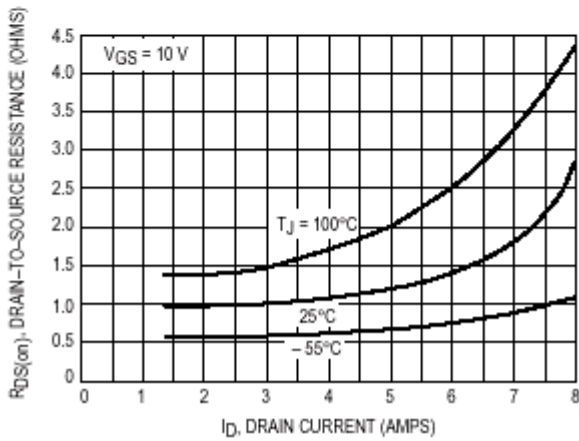
**TYPICAL ELECTRICAL CHARACTERISTICS**



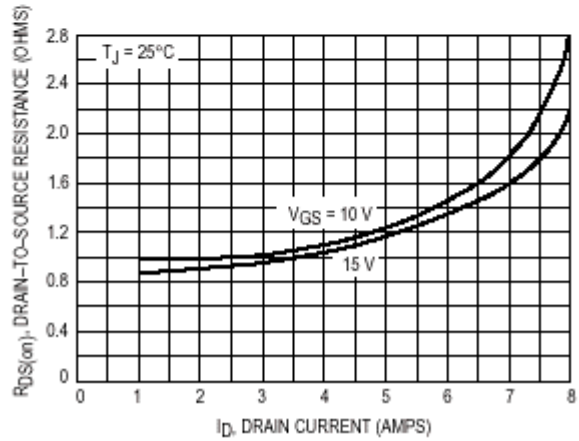
**Figure 1. On-Region Characteristics**



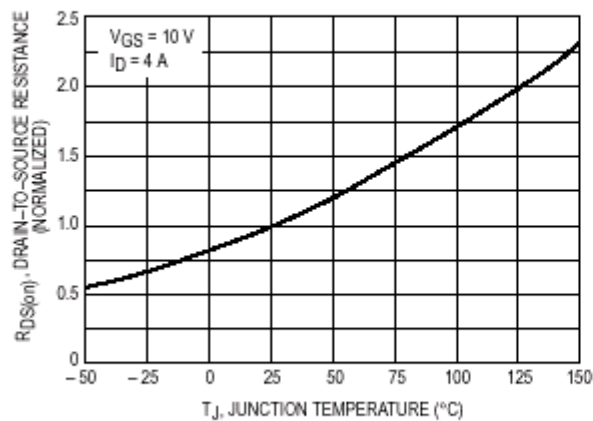
**Figure 2. Transfer Characteristics**



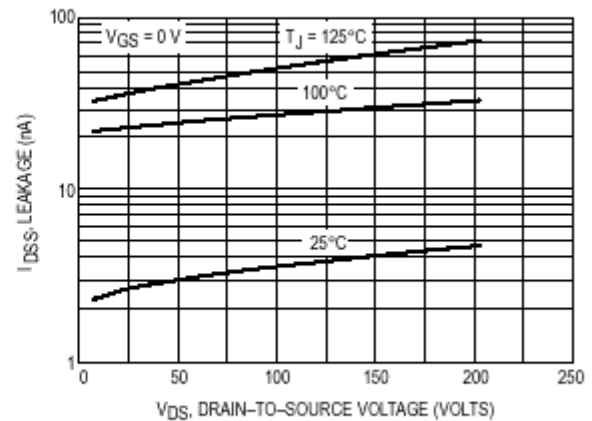
**Figure 3. On-Resistance versus Drain Current and Temperature**



**Figure 4. On-Resistance versus Drain Current and Gate Voltage**

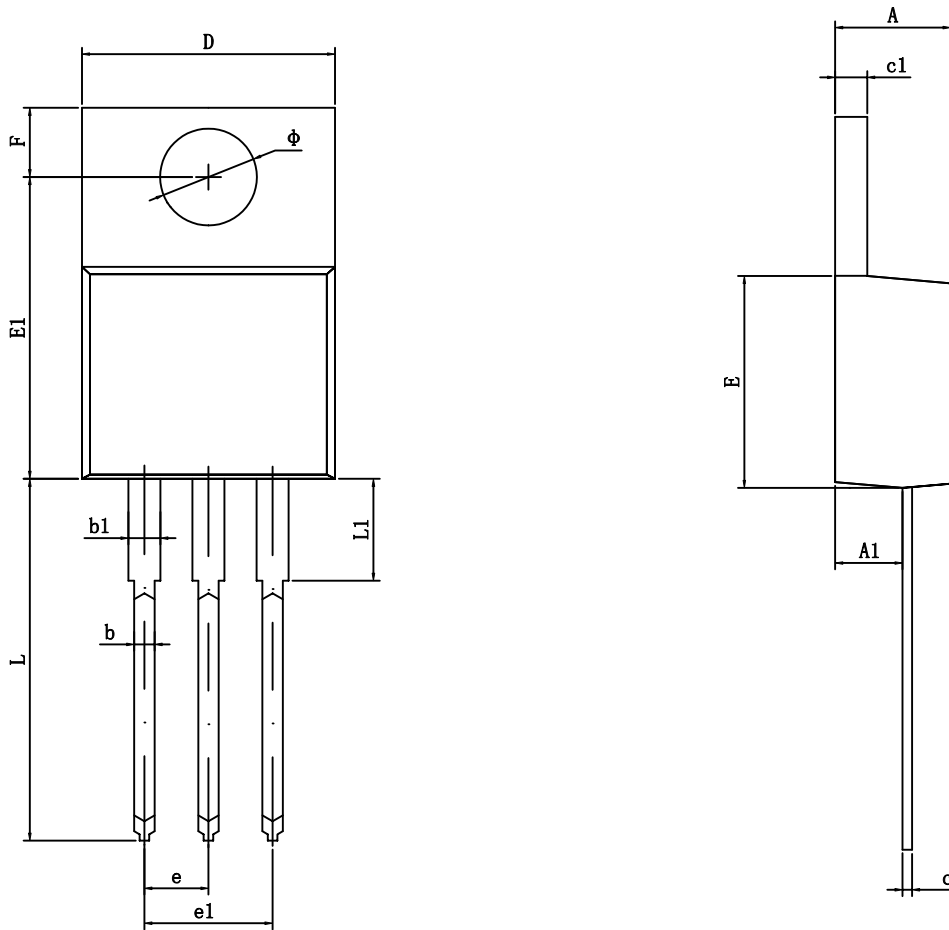


**Figure 5. On-Resistance Variation with Temperature**



**Figure 6. Drain-to-Source Leakage Current versus Voltage**

**TO-220 PACKAGE OUTLINE DIMENSIONS**



| Symbol | Dimensions In Millimeters |        | Dimensions In Inches |       |
|--------|---------------------------|--------|----------------------|-------|
|        | Min                       | Max    | Min                  | Max   |
| A      | 4.470                     | 4.670  | 0.176                | 0.184 |
| A1     | 2.520                     | 2.820  | 0.099                | 0.111 |
| b      | 0.710                     | 0.910  | 0.028                | 0.036 |
| b1     | 1.170                     | 1.370  | 0.046                | 0.054 |
| c      | 0.310                     | 0.530  | 0.012                | 0.021 |
| c1     | 1.170                     | 1.370  | 0.046                | 0.054 |
| D      | 10.010                    | 10.310 | 0.394                | 0.406 |
| E      | 8.500                     | 8.900  | 0.335                | 0.350 |
| E1     | 12.060                    | 12.460 | 0.475                | 0.491 |
| e      | 2.540TYP                  |        | 0.100TYP             |       |
| e1     | 4.980                     | 5.180  | 0.196                | 0.204 |
| F      | 2.590                     | 2.890  | 0.102                | 0.114 |
| L      | 13.400                    | 13.800 | 0.528                | 0.543 |
| L1     | 3.560                     | 3.960  | 0.140                | 0.156 |
| φ      | 3.790                     | 3.890  | 0.149                | 0.153 |