

DPM 500-BL

3½ Digit Backlit LCD Module

The DPM 500-BL uses advanced components and construction techniques to provide a uniquely compact unit. The meter is in a 40 pin DIL integrated circuit format that can be plugged directly into a DIL socket or panel mounted using the snap in bezel.

- 🌀 12.5mm (0.5") Digit Height
- 🌀 Programmable Decimal Points
- 🌀 Auto-zero
- 🌀 Auto-polarity
- 🌀 200mV d.c. Full Scale Reading (F.S.R.)
- 🌀 LED Backlit
- 🌀 Annunciators



SCALING

Two resistors Ra and Rb may be fitted in order to alter the full scale reading (F.S.R.) of the meter - see table. Meter will need re-calibration.

Required F.S.R.		Ra	Rb
2V	Note	910k	100k
20V	Note	1M	10k
200V	Note	1M	1k
2kV	Note	1M	100R
200μA		0R	1k
2mA		0R	100R
20mA		0R	10R
200mA		0R	1R

NOTE
Ensure link 10 is cut if fitting Ra.

SAFETY

To comply with the Low Voltage Directive (LVD 93/68/EEC), input voltages to the module's pins must not exceed 60Vdc. If voltages to the measuring inputs do exceed 60Vdc, then fit scaling resistors externally to the module. The user must ensure that the incorporation of the DPM into the user's equipment conforms to the relevant sections of BS EN 61010 (Safety Requirements for Electrical Equipment for Measuring, Control and Laboratory Use).

Backlit Version	Stock Number DPM 500-BL			
Specification	Min.	Typ.	Max.	Unit
Accuracy (overall error)*		0.05	0.1	% (±1 count)
Linearity			±1	count
Sample rate		3		sample/sec
Operating temperature range	0		50	°C
Temperature stability		100		ppm/°C
Supply voltage	7.5	9	14	V
Supply current		150		μA
Backlight voltage		5		V
Backlight current		30	60	mA
Input leakage current (Vin = 0V)		1	10	pA

* To ensure maximum accuracy, re-calibrate periodically.

CONNECTOR SOURCING GUIDE

METHOD	40 Pin DIL IC Socket
--------	----------------------

DIMENSIONS All dimensions in mm (inches)

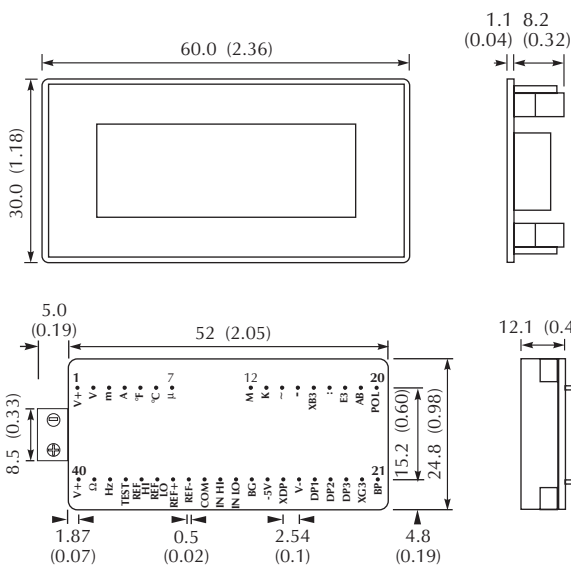

PANEL FITTING

Fit the bezel to the front of the panel and locate the meter into the bezel from behind. Alternatively the meter and bezel may be assembled before fitting to the front of the panel but care must be taken not to use excessive force. Finally fit the window into the front of the bezel.

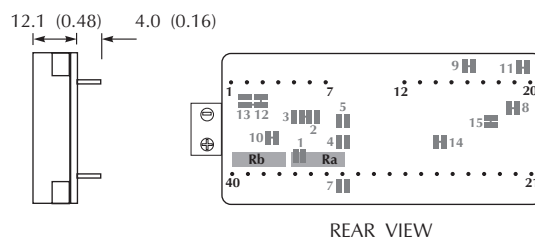
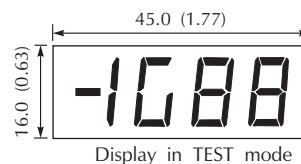

- ON-BOARD LINKS
- OPTIONAL SCALING RESISTORS

PIN FUNCTIONS

- 1, 40. V+ Positive power supply.
- 2-7, 12-14, 17, 38, 39 See **SPECIAL NOTE: ANNUNCIATORS.**
- 15. - Input for the polarity annunciator. Internally linked to POL (pin 20). If this is to be externally controlled, cut link 11.
- 16, 18, 19, 22 XB3, E3, AB, XG3. Outputs for use in auto-ranging applications.
- 20. POL Drive for "-" annunciator. Internally connected by link 11.
- 21. BP LCD backplane drive waveform.
- 23. DP3 1.999
- 24. DP2 19.99
- 25. DP1 199.9
- 26. V- Negative power supply.
- 27. XDP Connect to required annunciators/DPs (see note).
- 28. -5V Not connected.
- 29. BG Input for bandgap reference. (1.22V nom).
- 30. IN LO Negative measuring input. } Analogue inputs must be no closer than 1V to either the positive or negative supply.
- 31. IN HI Positive measuring input. } Analogue inputs must be no closer than 1V to either the positive or negative supply.
- 32. COM The ground for the analogue section of the A/D converter, held actively at 2.8V (nom) below V+. COM must not be allowed to sink excessive current (> 100µA) by connecting it directly to a higher voltage.
- 33. REF- Negative output from internal reference.
- 34. REF+ Positive output from internal reference.
- 35. REF LO Negative input for reference voltage.
- 36. REF HI Positive input for reference voltage.
- 37. TEST Connecting this pin to V+ turns on the segments as illustrated. It should not be operated for more than a few seconds as the DC voltage applied to the LCD may "burn" the display. This pin is nominally at 5V below V+ and is the ground for the digital section of the meter, it can be used as a negative supply to power external logic up to a maximum of 1mA.
- 40. V+/CLK Normally tied to V+ via Link 12 but can be used to over ride the internal oscillator and control the sample rate by cutting Link 12 and making Link 13.

LED BACKLIT VERSIONS: Apply 5V DC to the backlight tab on the side of the meter. Typical current is 30mA. For higher voltages, fit a resistor in series. E.g. For 9V use 150R. Maximum current = 60mA.

ANNUNCIATORS: The DPM annunciators (DPs, °C, etc.) can be displayed by connecting them to XDP. However as these annunciators are normally 'floating', under certain conditions they may appear when not wanted. To suppress unwanted annunciators, link them to the backplane (BP). If the annunciators are being switched, connect them via a 1M resistor to the BP (pin 21). The annunciators will then operate normally when connected to XDP. Ensure that an annunciator is not connected directly to the XDP and BP at the same time.

VARIOUS OPERATING MODES

ON-BOARD LINKS: In order to quickly and easily change operating modes for different applications, the meter has several "on-board links". They are designed to be easily opened (cut) or shorted (soldered). Do not connect more than one meter to the same power supply if the meters cannot use the same signal ground. Taking any input beyond the power supply rails will damage the meter.

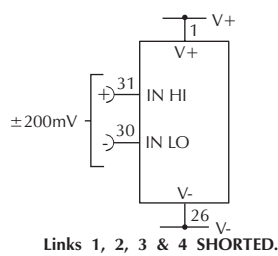

Measuring a floating voltage source of 200mV full scale.

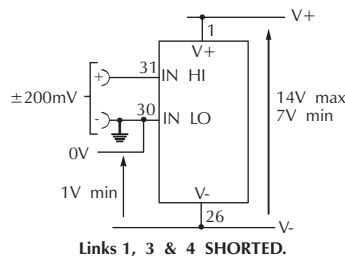

Split supply operation.

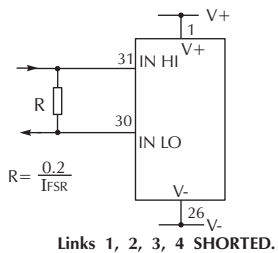

Measuring current (supply MUST be isolated).

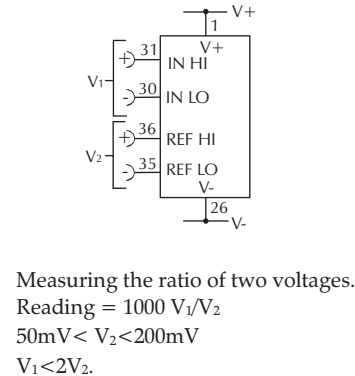

Measuring the ratio of two voltages.
 Reading = 1000 V₁/V₂
 50mV < V₂ < 200mV
 V₁ < 2V₂.

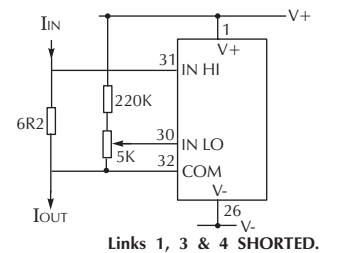

Measuring 4-20mA to read 0-999 (supply must be isolated).