



Title	<i>Engineering Prototype Report for EP-31 Multiple Output 180 W AC-DC Power Supply using TOP249Y (TOPSwitch®-GX) and TNY266P (TinySwitch®-II) and</i>
Specification	110 VAC Doubled or 230 VAC Input, +5 V, +3.3 V, +12 V, -12 V & +5 V Stdby Outputs
Application	ATX 12 V PC Main Supply with Passive PFC in a Micro-ATX Enclosure
Author	Power Integrations Application Department
Document Number	EPR-31
Date	01-Feb-05
Revision	1.1

Summary and Features

- Highly integrated IC realizes a significant reduction in component count
- Main transformer resets with a 700 V MOSFET and no reset winding
- Input power < 1 W (with standby loaded to 0.5 W and the main supply off)
- Meets Blue Angel 5 W requirement (measures 4.1 W, at specified conditions)
- Passes EN55022 B conducted EMI limits, with more than 10 dB of margin
- Simple voltage mode control provides good transient response & regulation

The products and applications illustrated herein (including circuits external to the products and transformer construction) may be covered by one or more U.S. and foreign patents or potentially by pending U.S. and foreign patent applications assigned to Power Integrations. A complete list of Power Integrations' patents may be found at www.powerint.com.

Table Of Contents

1	Introduction.....	3
2	Power Supply Specification	4
3	Schematic.....	5
4	Circuit Description	8
5	PCB Layout	10
5.1	Assembly Diagram	10
5.2	Top View	12
6	Bill Of Materials	14
6.1	Main Board Bill of Materials.....	14
6.2	Control Board Bill of Materials.....	16
7	Transformer Specification.....	17
7.1	180 W Forward Transformer	17
7.1.1	Electrical Diagram	17
7.1.2	Electrical Specifications.....	17
7.1.3	Materials.....	17
7.1.4	Transformer Build Diagram	18
7.1.5	Transformer Construction.....	18
7.2	10 W PC Standby Transformer	20
7.2.1	Electrical Diagram	20
7.2.2	Electrical Specifications.....	20
7.2.3	Materials.....	20
7.2.4	Transformer Build Diagram	21
7.2.5	Transformer Construction.....	21
7.3	Output Coupled Inductor	22
7.3.1	Toroid Layout	22
7.3.2	Electrical Diagram	22
7.3.3	Inductances.....	22
7.4	Mag Amp Inductor	23
7.4.1	Core Specifications	23
7.4.2	Winding Instructions.....	23
8	Transformer Spreadsheets.....	24
9	Performance Data	27
9.1	Efficiency and Regulation.....	27
10	Thermal Performance	28
11	Waveforms.....	29
12	Output Ripple Measurements	31
12.1	Ripple Measurement Technique.....	31
12.2	Measurement Results	32
13	Conducted EMI	33
14	Revision History	34

Important Note:

Although this circuit board has been designed to meet safety isolation requirements, the engineering prototype has not been agency approved. Therefore, all testing should be performed using an isolation transformer to provide the AC input to the prototype board.



1 Introduction

This engineering report describes the operation and provides performance data for a 180 W forward converter-based PC mains supply (using *TOPSwitch-GX*), and a 10 W flyback converter-based PC standby supply (using *TinySwitch-II*).

This design is intended to demonstrate the viability of the *TOPSwitch-GX* in a PC main application, in a micro-ATX enclosure, with passive PFC. Because many of the functions necessary for a forward converter are integrated into the *TOPSwitch-GX* family of power conversion ICs, designing around it reduces the PCB area required for the layout of the main converter.

A supervisory ASIC was not included. However, a simple circuit (see Figure 5) was implemented to demonstrate the remote ON/OFF and fault latching operation that an ASIC normally performs. The 3.3 V output does not have remote voltage sensing, but using standard techniques this could easily be added.

This report contains power supply specifications, bills of material (BOM), circuit diagrams, custom magnetic components documentation (transformers, output inductor and mag-amp inductor), PCB layouts, and pertinent electrical test data.



Figure 1 – Photograph of the populated circuit boards of the EP-31 prototype.

2 Power Supply Specification

Description	Symbol	Min	Typ	Max	Units	Comment
Input						
Voltage	V_{IN}	90		265	VAC	3-Wire (with Protective Earth)
Frequency	f_{LINE}	47	50/60	63	Hz	
Blue Angel				4.75	W	With standby output loaded to 2.5 watts
Standby Input Power (230 VAC)				0.95	W	With standby output loaded to 0.5 watts
Output						
Output Voltage 1	V_{OUT1}	4.75	5.00	5.25	V	$\pm 5\%$
Output Ripple Voltage 1	$V_{RIPPLE1}$			50	mV	20 MHz Bandwidth
Output Current 1	I_{OUT1}	1.0		12.0	A	
Output Voltage 2	V_{OUT2}	3.14	3.3	3.45	V	$\pm 5\%$
Output Ripple Voltage 2	$V_{RIPPLE2}$			50	mV	20 MHz Bandwidth
Output Current 2	I_{OUT2}	2.0		10.0	A	
Output Voltage 3	V_{OUT3}	11.4	12.0	12.6	V	$\pm 5\%$
Output Ripple Voltage 3	$V_{RIPPLE3}$			120	mV	20 MHz Bandwidth
Output Current 3	I_{OUT3}	2.0	10.0	13.0	A	
Output Voltage 4	V_{OUT4}	-11.4	-12.0	-12.6	V	$\pm 5\%$
Output Ripple Voltage 4	$V_{RIPPLE4}$			120	mV	20 MHz Bandwidth
Output Current 4	I_{OUT4}			1.5	A	
Output Voltage 5 (Standby)	V_{OUT5}	4.75	5.0	5.25	V	$\pm 5\%$
Output Ripple Voltage 5	$V_{RIPPLE5}$			50	mV	20 MHz Bandwidth
Output Current 5	I_{OUT5}	0		2.0	A	
Total Output Power						
Continuous Output Power	P_{OUT}			180	W	
Peak Output Power	P_{OUT_PEAK}			200	W	
Efficiency	η	68	72	75	%	Measured at P_{OUT} (43 W), 25 °C
Environmental						
Conducted EMI						Meets CISPR22B / EN55022B
Safety						Designed to meet IEC950, UL1950 Class II
Surge		3			kV	1.2/50 μ s surge, IEC 1000-4-5, Series Impedance: Differential Mode: 2 Ω Common Mode: 12 Ω
Surge		3			kV	100 kHz ring wave, 500 A short circuit current, differential and common mode
Ambient Temperature	T_{AMB}			50	°C	Free convection, sea level



3 Schematic

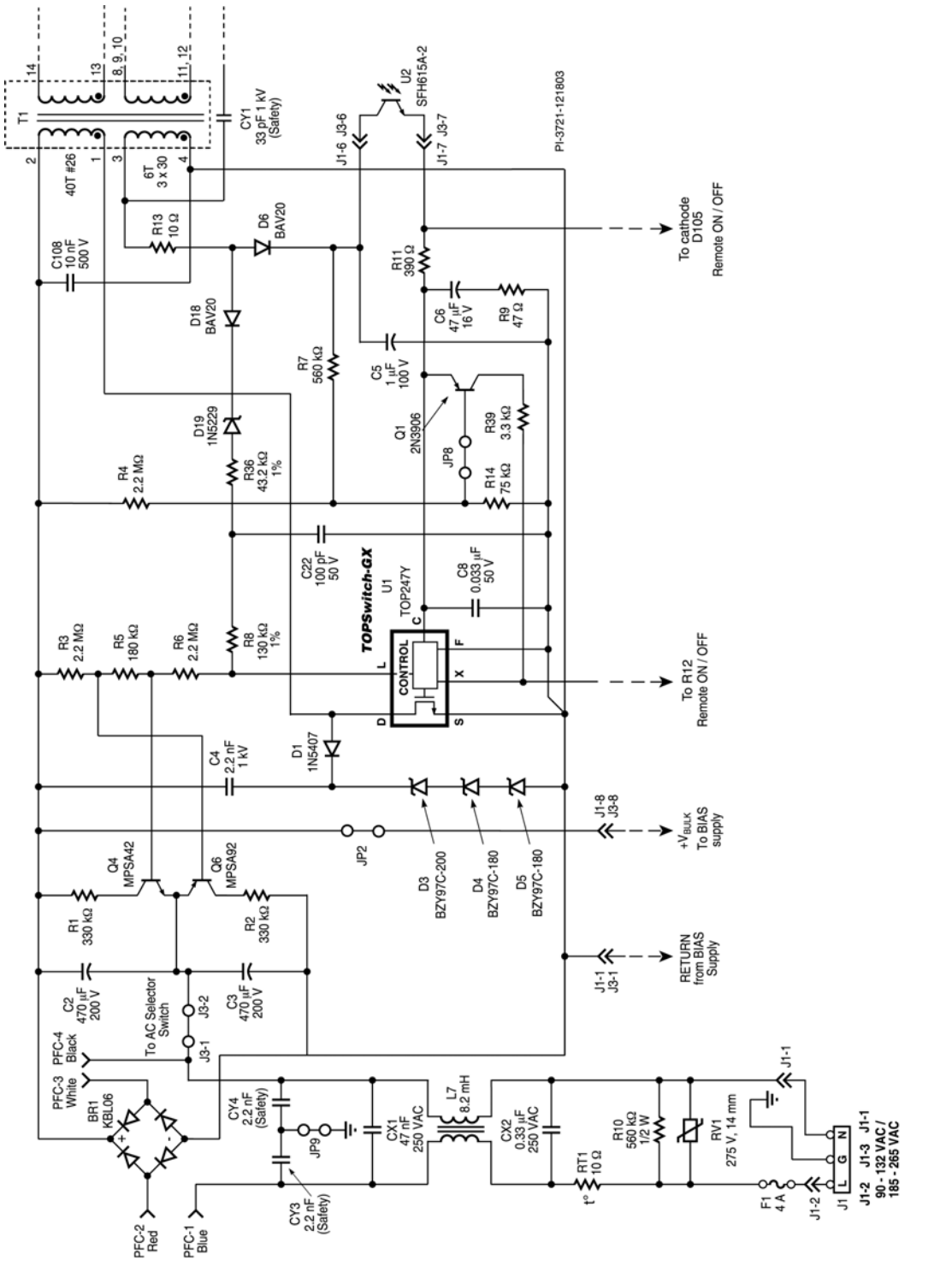

Figure 2 – EP-31 Main Forward Converter, Primary Side.



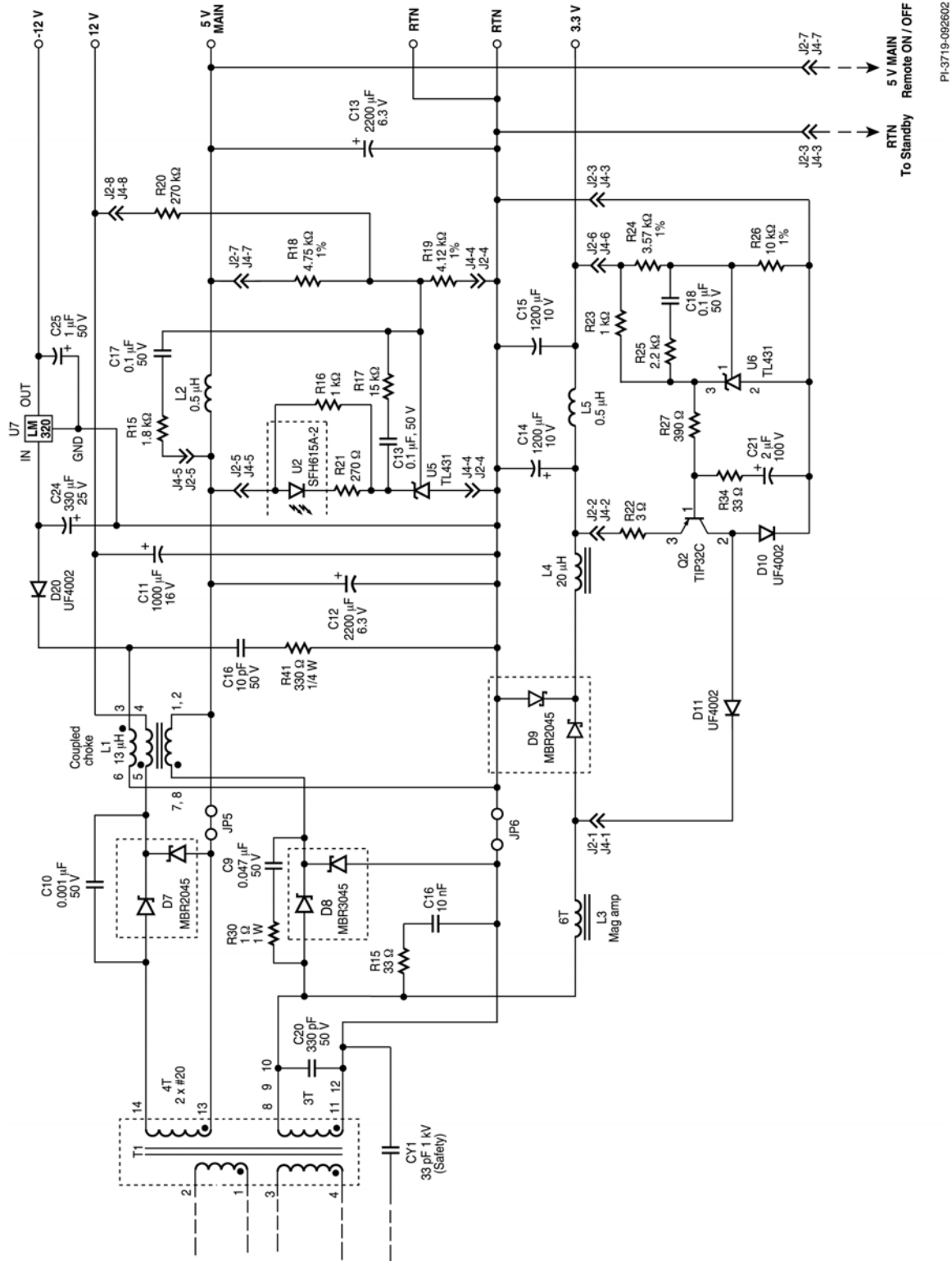

Figure 3 – EP-31 Main Forward Converter, Secondary Side.



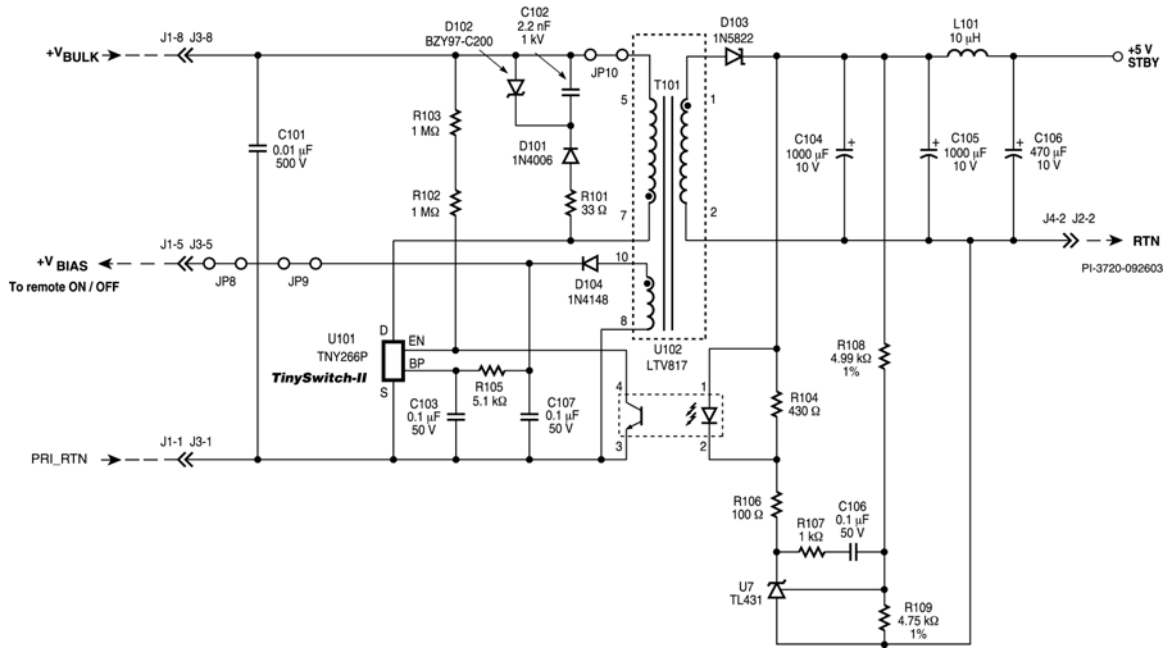

Figure 4 – EP-31 Standby Flyback Converter.

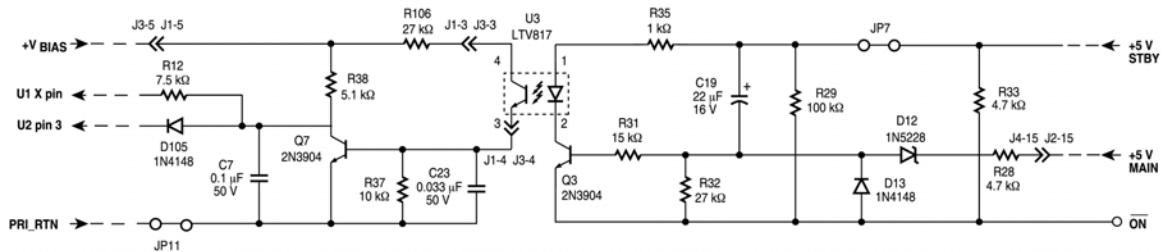

Figure 5 – EP-31 Remote ON / OFF Interface.



4 Circuit Description

With line feed-forward, duty factor reduction, a programmable primary current limit, line sense for input under-voltage (UV) lockout and overvoltage (OV) shutdown and a soft-start function for reduced stresses during start-up, all integrated onto one monolithic IC, the *TOPSwitch-GX* family has all of the functions necessary to operate as an off-line, single-ended forward converter. Also, the *TOPSwitch-GX* family has sufficient power capability to address the PC main application arena.

In this design, the Line sense (**L**) pin (see the *TOPSwitch-GX* data sheet for a description of the **L** pin functions and uses) senses the rectified AC input voltage through R3, R5, and R6, and inhibits the start of U1 switching until the minimum input voltage [80 VAC (110 VAC Nom. line), 160 VAC (230 VAC Nom. line)] is reached. When U1 begins switching, bias winding (T1, pin 3) current, delivered through R13, D18, D19, R36 and R8, immediately sets a maximum duty factor limit by injecting current into the **L** pin (see the *TOPSwitch-GX* data sheet for a description of maximum duty cycle DC_{MAX} reduction operation). The **L** pin sums current from two sources: directly from the line (R3, R5 & R6) and from the bias winding (T1 pins 3–4, R13, D18, D19, R36, C22 and R8). The rectified forward pulse from the bias winding develops a DC voltage across C22, which determines the current that flows through R8 into the **L** pin. The **L** pin current increases with line voltage and reduces the DC_{MAX} , preventing the possibility of transformer saturation during line or load transients.

A TOP249Y device was selected for this application. Its primary current limit has been programmed to about 3.5 A (via the **X** pin), by pull-down resistor R12, which is connected (through Q7) to primary return (the SOURCE pin of U1) when the supply is on (the U3 phototransistor is on and Q7 is saturated.). This limits the peak output power that the load(s) can demand from this design to about 200 W.

When the AC input voltage drops below 75 V, a second UV lockout circuit (R4, R14, R39 and Q1) activates preventing shutdown glitches. Transistor Q1 is biased on when V_{IN} drops below 75 VAC. Its collector then pulls up the U1 **X** pin (through R39), disabling its MOSFET from switching (see the *TOPSwitch-GX* data sheet, Figure 11, for how the **X** pin can be used to enable/disable output MOSFET switching).

The Zener clamp portion (D3, D4, and D5) of the primary snubber circuit only conducts lightly during normal steady-state operation. Capacitor C4 is coupled to the node of T1 and the DRAIN of U1 through a slow recovery diode (D1). This very efficient snubber allows the highest possible flyback voltage to develop during the U1-MOSFET off time, and recycles a significant amount of that energy back through T1 (to C9 and the output) during the reverse recovery time of D1.



The dissipation in the entire circuit (D1, C4, and D3–D5) measures only about 1.5 W at maximum load.

TOPSwitch-GX uses voltage mode control to regulate the main output voltage. Output transient load-step waveforms show very good responsiveness (optimal performance) and the control loop gain and phase margin plots show that the control loop is stable with adequate margin.

This design uses a very simple remote ON/OFF circuit (see Figure 5). When the **ON** line (the green wire in the output cable) is momentarily connected to the output return (grounded), Q3 turns on, pulling current through the U3-LED, which turns on Q7, which pulls down R12, enabling U1 to start switching. When the output comes up into regulation before C19 discharges, Q3 is kept on through R28, and U1 keeps switching. IC U1 stops switching if output regulation is lost. Then the **ON** line must be toggled (ungrounded and then re-grounded) to restart the supply.

When the **ON** line is ungrounded, it is internally pulled up (by R33) to the +5 V standby and U1 remains disabled. The +5 V standby is always operating above a DC rail voltage of 100 VDC. Grounding the **ON** line will turn the main supply on, if the AC line voltage is above the UV threshold and there is not a fault condition. If a fault condition exists, U1 will stay in its auto-restart mode until C19 discharges. The **ON** line must be toggled again to attempt another restart.

***Note 1:** If the remote **ON** line is grounded (main power enabled) when AC is first applied to the supply, the main converter will automatically turn on. However, if AC is brought up too slowly (i.e. adjusting a variac), the supply will not turn on and the **ON** line will have to be toggled to turn on the supply. **On the output interconnect board that is provided with the DAK Kit, the ON line is already connected to an ON/OFF switch, enabling the supply to be turned ON and OFF.**



5 PCB Layout

5.1 Assembly Diagram

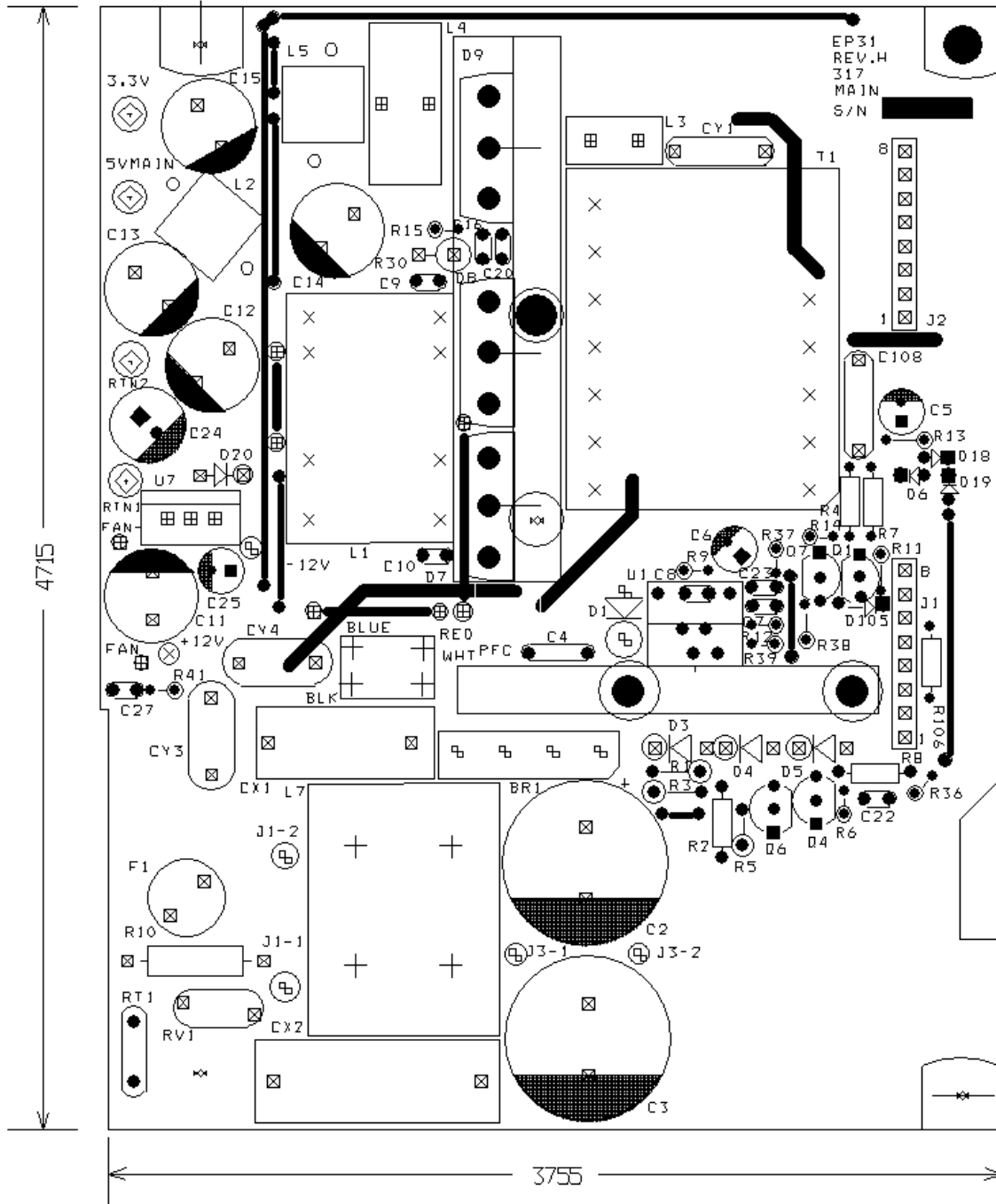

Figure 6 – Main Board PCB Silk Screen Artwork (shows component locations).



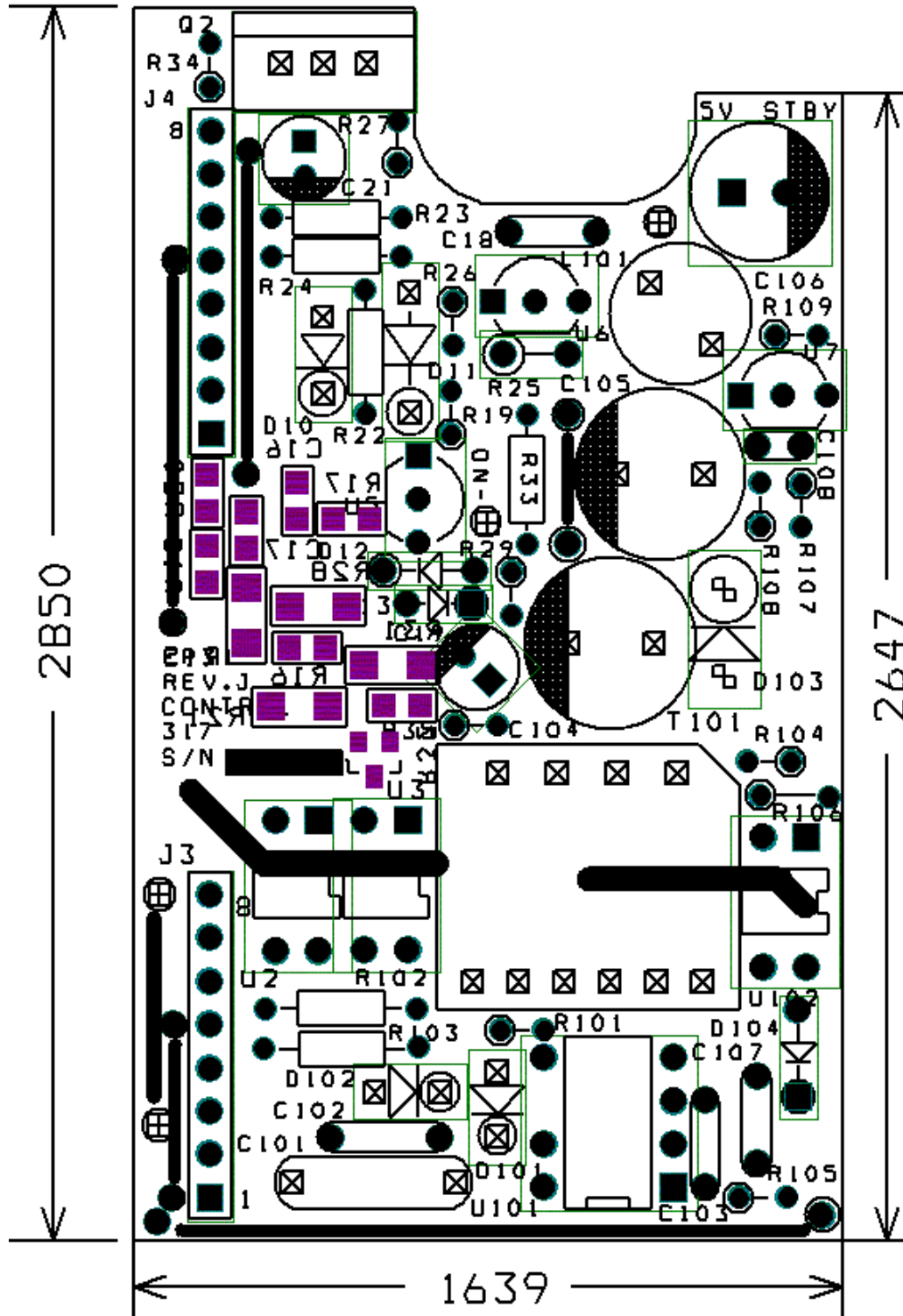

Figure 7 – Control Board PCB Silk Screen Artwork (shows component locations).



5.2 Top View

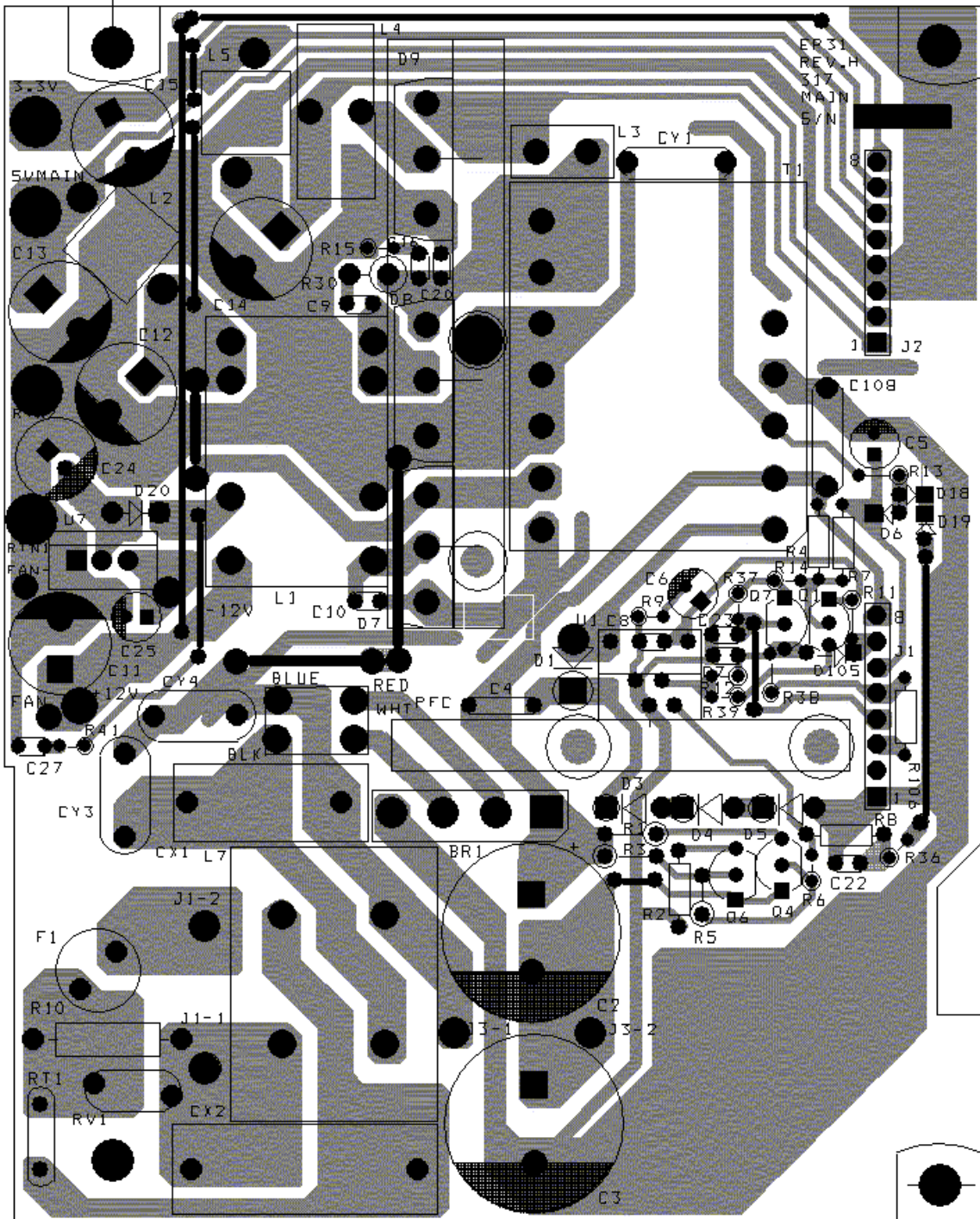

Figure 8 – Main Board PCB Layout Artwork.

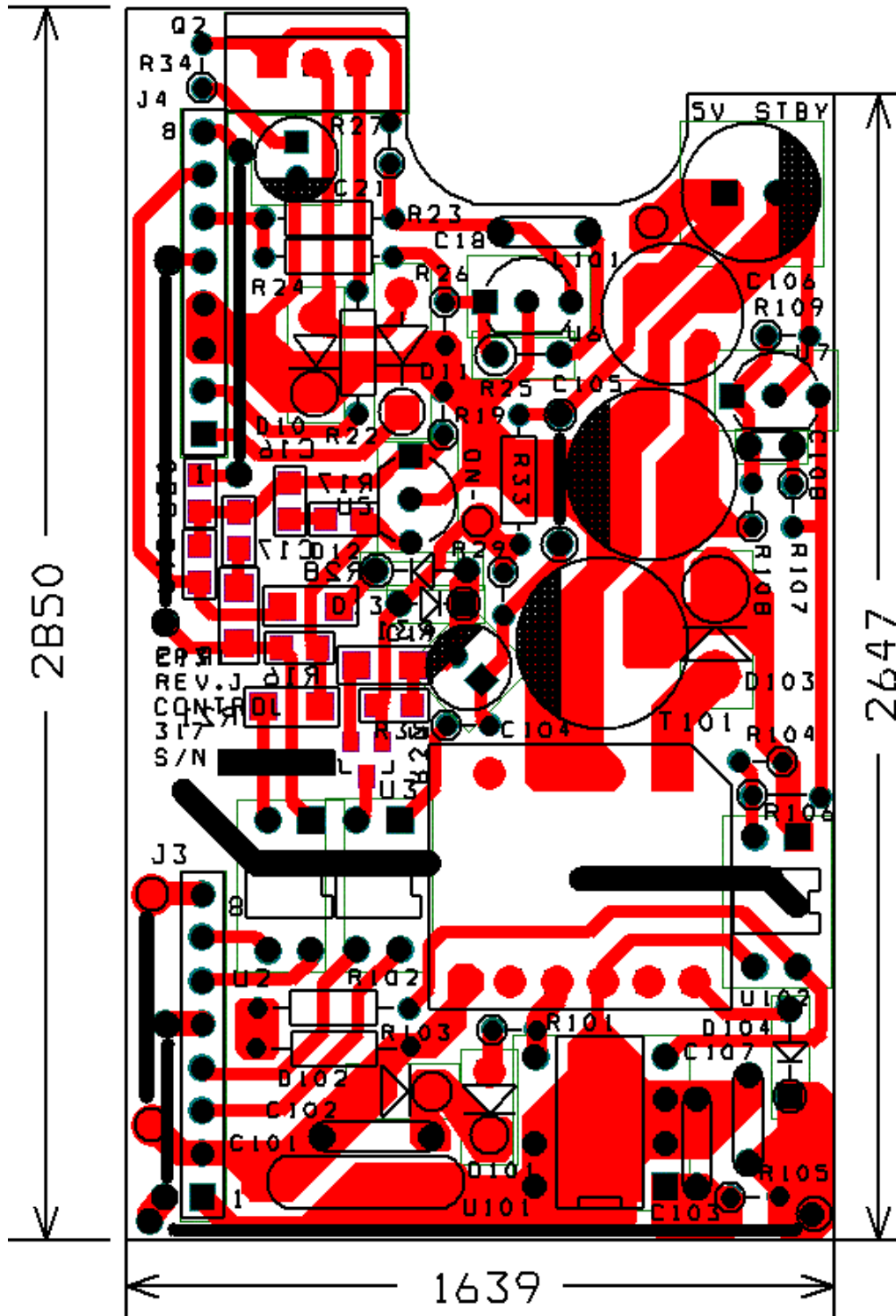

Figure 9 – Control Board PCB Layout Artwork.



6 Bill Of Materials

6.1 Main Board Bill of Materials

Item	Qty	Reference	Description	P/N	Manufacturer
1	1	BR1	600 V, 4 A Bridge Rectifier	KBL06	General Semiconductor
2	1	CX1	47 nF, 250 VAC X type Cap	ECQ-U2A473MV	Panasonic
3	1	CX2	0.33 μ F, 250 VAC X type Cap	ECQ-U2A334MG	Panasonic
4	1	CY1	33 pF, 1 kV Y type Safety Cap	440LQ33	Vishay/Sprague
5	2	CY4, CY3	2.2 nF, 1 kV Y type Safety Cap	ECK-ATS222ME	Vishay/Sprague
6	2	C3, C2	470 μ F, 200 V Electrolytic Cap		CapXon
7	2	C4	2.2 nF, 1 kV		Xicon
8	2	C5, C25	1 μ F, 100 V	ECA-2AHG010	Panasonic
9	2	C6	47 μ F, 16 V	ECA-1CHG470	Panasonic
10	1	C7	0.1 μ F, 50 V	ECU-S1H104MEA	Panasonic
11	2	C8, C23	33 nF, 50 V	ECU-S2A333KBA	Panasonic
12	1	C9	47 nF, 50 V	K473K15X7RF5TL2	BC Components
13	1	C10	1 nF, 50 V	ECU-S1H102JCB	Panasonic
14	1	C11	1000 μ F, 16 V	EEU-FC1C102	Panasonic
15	2	C13, C12	2200 μ F, 6.3 V	EEU-FC0J222	Panasonic
16	2	C14, C15	1200 μ F, 10 V	ECA-FC1A122	Panasonic
17	2	C20, 27	330 pF, 50 V	ECU-S1H331JCA	Panasonic
18	1	C22	100 pF, 50 V	ECU-S1H101JCA	Panasonic
19	1	C24	330 μ F, 25 V	EEU-FC1C331L	Panasonic
20	1	C16	10 nF, 50 V	ECU-S1H103KBA	Panasonic
21	1	C108	10 nF, 500 V	140-500P9-103K	Xicon
22	1	D1	800 V, 3 A diode	1N5407-T	Any
23	1	D3	200 V, 1.5 W Zener diode	BZY97C-200	Vishay
24	2	D4, D5	180 V, 1.5 W Zener diode	BZY97C-180	Vishay
25	2	D6, D18	150 V, 625 mA, Gen Purpose	BAV20	Diodes Inc.
26	1	D19	3.9 V, 0.5 W Zener diode	1N5229	Vishay
27	1	D8	45 V, 60 A Schottky diode	MBR6045WT	International Rectifier
28	2	D7, D9	45 V, 30 A Schottky diode	MBR3045WT	International Rectifier
29	1	D20	1 A, Ultra Fast recovery diode	UF4002	Vishay
30	1	D105	100 V, 300 mA Fast diode	1N4148-T	Diodes Inc.
31	1	F1	4 A Slow Blow Fuse	3721400041	Wickmann
32	1	L1	13 μ H, 15 A Coupled Choke	SIL6015	HICAL
33	2	L5, L2	0.9 μ H	SPE-119-0	Premier Magnetics
34	1	L3	Mag amp	SIL6014	DT Magnetics
35	1	L4	25 μ H	5702	J.W. Miller
36	1	L7	3.3 mH	ELF-18D650B	Panasonic
37	1	Q1	TO-92 Transistor / PNP	2N3906	Any
38	1	Q7	TO-92 Transistor / NPN	2N3904	Any
39	1	Q4	TO-92 transistor / NPN 300 V	MPSA42	Any
40	1	Q6	TO-92 transistor / PNP 300 V	MPSA92	Any
41	1	RT1	10 Ω , 3.2 A Thermistor (Inrush)	RL3004-6.56-59-S7	Keystone
42	1	RV1	275 V, 14 mm dia. MOV	ERZ-V14D431	Panasonic
43	2	R1, R2	330 k Ω	CFR-25JB-330k	Yageo
44	3	R3, R4, R6	2.2 M Ω	CFR-25JB-2M2	Yageo
45	1	R7	560 k Ω	CFR-25JB-560K	Yageo
46	1	R5	180 k Ω	CFR-25JB-180K	Yageo
47	1	R8	130 k Ω , 1%	MFR-25FBF-130K	Yageo
48	1	R9	47 Ω	CFR-25JB-47R	Yageo
49	1	R10	560 k Ω , 1/2 W	CFR-50JB-560K	Yageo
50	1	R11	360 Ω	CFR-25JB-360R	Yageo
51	1	R39	3.3 k Ω	CFR-25JB-3K3	Yageo
52	1	R12	12 k Ω	CFR-25JB-12K	Yageo
53	1	R13	10 Ω	CFR-25JB-10R	Yageo
54	1	R14	75 k Ω	CFR-25JB-75K	Yageo



55	1	R30	1 Ω , 1 W	RSF100JB-1R0	Yageo
56	1	R36	43.2 k Ω , 1%	MFR-25FBF-43K2	Yageo
57	1	R37	10 k Ω	CFR-25JB-10K	Yageo
58	1	R38	5.1 k Ω	CFR-25JB-5K1	Yageo
59	1	R15	3.3 Ω	CFR-25JB-3K3	Yageo
60	1	R41	330 Ω	CFR-25JB-330R	Yageo
61	2	R106	27 k Ω	CFR-25JB-27K	Yageo
62	1	T1	Main X-former (ERL28 core)	SIL6013	HICAL
63	1	U7	-12 V regulator TO-220	LM320	Any
64	1	U1	Integrated Controller/MOSFET	TOP249Y	Power Integrations
65	1		Printed Circuit Board	PCB	



6.2 Control Board Bill of Materials

Item	Qty	Reference	Description	P/N	Manufacturer
1	1	C102	2.2 nF, 1000 V, Y5P, 10%		Xicon
2	1	C19	22 μ F, 16 V	ECA-A1CN220U	Panasonic
3	4	C18, C103, C107, C108	0.1 μ F, 50 V	ECU-S1H104MEA	Panasonic
4	2	C16, C17	0.1 μ F, 50 V	C0805C104M5RACTU	Kemet
5	1	C21	1.0 μ F, 50 V	ECA-2AHG2R2	Panasonic
6	1	C101	10 nF, 500 V, Y5P, 10%	ECA-A1CN220U	Xicon
7	2	C104, C105	1000 μ F, 10 V	EEU-FC1A102L	Panasonic
8	1	C106	470 μ F, 10 V	EEU-FC1A471	Panasonic
9	2	D11, D10	1 A, Ultra Fast recovery diode	UF4002	Fagor
10	1	D12	3.9 V, 0.5 W Zener diode	1N5228-D7	General Semiconductor
11	1	D103	40 V, 3 A Schottky diode	1N5822	General Semiconductor
12	2	D13, D104	100 V, 300 mA Fast diode	1N4148-T	Diodes Inc.
13	1	D101	800 V, 1 A Glass Passivated	1N4006-T	Diodes Inc.
14	1	D102	200 V, 1.5 W Zener diode	BZY97-C200	Philips
15	1	L101	10 μ H, 2 A Inductor	R622LY-100K	TOKO
16	1	Q2	100 V 3 A PNP, in a TO-220 pkg	TIP32C	
17	1	Q3	Gen purpose NPN, SOT 23 pkg	MMTB3904-7	
18	1	R15	1.8 k Ω (1206 pkg)		
19	1	R106	100 Ω	CFR-25JB-100R	
20	3	R23, R35, R107	1 k Ω	CFR-25JB-1K0	Yageo
21	1	R16	1 k Ω (0805 pkg)		
22	1	R17	15 k Ω (0805 pkg)		
23	1	R109	4.75 k Ω , 1%	CFR-25JB-4K75	Yageo
24	1	R108	4.99 k Ω , 1%	CFR-25JB-4K99	Yageo
25	1	R31	15 k Ω (1206 pkg)		
26	1	R18	4.75 k Ω , 1% (0805 pkg)		
27	1	R19	4.12 k Ω , 1%	CFR-25JB-4K12	Yageo
28	1	R20	270 k Ω (0805 pkg)		
29	1	R21	270 Ω (0805 pkg)		
30	1	R22	3 Ω	CFR-25JB-3R0	Yageo
31	1	R24	3.57 k Ω , 1%		Yageo
32	1	R25	2.2 k Ω	CFR-25JB-2K2	Yageo
33	1	R26	10 k Ω	CFR-25JB-10K	Yageo
34	1	R27	390 Ω	CFR-25JB-390R	Yageo
35	1	R28	4.7 k Ω (1206 pkg)		
36	1	R31	15 k Ω	CFR-25JB-10K	Yageo
37	1	R33	4.7 k Ω	CFR-25JB-4K7	Yageo
38	1	R29	100 k Ω	CFR-25JB-100K	Yageo
39	2	R34, R101	33 Ω	CFR-25JB-33R	Yageo
40	2	R103, R102	1 M Ω , 1%	CFR-25JB-4M0	Yageo
41	1	R104	430 Ω	CFR-25JB-430R	Yageo
42	1	R105	5.1 k Ω	CFR-25JB-5k1	Yageo
43	1	R32	27 k Ω (0805 pkg)		
44	1	T101	PC Standby X-former (EE16)	SIL6012	HICAL
45	1	U2	LED-PhotoXistor Opto-Coupler	SFH615A-2	Sharp
46	2	U102, U3	LED-PhotoXistor Opto-Coupler	LTV817	
47	3	U6, U7, U5	Precision Adj Shunt Regulator	TL431	
48	1	U101	Integrated Controller / MOSFET	TNY266P	Power Integrations
49	1		Printed Circuit Board	PCB	



7 Transformer Specification

7.1 180 W Forward Transformer

7.1.1 Electrical Diagram

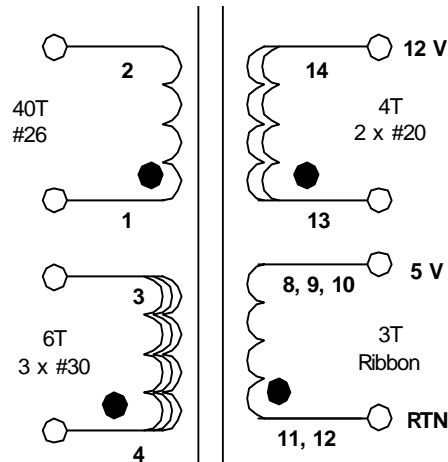

Figure 10 – 180 W Forward Transformer Electrical Diagram.

7.1.2 Electrical Specifications

Electrical Strength	1 minute, 60 Hz, from Pins 1-7 to Pins 10-14	3000 VAC
Primary Inductance	All windings open	3.0 mH or Higher
Resonant Frequency	All windings open	0.2 MHz (Min.)
Primary Leakage Inductance	Across pins 1–2, with Pins 8,9,10–11,12 3–4, and 13–14 shorted, measured at 100 kHz, 0.4 V _{RMS}	8 μH (Max.)

7.1.3 Materials

Item	Description
[1]	Core: PC40 EER28L–Z (TOK)
[2]	Jinn Bo Bobbins: #JB-0039
[3]	Magnet Wire: #26 AWG Heavy Nyleze
[4]	Magnet Wire: #30 AWG Heavy Nyleze
[5]	Magnet Wire: #20 AWG Heavy Nyleze
[6]	Copper ribbon (foil) 0.670" wide x 0.008" thick
[7]	Tape: 3M 1298 Polyester Film (white) 21.8 mm wide by 2.2 mils thick
[8]	Tape: 3M 1298 Polyester Film (white) 15.8 mm wide by 2.2 mils thick
[9]	Tape: 3M 44 Margin tape (cream) 3.0 mm wide by 5.5 mils thick

7.1.4 Transformer Build Diagram

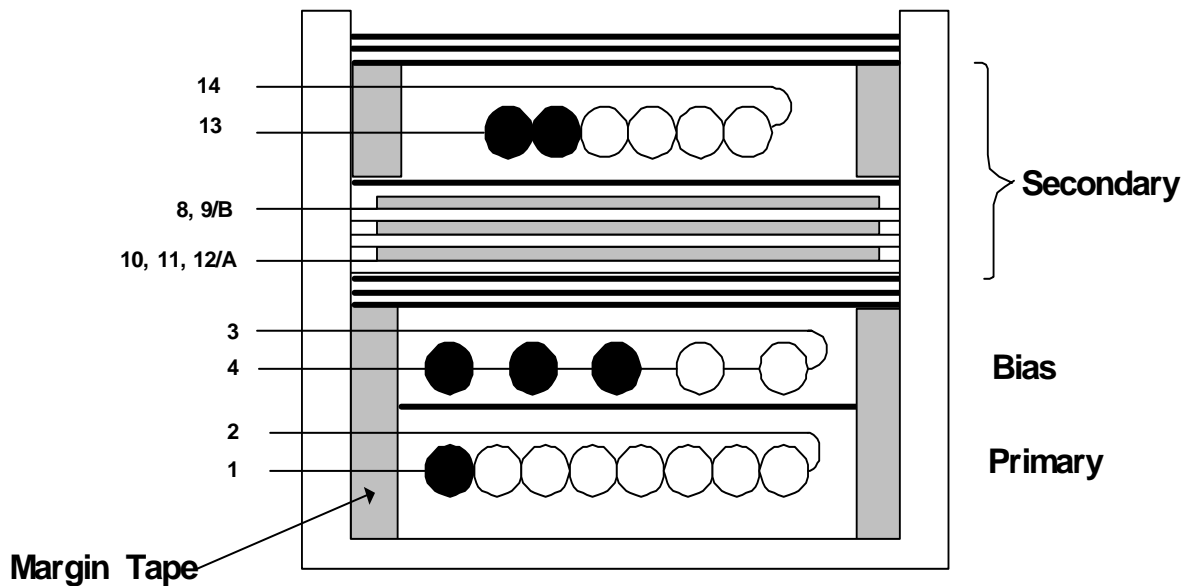

Figure 11 – 180 W Forward Transformer Build Diagram.

7.1.5 Transformer Construction

Margin Taping	Use item [9] for the right and left margins.
Primary Winding	Start at pin 1. Wind 40 turns of item [3] from left to right. Wind uniformly in a single layer across entire width of bobbin. End at pin 2.
Basic Insulation	1 Layer of tape [8] for basic insulation.
Margin Taping	Use item [9] for the right and left margins.
Bias Winding	Start at pin 4. Wind trifilar 6 turns of item [4] from left to right. Wind uniformly in a single layer across entire width of bobbin. End at pin 3.
Reinforced Insulation	3 Layer of tape [7] for insulation.
Copper Foil Winding (5 V)	Prepare copper ribbon [6] as shown in Figure 3. Match pin A of the foil to pin 10, 11, or 12 of the bobbin. Wind 3 turns of item [6]. Then, finish by matching pin B of the foil to pin 8 or 9 of the bobbin.
Reinforced Insulation	3 Layers of tape [7] for insulation.
Margin Taping	Use item [9] for the right and left margins.
12 V Winding	Start at pin 13. Wind bifilar 4 turns of item [5] from left to right. Wires are populated in middle of bobbin. Finish at pin 14.
Outer Insulation	Add 3 Layers of tape [7] for insulation.
Pins Clipped off	Pins 6 and 7.



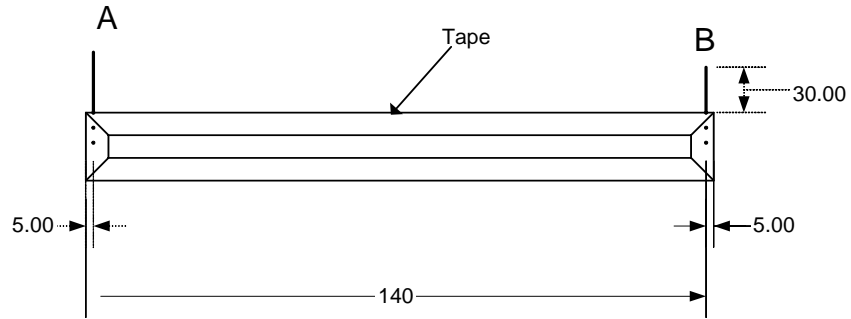

Figure 12 – 180 W Forward Transformer +5 V “Foil” Winding Preparation, Top View (in mm).

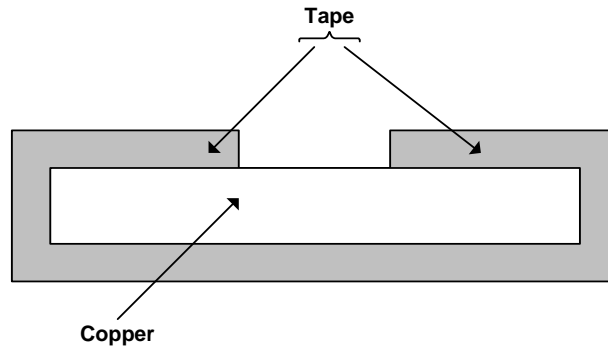

Figure 13 – 180 W Forward Transformer +5 V “Foil” Winding Preparation, End View.



7.2 10 W PC Standby Transformer

7.2.1 Electrical Diagram

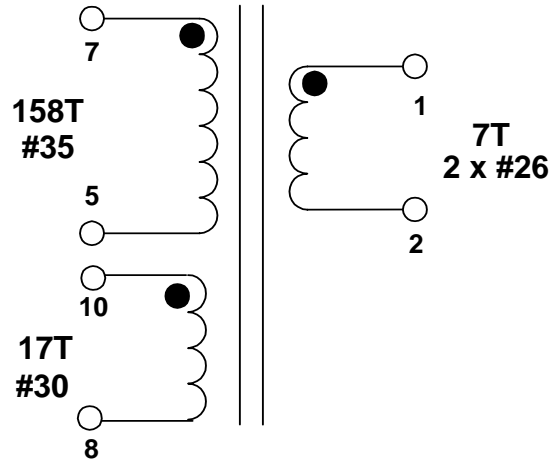

Figure 14 – 10 W PC Standby Transformer Electrical Diagram.

7.2.2 Electrical Specifications

Electrical Strength	1 minute, 60 Hz, from Pins 1-4 to Pins 5-10	3000 VAC
Primary Inductance	All windings open	2.3 mH
Resonant Frequency	All windings open	800 kHz (Min.)
Primary Leakage Inductance	Across pins 5–7, with Pins 8–10 and 1–2 shorted, measured at 100 kHz, 0.4 V _{RMS}	130 μH (Max.)

7.2.3 Materials

Item	Description
[1]	Core: EE16
[2]	Yih Hwa: #YW-193
[3]	Magnet Wire: #35 AWG Heavy Nyleze
[4]	Triple Insulated Wire: #26 AWG
[5]	Magnet wire #30 AWG Heavy Nyleze
[6]	Tape: 3M 1298 Polyester Film (white) 9.0 mm wide by 2.2 mils thick
[7]	Varnish (dipped only; NOT vacuum impregnated!)



7.2.4 Transformer Build Diagram

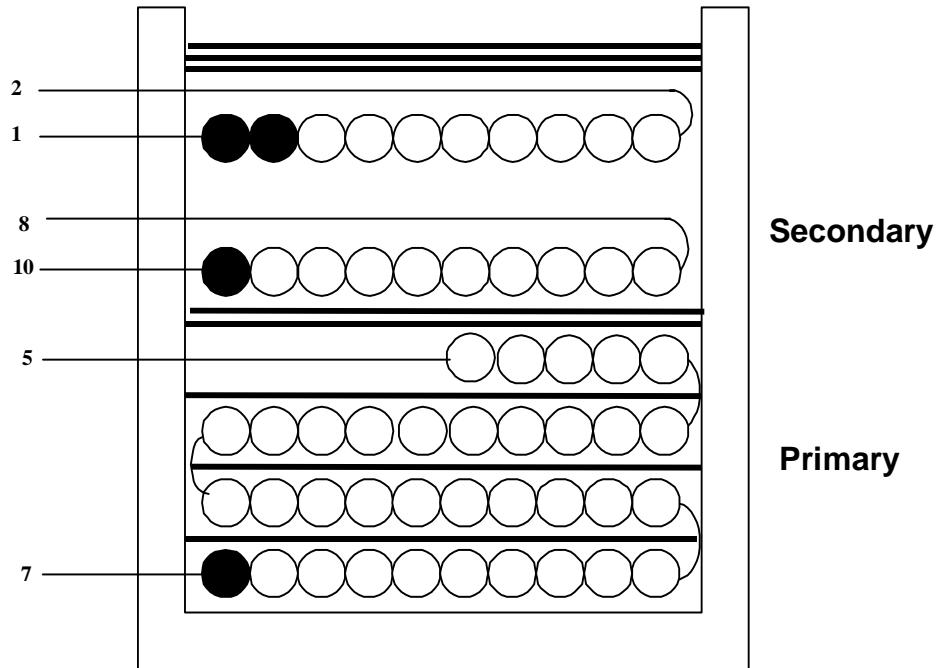

Figure 15 – 10 W PC Standby Transformer Build Diagram.

7.2.5 Transformer Construction

Primary Layer	Start at Pin 7. Wind 158 turns of item [3] from left to right, then from right to left until done. It takes about 3¼ layers. Apply 1 layer of tape, item [5], between each winding layer for basic insulation. Finish the wiring on Pin 5.
Basic Insulation	1 layer of tape [6] for insulation.
Bias Winding	Start at pin 10. Wind 17 turns of item [5] from left to right. Finish on pin 8.
Basic Insulation	1 Layer of tape [6] for insulation.
Secondary Winding	Start at Pin 1. Wind 7 bifilar turns of item [4] from left to right. Wind uniformly in a single layer across entire width of bobbin. Finish on Pin 2.
Outer Insulation	3 Layers of tape [6] for insulation.
Final Assembly	Assemble and secure core halves. Dip varnish uniformly [7].

7.3 Output Coupled Inductor

7.3.1 Toroid Layout

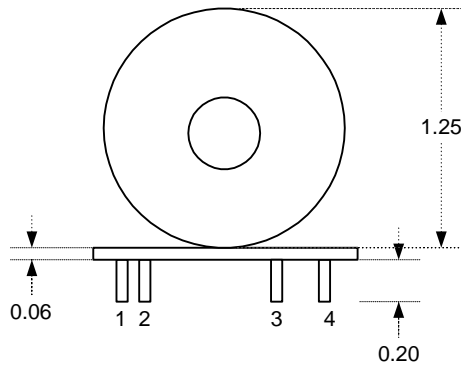

Figure 16 – Assembly Side View.

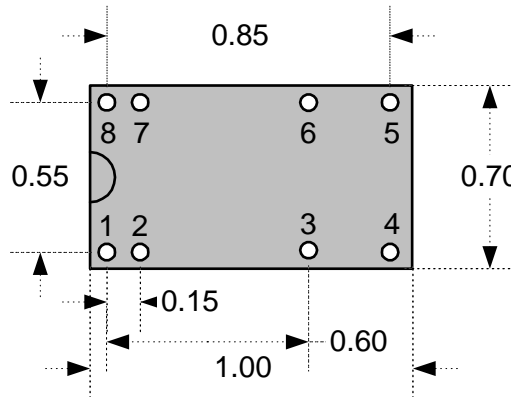

Figure 17 – Base Plate, Top View.

7.3.2 Electrical Diagram

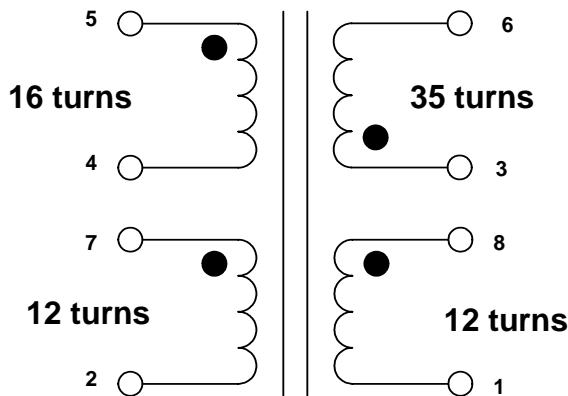

Figure 18 – Output Coupled Inductor Electrical Diagram.

7.3.3 Inductances

Pin #	AWG #	Color	# of Turns	Inductance (μH)
8-1	18	Red	12	$13 \pm 20\%$
7-2	18	Red	12	$13 \pm 20\%$
6-3	28	Red	35	$110 \pm 20\%$
5-4	18	Natural	16	$23 \pm 20\%$

Note:

1. All dimensions are ± 0.02 "
2. Core = T 106 – 26



7.4 Mag Amp Inductor

7.4.1 Core Specifications

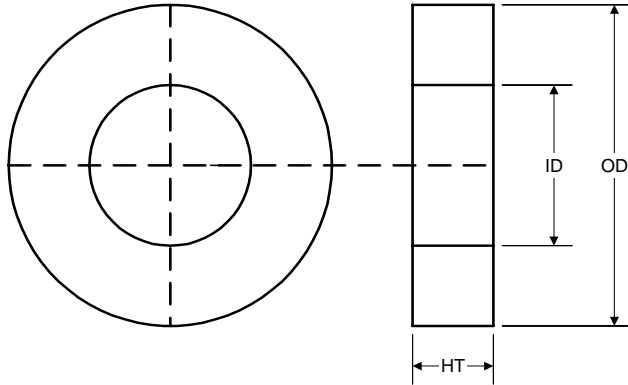

Figure 19 – Core Measurements.

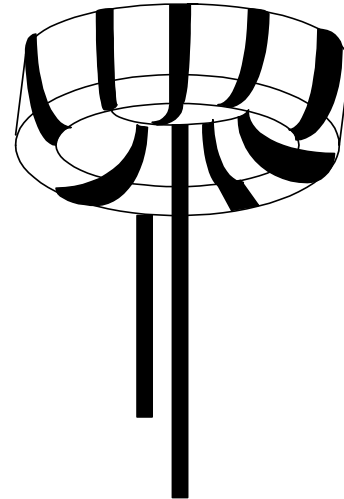

Figure 20 – Turns on the Core.

Core Number	OD (mm)	ID (mm)	HT (mm)
MP1305P-4AS	14.4	7.9	6.6

7.4.2 Winding Instructions

Use number 18 AWG wire gage heavy Nyleze wire to wind **7 turns** around the core as shown on Figure 17. Leave the wire legs about one inch long.



8 Transformer Spreadsheets

ACDC_TOPGXForward_Rev_1.06_061003 Copyright Power Integrations Inc. 2003				ACDC_TOPGXFwd_061003_r106.xls: TOPSwitch-GX Forward Transformer Design Spreadsheet	
	INPUT	INFO	OUTPUT	UNIT	
OUTPUT VOLTAGE AND CURRENT					
VMAIN	5			Volts	Main output voltage
IMAIN	12			Amps	Main output current
VMAINMA	3.3			Volts	Magamp output voltage
IMAINMA	12			Amps	Magamp output current
VAUX1	12			Volts	Auxiliary output voltage
IAUX1	7			Amps	Auxiliary output current
VIND1				Volts	Independant output voltage
IND1				Amps	Independent output current
PO			183.6	Watts	Total output power
ENTER APPLICATION VARIABLES					
VACMIN	90			AC volts	Minimum AC input voltage. Input voltage doubler circuit is assumed.
VACMAX	132			AC volts	Maximum AC input voltage. Input voltage doubler circuit is assumed.
VMIN			198	Volts	Minimum DC Bus voltage at low line input
VMAX			373	Volts	Maximum DC Bus voltage at high line input
CIN	235			uFarads	Equivalent bulk input capacitance. Input voltage doubler circuit is assumed.
fL	50			Hz	Input AC line frequency
tc	3.0			mSeconds	Estimate input bridge diode conduction time
th	16.0			mSeconds	Minimum required hold-up time from VDROPOUT to VHOLDUP
EFF	0.75				Efficiency estimate to determine minimum DC Bus voltage
VHOLDUP			198	Volts	DC Bus voltage at start of hold-up time (default VMIN)
VDROPOUT	132		132	Volts	DC Bus Voltage at end of hold-up time
DMAX GOAL	0.7		0.70		Maximum duty cycle at DC dropout voltage
VDSOP			580	Volts	Maximum operating drain voltage
KDI			0.15		Maximum output current ripple factor at maximum DC Bus voltage
REF AUX1	1			DC Stack	Enter one ('1') for DC stacked , zero ('0') Independent winding
ENTER TOPSWITCH VARIABLES					
TOPSwitch	top249				Doubled 115V/230V
Chosen Device	TOP249		Power Out		250
ILIMIT	5.022	5.778		Amps	From TOPSwitch-GX datasheet
fS	124000	132000		Hertz	From TOPSwitch-GX+H76 datasheet
KI	0.82				Ilimit reduction (KI=1.0 for default ILIMIT, KI <1.0 for lower ILIMIT)
RX			7.61	kOhm	Maximum current limit resistance to ensure KI >= 0.82 setting
ILIMITTEXT			4.118	Amps	External current limit
VDS			8.2	Volts	TOPSwitch-GX average on-state Drain to Source Voltage
DIODE Vf SELECTION					
VDMAIN			0.5	Volts	Main output rectifiers forward voltage drop (Schottky)
VDMAINMA			0.5	Volts	Magamp output rectifiers forward voltage drop (Schottky)
VDAUX1			0.7	Volts	Auxiliary output rectifiers forward voltage drop (Ultrafast)
VDIND1			0	Volts	Independent output rectifiers forward voltage drop (Schottky)
VDB			0.7	Volts	Bias output rectifier conduction drop
BRIDGE RECTIFIER DIODE SELECTION					
VPIVAC			467	Volts	Maximum voltage across Bridge rectifier diode
IDAVBR			0.962	Amps	Average Bridge Rectifier Current



TRANSFORMER CORE SELECTION**Core Type**

Core

Bobbin

AE

LE

AL

BW

LG MAX

R FACTOR

M

L

NMAIN

TRANSFORMER DESIGN PARAMETERS

NP

NB

NAUX1

VAUX1 ACTUAL

NIND1

VIND1 ACTUAL

BM**BP**

LP MIN

IMAG

OD_P

AWG_P

CURRENT WAVESHAPe PARAMETERS**IP**

IPRMS

INDUCTOR OUTPUT PARAMETERS

LMAIN

WLMAIN

KDIMAIN

LMAINMA

WLMAINMA

KDIMAINMA

LIND1

WLIND1

KDIIND1

SECONDARY OUTPUT PARAMETERS

ISMAINRMSLL

ISAUX1RMSLL

ISIND1RMSDLL

IDAVMAIN

eer28l

EER28L

EER28L_BOBBIN

P/N:

P/N:

0.814 cm²

7.55 cm

2520 nH/T²

21.8 mm

0.02 mm

9% %

3.0 mm

0.80

3

45

6

4

11.63 Volts

0

0.00 Volts

1816 Gauss**2922 Gauss**

3.419 mHenries

0.188 Amps

0.33 mm

28 AWG**3.079 Amps**

1.727 Amps

7.6 uHenries

3034 uJoules

0.150

12.3 uHenries

888 uJoules

0.150

0.0 uHenries

0.0 uJoules

0.000

17.36 Amps

4.23 Amps

0.00 Amps

14.6 Amps

PC40EER28L-Z

BEER-28L-1112CPH

Core Effective Cross Sectional Area

Core Effective Path Length

Ungapped Core Effective Inductance

Bobbin Physical Winding Width

Maximum actual gap when zero gap specified

Percentage of total PS losses lost in transformer windings; default 10%

Transformer margin

Transformer primary layers

Main rounded turns

Primary rounded turns

Bias turns to maintain 8V minimum input voltage, light load

Auxiliary rounded turns (DC stacked on Main winding)

Approx. Aux output voltage with NAUX1 = 4 Turns and DC stack

Independent rounded turns (separate winding)

Approximate Independent output voltage with NIND1 = 0 turns

Maximum operating flux density at minimum switching frequency

Maximum peak flux density at minimum switching frequency

Minimum primary magnetizing inductance (assumes LGMAX=20um)

Peak magnetizing current at minimum input voltage

Primary wire outer diameter

Primary Wire Gauge (rounded to maximum AWG value)

Maximum peak primary current at maximum DC Bus voltage

Maximum primary RMS current at minimum DC Bus voltage

Main / Auxiliary coupled output inductance (referred to Main winding)

Main / Auxiliary coupled output inductor full-load stored energy

Current ripple factor of combined Main and Aux1 outputs

Magamp output inductance

Magamp output inductor full-load stored energy

Current ripple factor for Magamp output

Independent output inductance

Independent output inductor full-load stored energy

Current ripple factor for Independent output

Maximum transformer secondary RMS current (DC Stack)

Maximum transformer secondary RMS current (DC Stack)

Maximum transformer secondary RMS current

Maximum average current, Main rectifier (single device rating)



IDAVMAINMA	9.3 Amps	Maximum average current, Magamp rectifier (single device rating)
IDAVAUX1	5.4 Amps	Maximum average current, Auxiliary rectifier (single device rating)
IDAVIND1	0.0 Amps	Maximum average current, Independent rectifier (single device rating)
IRMSMAIN	0.52 Amps	Maximum RMS current, Main output capacitor
IRMSMAINMA	0.52 Amps	Maximum RMS current, Magamp output capacitor
IRMSAUX1	0.30 Amps	Maximum RMS current, Auxiliary output capacitor
IRMSIND1	0.00 Amps	Maximum RMS current, Independent output capacitor
DIODE PIV		<i>No derating</i>
VPIVMAIN	28.8 Volts	Main output rectifiers peak-inverse voltage
VPIVMAINMA	28.8 Volts	Magamp output rectifiers peak-inverse voltage
VPIVAUX1	34.0 Volts	Auxiliary output rectifiers peak-inverse voltage
VPIVIND1	0.0 Volts	Independent output rectifiers peak-inverse voltage
VPIVB	100.7 Volts	Bias output rectifier peak-inverse voltage
VCEO OPTO	49.8 Volts	Maximum optocoupler collector-emitter voltage
VACUVL	68 AC volts	AC undervoltage lockout voltage; On-Off transition
VACUV	78 AC volts	AC undervoltage lockout voltage; Off-On transition
VACUVX	68.04	
RUVA	2.23 MOhm	Resistor RUVA value
RUVB	658.78 kOhm	Resistor RUVB value
RUVC	75.91 kOhm	Resistor RUVC value
VACUVL ACTUAL	67.5 AC volts	Actual AC undervoltage lockout voltage; On-Off transition
VACUVX ACTUAL	70.36 AC volts	Actual AC undervoltage lockout voltage; Off-On transition
DUTY CYCLE LIMIT CIRCUIT PARAMETERS		
VZ	6.80 Volts	Zener voltage used within DLIM circuit
VOV	380 Volts	Approximate frequency reduction voltage (determines CVS value)
RA	2.20 MOhm	Resistor RA value
RB	2.20 MOhm	Resistor RB value
RC	37.90 kOhm	Resistor RC value
RD	137.30 kOhm	Resistor RD value
CVS	85.80 pF	Capacitor CVS value
DUTY CYCLE PARAMETERS (see graph)		
DMAX ACTUAL	0.694	Operating Duty cycle at DC Bus dropout voltage
DMAX RESET	0.79	Transformer Reset Minimum duty cycle at DC Bus dropout voltage
DXDO MIN	0.70	Device Min Duty cycle limit at DC Bus dropout voltage
DXDO MAX	0.80	!!! >DMAXRESET from VMIN to VDROPOUT. NOT hazardous
DLL ACTUAL	0.45	Duty cycle at minimum DC Bus voltage
DXLL MIN	0.54	Duty cycle minimum limit at minimum DC Bus voltage
DXLL MAX	0.65	Duty cycle maximum limit at minimum DC Bus voltage
DLL RESET	0.67	Minimum duty cycle to reset transformer at low line
High Line Duty-Cycle Parameters		
DHL ACTUAL	0.23	Duty cycle at minimum DC Bus voltage
DXHL MIN	0.24	Duty cycle minimum limit at maximum DC Bus voltage
DXHL MAX	0.35	Duty cycle maximum limit at maximum DC Bus voltage
DHL RESET	0.36	Minimum duty cycle to reset transformer at high line



9 Performance Data

9.1 Efficiency and Regulation

Input VAC	Output Current					Output Voltage					P OUT (W)	P IN (W)	Eff (%)
	+5 V	+12 V	+3.3 V	+5 VSB	-12 V	+5 V	+12 V	+3.3 V	+5 VSB	-12 V			
	(A)	(A)	(A)	(A)	(A)	(V)	(V)	(V)	(V)	(V)			
115	2	3	16.7	1.5	0	5.09	12.02	3.38	4.91	-12.00	108.61	153	70.99
115	12	3	0.5	2	0	5.04	12.26	3.38	4.88	-12.00	107.5	140	76.79
115	2	10	0.5	0	0.3	5.15	11.79	3.38	4.88	-12.04	145.35	169	86.01
115	2	10	12	2	0.3	5.07	11.72	3.27	5.08	-11.98	180	245	73.47
90	2	3	16.7	1.5	0	5.13	12.15	3.26	4.87	-12.00	108.6	156	69.62
90	12	3	0.5	2	0	5.04	12.27	3.3	4.88	-12.00	107.5	145	74.14
90	2	10	0.5	0	0.3	5.07	11.79	3.38	4.88	-12.02	145.35	173	84.02
90	2	10	12	2	0.3	5.07	11.72	3.24	5.08	-12.04	180	253	71.15
230				0.5	0				5.02		2.5	3.4	73.53
115	0.4	0.2000	0.5	1.5	0						14.85	25.2	58.93

<1 watt input power spec (+5 V standby loaded to 0.5 W and main supply off at 115 VAC input). Input power is **0.86 W**.

If interconnect board is used, subtract 0.07 W (standby LED consumption) from input power measurement.

Blue Angel (240 VAC input, Main convert inhibited, +5 V standby loaded to 2.5 A). Input power is **4.1 W**.



10 Thermal Performance

Thermal test taken at 90 VAC (worst case condition).
Ambient Temperature is 50 °C.

Output loads: +5 V/8 A, +3.3 V/8 A, +12 V/9 A, +5 V standby/1.5 A.

Device	Temp (°C)
U1 (TOP249)	91
L1 (Output Choke)	83
Passive PFC Choke	78
D8 (+5 V Output Diode)	88
T1 (Main Transformer)	71
L7 (Input Ballun)	68
BR1 (Input Bridge)	62



11 Waveforms

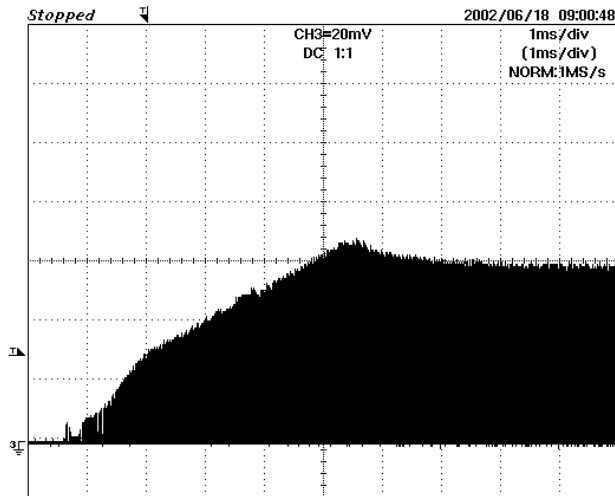

Figure 21 – Primary Drain Current at Start-up, Activated from Remote ON/OFF at 120 VAC Input.
 +5 V / 8 A, +12 V / 9 A, +3.3 V / 8 A,
 +5 V Standby / 1.5 A (0.5 A / division)

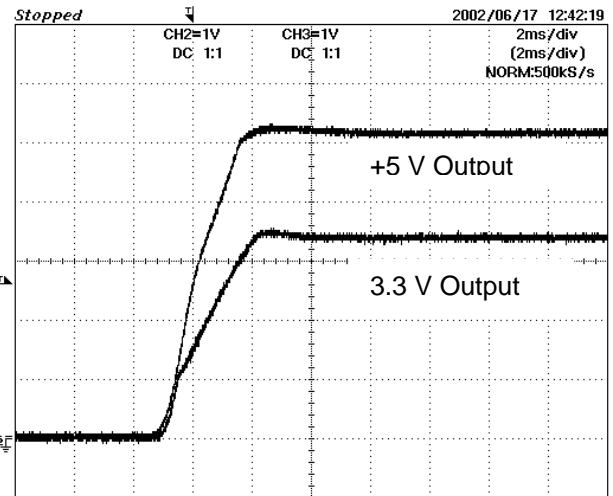

Figure 22 – +5 V and +3.3 V Rise at Turn-on from Remote ON/OFF, 120 VAC Input.
 +5 V / 8 A, +3.3 V / 8 A, +12 V / 9 A,
 +5 V Standby / 1.5 A

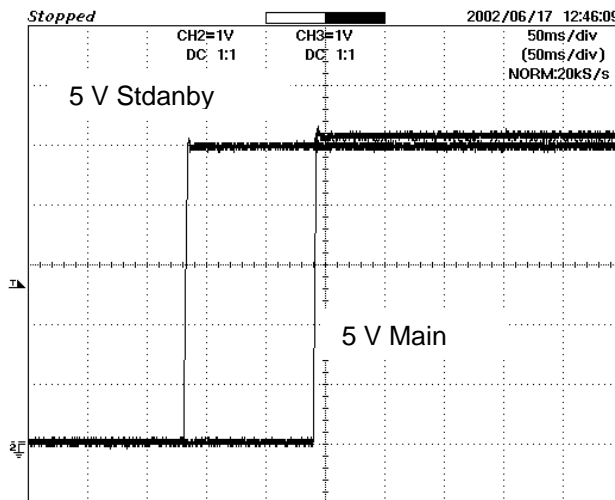

Figure 23 – +5 V Main and +5 V Standby Start-up (120 VAC). Max Load on all Outputs.

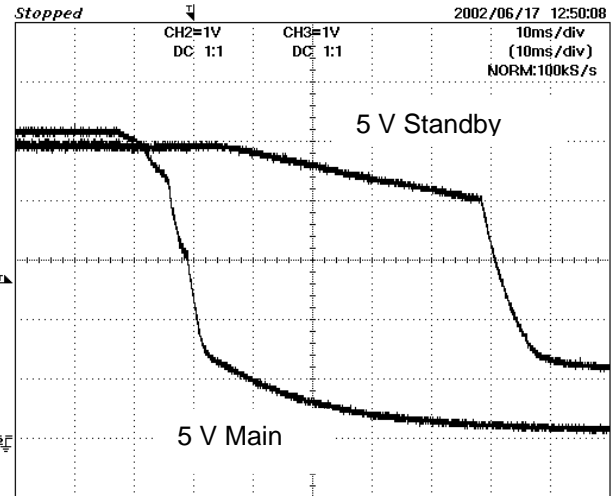

Figure 24 – +5 V and +5 V Standby Dropout After AC OFF. Max Load on 5 V Standby, Min Load on all Other Outputs.



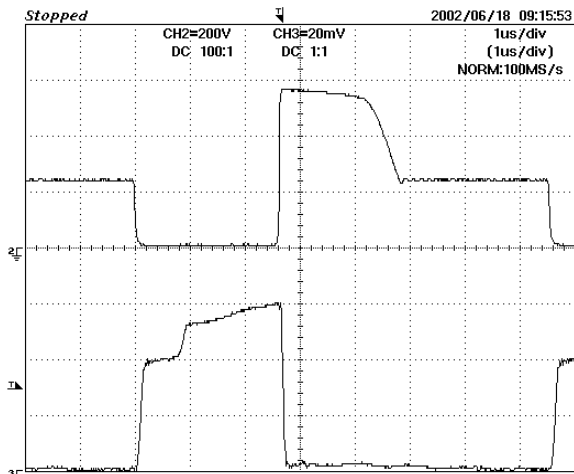

Figure 25 – TOP249 Drain Switching Waveform, +5 V at 8 A, +3.3 V at 8 A, +12 V at 9 A, 110 VAC Input.

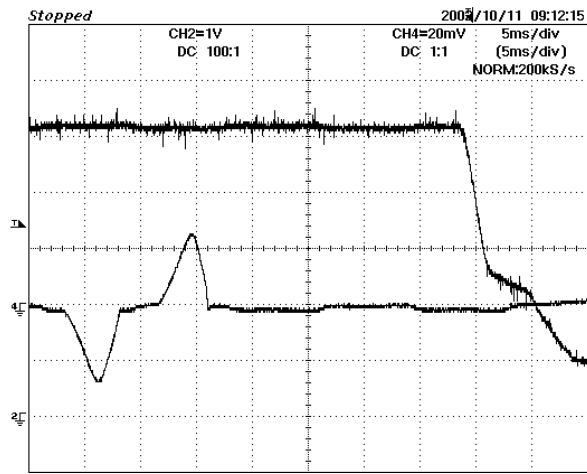

Figure 26 – 110 VAC Applied Line Terminated with Following Loads: +5 V at 13 A, +3.3 V at 6 A, +12 V at 8 A.

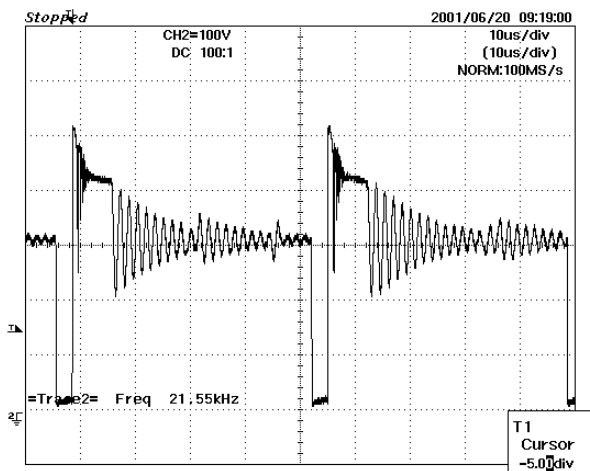

Figure 27 – Drain Switching Voltage of TNY266 (PC Standby). 230 VAC Input, +5 V Standby Output Loaded to 1.5 A.

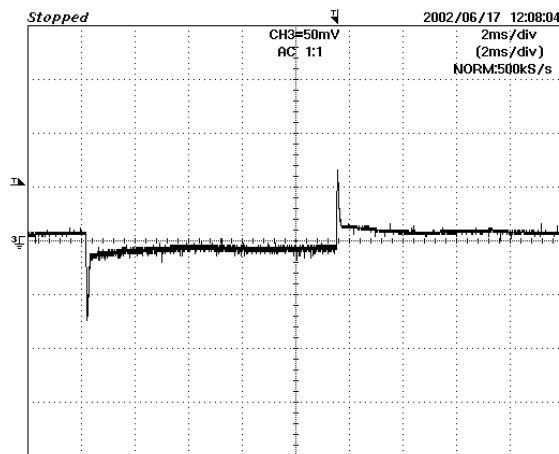

Figure 28 – +5 V (Main) Step Load (2 A to 8 A), Max Continuous Load on Other Outputs.

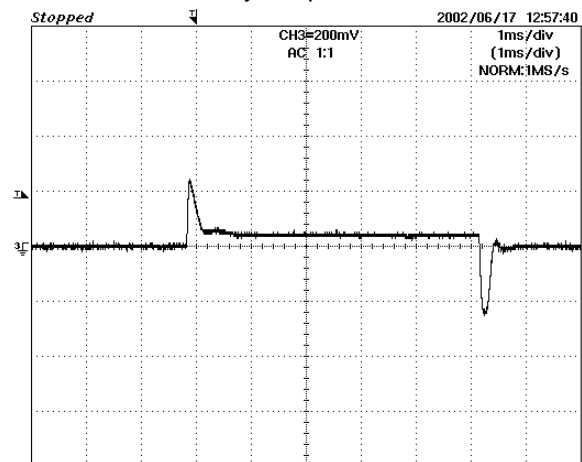

Figure 29 – +3.3 V Step Load 6 A to 12 A.

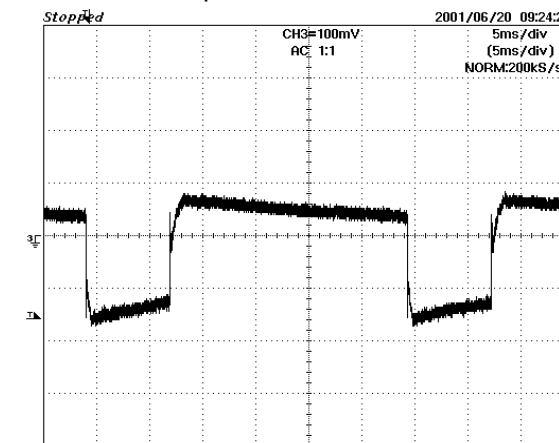

Figure 30 – +5 V Standby Step Load 0.3 A to 1.5 A.



12 Output Ripple Measurements

12.1 Ripple Measurement Technique

For DC output ripple measurements, a modified oscilloscope test probe must be utilized in order to reduce spurious signals due to pickup. Details of the probe modification are provided in Figure 31 and Figure 32.

The 5125BA probe adapter is affixed with two capacitors tied in parallel across the probe tip. The capacitors include one (1) 0.1 $\mu\text{F}/50\text{ V}$ ceramic type and one (1) 1.0 $\mu\text{F}/50\text{ V}$ aluminum electrolytic. **The aluminum electrolytic type capacitor is polarized, so proper polarity across DC outputs must be maintained (see below).**

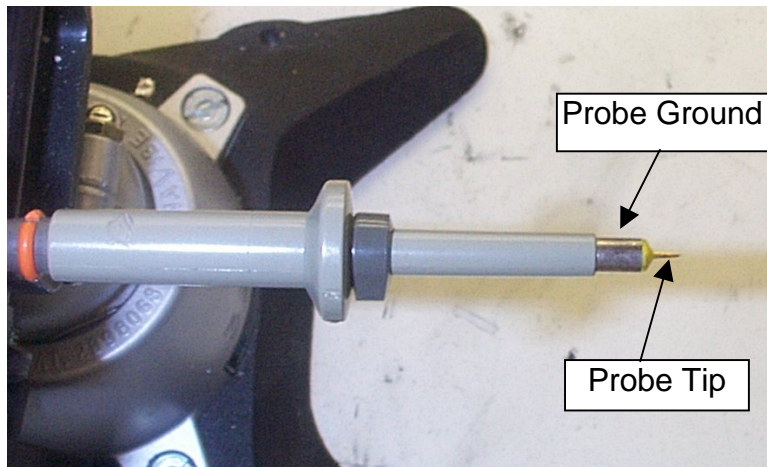

Figure 31 – Oscilloscope Probe Prepared for Ripple Measurement (End Cap and Ground Lead Removed).



Figure 32 – Oscilloscope Probe with Probe Master 5125BA BNC Adapter (Modified for ripple measurement: wires for probe tip and ground with two decoupling capacitors connected in parallel).

12.2 Measurement Results

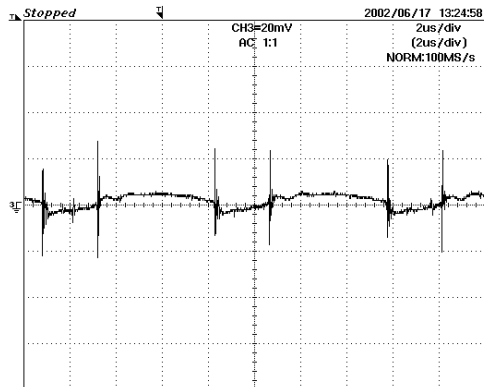

Figure 33 – +12 V Output Ripple,
Load: +12 V / 8 A, +5 V / 8 A, +3.3 V /
8 A, +5 V Standby / 1.5 A, -12 V /
0.2 A (2 μ s and 20 mV / division).

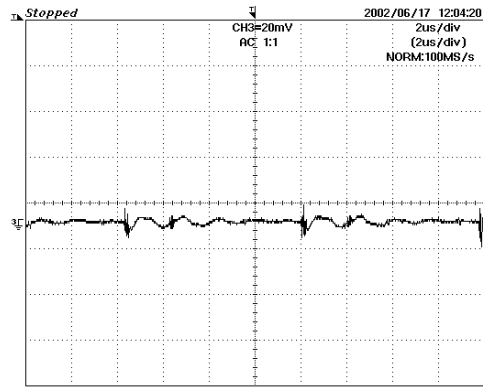

Figure 34 – +5 V Output Ripple,
Load: +12 V / 8 A, +5 V / 8 A, +3.3 V /
8 A, +5 V Standby / 1.5 A, -12 V /
0.2 A (2 μ s and 20 mV / division).

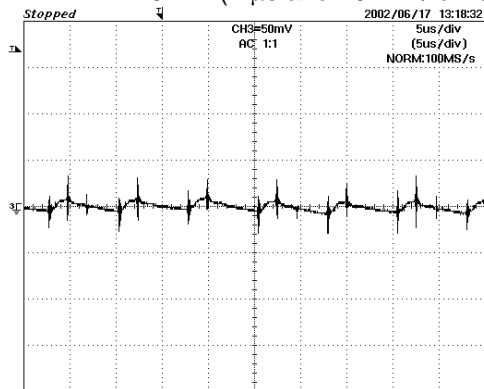

Figure 35 – +3.3 V Output Ripple,
Load: +12 V / 8 A, +5 V / 8 A, +3.3 V /
8 A, +5 V Standby / 1.5 A, -12 V /
0.2 A (5 μ s and 50 mV / division).

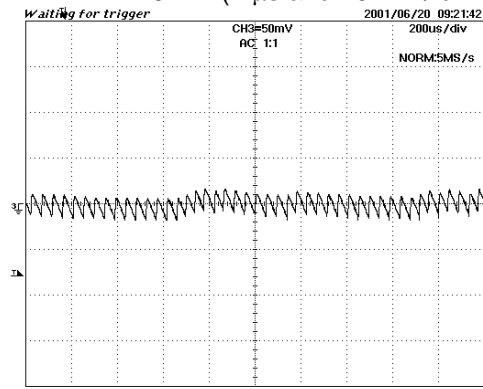

Figure 36 – +5 V Standby Output Ripple,
Load: +12 V / 8 A, +5 V / 8 A, +3.3 V /
8 A, +5 V Standby / 1.5 A, -12 V /
0.2 A (200 μ s and 50 mV / division).

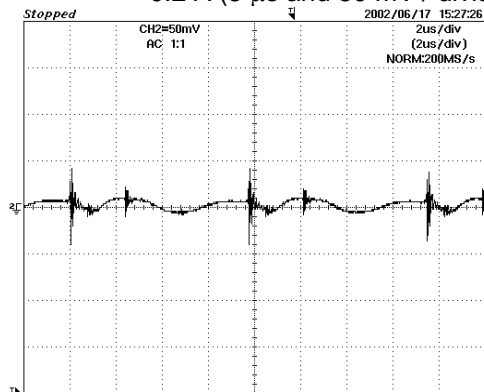

Figure 37 – -12 V Output Ripple,
Load: +12 V / 8 A, +5 V / 8 A, +3.3 V /
8 A, +5 V Standby / 1.5 A, -12 V /
0.2 A (2 μ s and 50 mV / division).



13 Conducted EMI

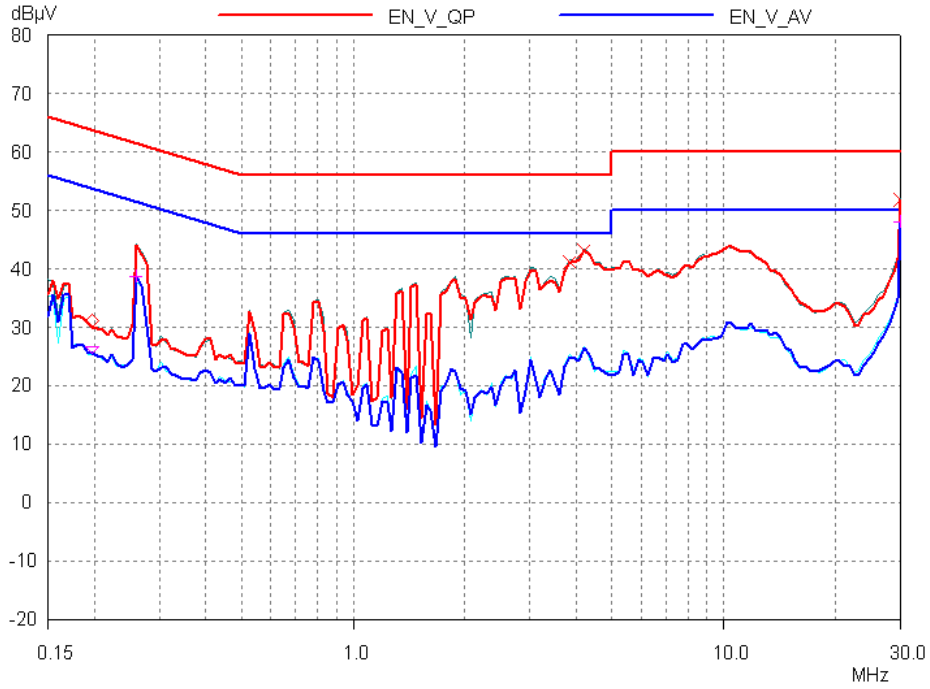

Figure 38 – Conducted EMI, Maximum Steady State Load, 115 VAC, 60 Hz, and EN55022 B Limits.



Figure 39 – Conducted EMI, Maximum Steady State Load, 230 VAC, 60 Hz, and EN55022 B Limits.



14 Revision History

Date	Author	Revision	Description & changes
14-Sep-02	AO	0.1	First Draft
15-May-03	AO	0.3	Second Draft
20-Jun-03	AO	0.3	Third Draft
28-Jul-03	IM	0.4	Formatting for first release
01-Oct-03	JJ	0.5	Editing Content for first release
18-Dec-03	IM	1.0	Release of the first edition
01-Feb-05	AO	1.1	Corrected item 44 description on page 16 and inserted missing Figure 14



Notes



For the latest updates, visit our website: www.powerint.com

Power Integrations may make changes to its products at any time. Power Integrations has no liability arising from your use of any information, device or circuit described herein nor does it convey any license under its patent rights or the rights of others. POWER INTEGRATIONS MAKES NO WARRANTIES HEREIN AND SPECIFICALLY DISCLAIMS ALL WARRANTIES INCLUDING, WITHOUT LIMITATION, THE IMPLIED WARRANTIES OF MERCHANTABILITY, FITNESS FOR A PARTICULAR PURPOSE, AND NON-INFRINGEMENT OF THIRD PARTY RIGHTS.

PATENT INFORMATION

The products and applications illustrated herein (including circuits external to the products and transformer construction) may be covered by one or more U.S. and foreign patents or potentially by pending U.S. and foreign patent applications assigned to Power Integrations. A complete list of Power Integrations' patents may be found at www.powerint.com.

The PI Logo, **TOPSwitch**, **TinySwitch**, **LinkSwitch**, **DPA-Switch** and **EcoSmart** are registered trademarks of Power Integrations. **PI Expert** and **PI FACTS** are trademarks of Power Integrations. © Copyright 2005 Power Integrations.

Power Integrations Worldwide Sales Support Locations

WORLD HEADQUARTERS

5245 Hellyer Avenue,
San Jose, CA 95138, USA
Main: +1-408-414-9200
Customer Service:
Phone: +1-408-414-9665
Fax: +1-408-414-9765
e-mail: usasales@powerint.com

GERMANY

Rueckertstrasse 3,
D-80336, Munich, Germany
Phone: +49-895-527-3910
Fax: +49-895-527-3920
e-mail: eurosales@powerint.com

JAPAN

Keihin-Tatemono 1st Bldg.
12-20 Shin-Yokohama,
2-Chome,
Kohoku-ku, Yokohama-shi,
Kanagawa 222-0033, Japan
Phone: +81-45-471-1021
Fax: +81-45-471-3717
e-mail: japansales@powerint.com

TAIWAN

5F-1, No. 316, Nei Hu Rd., Sec. 1
Nei Hu Dist.
Taipei, Taiwan 114, R.O.C.
Phone: +886-2-2659-4570
Fax: +886-2-2659-4550
e-mail: taiwansales@powerint.com

CHINA (SHANGHAI)

Rm 807-808A, Pacheer,
Commercial Centre,
555 Nanjing West Road,
Shanghai, 200041, China
Phone: +86-21-6215-5548
Fax: +86-21-6215-2468
e-mail: chinasales@powerint.com

INDIA (TECHNICAL SUPPORT)

261/A, Ground Floor
7th Main, 17th Cross,
Sadashivanagar
Bangalore 560080
Phone: +91-80-5113-8020
Fax: +91-80-5113-8023
e-mail: indiasales@powerint.com

KOREA

RM 602, 6FL
Korea City Air Terminal B/D,
159-6,
Samsung-Dong, Kangnam-Gu,
Seoul, Korea
Phone: +82-2-2016-6610
Fax: +82-2-2016-6630
e-mail: koreasales@powerint.com

UK (EUROPE & AFRICA HEADQUARTERS)

1st Floor, St. James's House
East Street
Farnham, Surrey GU9 7TJ
United Kingdom
Phone: +44 (0) 1252-730-140
Fax: +44 (0) 1252-727-689
e-mail: eurosales@powerint.com

CHINA (SHENZHEN)

Room 2206-2207, Block A,
Electronics Science & Technology
Bldg.,
2070 Shennan Zhong Road,
Shenzhen, Guangdong,
China, 518031
Phone: +86-755-8379-3243
Fax: +86-755-8379-5828
e-mail: chinasales@powerint.com

ITALY

Via Vittorio Veneto 12,
Bresso
Milano, 20091, Italy
Phone: +39-028-928-6001
Fax: +39-028-928-6009
e-mail: eurosales@powerint.com

SINGAPORE

51 Newton Road,
#15-08/10 Goldhill Plaza,
Singapore, 308900
Phone: +65-6358-2160
Fax: +65-6358-2015
e-mail: singaporesales@powerint.com

APPLICATIONS HOTLINE

World Wide +1-408-414-9660

APPLICATIONS FAX

World Wide +1-408-414-9760



Power Integrations

Tel: +1 408 414 9200 Fax: +1 408 414 9201
www.powerint.com