



Title	<i>Engineering Prototype Report for EP-34 – Single Output 30 W AC-DC Power Supply Using TOP245Y (TOPSwitch®-GX)</i>
Specification	Universal Input, 12 V at 30 W Output
Application	Generic
Author	Power Integrations Applications Department
Document Number	EPR-34
Date	10-Feb-04
Revision	1.1

Features

- Universal Input 85 VAC to 265 VAC
- Low Parts Count
- Zero Load Power Consumption <0.3 W at 115 VAC, <0.45 W at 230 VAC
- Meets CISPR22B EMI with Margin
- Efficiency >80%

The products and applications illustrated herein (including circuits external to the products and transformer construction) may be covered by one or more U.S. and foreign patents or potentially by pending U.S. and foreign patent applications assigned to Power Integrations. A complete list of Power Integrations' patents may be found at www.powerint.com.

Table Of Contents

1	Introduction.....	4
2	Power Supply Specification	5
3	Schematic.....	6
4	Circuit Description	7
4.1	Input EMI Filtering	7
4.2	<i>TOPSwitch</i> Primary	7
4.3	Output Rectification	7
4.4	Output Feedback.....	7
5	PCB Layout	9
6	Bill Of Materials	10
7	Transformer Specification.....	11
7.1	Electrical Diagram	11
7.2	Electrical Specifications.....	11
7.3	Materials.....	11
7.4	Transformer Build Diagram	12
7.5	Transformer Construction.....	12
7.6	Transformer Sources.....	12
8	Transformer Spreadsheets.....	13
9	Performance Data	15
9.1	Efficiency.....	15
9.2	No-load Input Power.....	15
9.3	Regulation	16
9.3.1	Load	16
9.3.2	Line	16
9.4	Overload Power.....	17
10	Thermal Performance	18
11	Waveforms.....	19
11.1	Drain Voltage and Current, Normal Operation.....	19
11.2	Output Voltage Start-up Profile.....	19
11.3	Drain Voltage and Current Start-up Profile	19
11.4	Load Transient Response (75% to 100% Load Step)	20
11.5	Output Ripple Measurements.....	21
11.5.1	Ripple Measurement Technique	21
11.5.2	Measurement Results	22
12	Control Loop Measurements.....	23
12.1	115 VAC Maximum Load.....	23
12.2	230 VAC Maximum Load.....	23
13	Conducted EMI	24
14	AC Surge and 100 kHz Ring Wave Immunity	25
14.1	Common Mode Surge, 1.2/50 μ s.....	25
14.2	Differential Mode Surge, 1.2/50 μ s.....	26
14.3	Common Mode, 100 kHz Ring Wave	26
14.4	Differential Mode, 100 kHz Ring Wave.....	26
15	Revision History	27

Important Note:

Although the EP-34 is designed to satisfy safety isolation requirements, the engineering prototype has not been agency approved. Therefore, all testing should be performed using an isolation transformer to provide the AC input to the prototype board.

1 Introduction

This document is an engineering report describing a 12 V, 30 W universal input flyback power supply, intended as a standard evaluation platform for *TOPSwitch-GX*.

The document contains the power supply specification, schematic, bill of materials, transformer documentation, printed circuit board layout, and performance data.

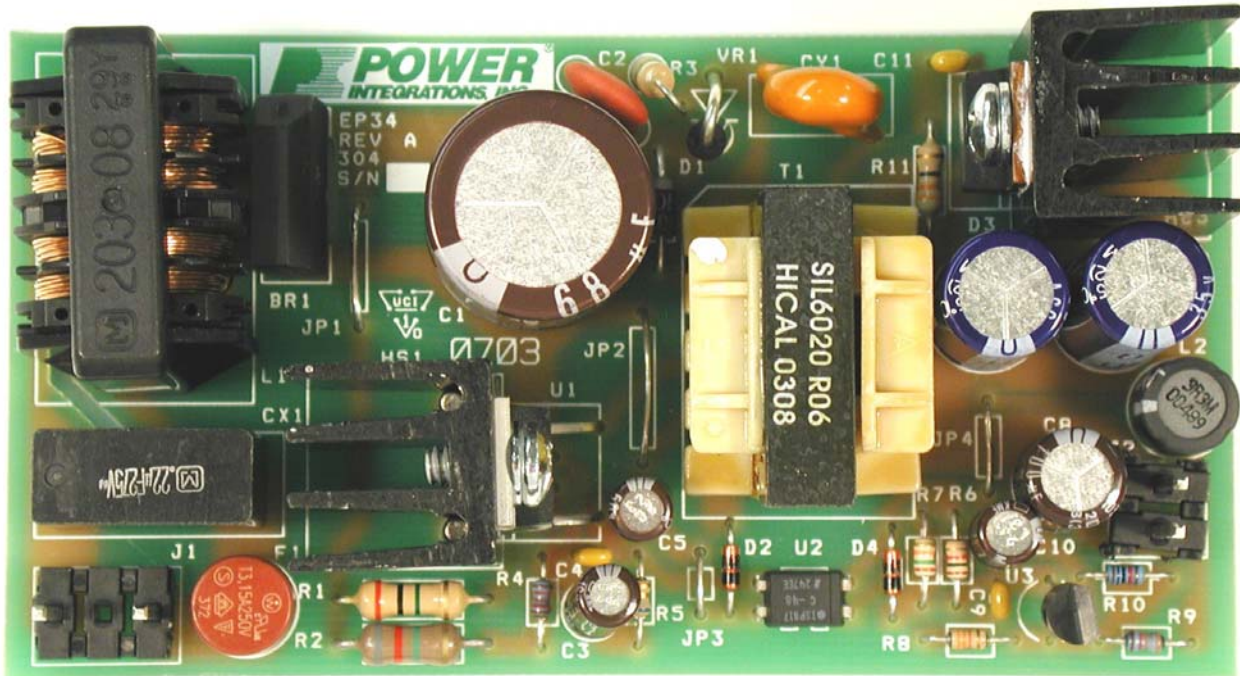

Figure 1 – EP-34 Populated Circuit Board.

2 Power Supply Specification

Description	Symbol	Min	Typ	Max	Units	Comment
Input						
Voltage	V_{IN}	85		265	VAC	2 Wire – no P.E.
Frequency	f_{LINE}	47	50/60	64	Hz	
No-load Input Power (230 VAC)				0.45	W	
Output						
Output Voltage	V_{OUT}	11.4	12.00	12.6	V	± 5% 20 MHz Bandwidth
Output Ripple Voltage	V_{RIPPLE}			150	mV	
Output Current	I_{OUT}	0	2.5		A	
Total Output Power						
Continuous Output Power	P_{OUT}		30		W	
Efficiency	η	80			%	Measured at P_{OUT} (30 W), 25 °C
Environmental						
Conducted EMI						Meets CISPR22B / EN55022B Designed to meet IEC950, UL1950 Class II
Safety						
Surge		4			kV	1.2/50 μ s surge, IEC 1000-4-5, 2 / 12 Ω series impedance, differential common mode
Surge		3			kV	100 kHz ring wave, 500 A short circuit current, differential and common mode
Ambient Temperature	T_{AMB}	0		50	°C	Free convection, sea level

3 Schematic

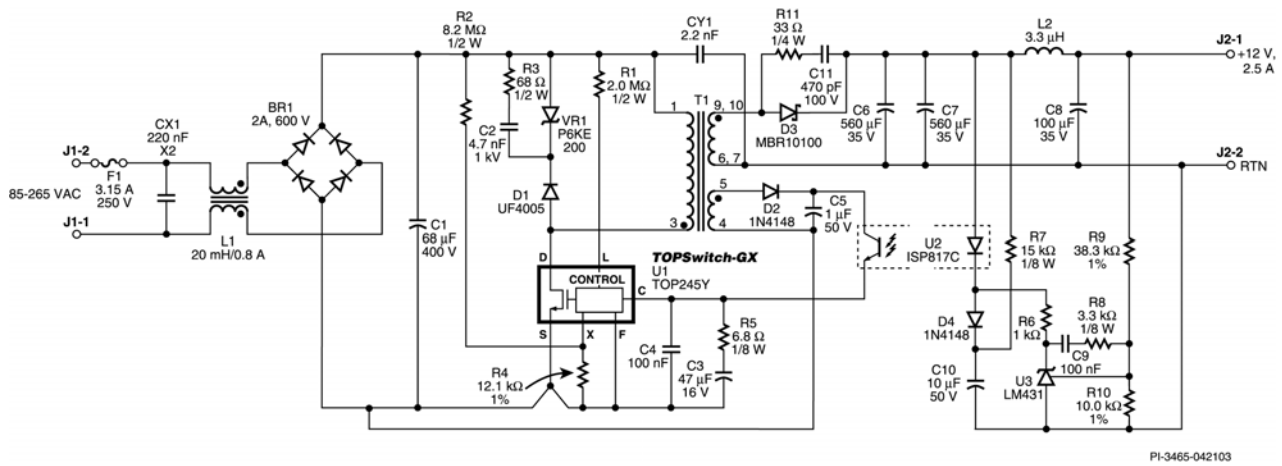

Figure 2 – EP-34 Schematic.

PI-3465-042103

4 Circuit Description

The schematic in Figure 2 shows an off-line flyback converter using the TOP245Y. The circuit is designed for 85 VAC to 265 VAC input and provides an isolated 12 V, 2.5 A output.

4.1 Input EMI Filtering

Capacitor CX1 and the leakage inductance of L1 filter differential mode conducted EMI. Inductor L1 and CY1 filter common mode conducted EMI.

4.2 TOPSwitch Primary

Rectifier bridge BR1 and C1 provide a high voltage DC supply rail for the primary circuitry. The DC rail is applied to the primary winding of T1. The other side of the transformer primary is driven by the integrated MOSFET in U1. Diode D1 and VR1 clamp leakage spikes generated when the MOSFET in U1 switches off. Capacitor C2 reduces the operating temperature of VR1 by bypassing the leading edge of the primary leakage spike away from VR1. Resistor R3 provides damping to reduce drain ringing improving EMI. Resistor R1 sets the low-line turn-on threshold to approximately 69 VAC and sets the overvoltage shutdown level to approximately 320 VAC. Resistor R4 sets the U1 current limit to approximately 70% of its nominal value. Resistor R2 reduces the U1 current limit as a function of line voltage so that maximum overload power is relatively constant (<50 W) over the entire input voltage range. This limits the output power delivered during fault conditions. Capacitor C4 bypasses the U1 CONTROL pin while C3 has three functions. It provides the energy required by U1 during startup, sets the auto-restart frequency during fault conditions, and also acts to roll off the gain of U1 as a function of frequency. Resistor R5 adds a zero to the control loop to stabilize the power supply. Diode D2 and capacitor C5 provide rectified and filtered bias power for U2 and U1.

4.3 Output Rectification

The secondary of T1 is rectified and filtered by D3, C6, and C7. Inductor L2 and C8 provide additional high frequency filtering. Resistor R11 and C11 provide snubbing for D3. Choosing the proper snubber values is important for low zero-load power consumption and for high frequency EMI suppression. The snubber components were chosen so that the turn-on voltage spike at the D3 anode is slightly under-damped. Increasing C11 and reducing R11 will improve damping and high frequency EMI, at the cost of higher zero load power consumption.

4.4 Output Feedback

Resistors R9 and R10 divide down the supply output voltage and apply it to the reference pin of error amplifier U3. Shunt regulator U3 drives the LED of optocoupler U2 through resistor R6 to provide feedback information to the U1 CONTROL pin. The optocoupler output also provides power to U1 from the bias winding during normal operating conditions. Diode D4 and capacitor C10 apply drive to the optocoupler during supply

startup to reduce output voltage overshoot (soft finish network). Diode D4 also isolates C10 from the supply feedback loop after startup. Resistor R7 discharges C10 when the supply is off.

Components C3, C9, R5, R6, and R8 all play a role in compensating the power supply control loop. Capacitor C3 rolls off the gain of U1 at relatively low frequency. Resistor R5 provides a zero to cancel the phase shift of C5. Resistor R6 sets the gain of the direct signal path from the supply output through U2 and U3. Components C9 and R8 roll off the gain of U3.

5 PCB Layout

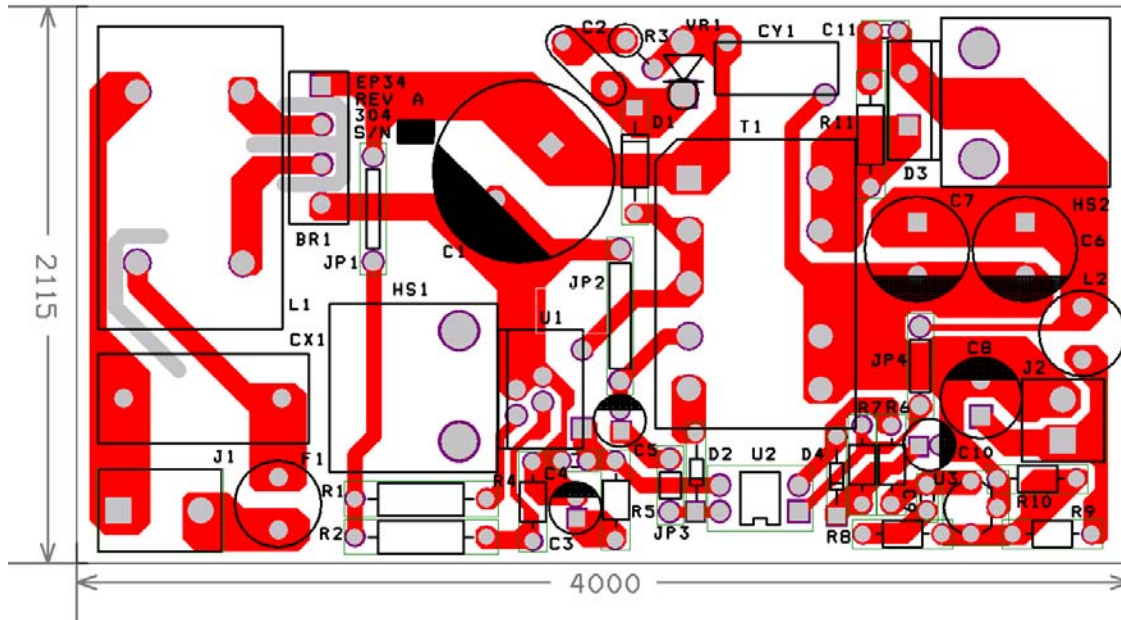

Figure 3 – EP-34 Printed Circuit Board Layout (dimensions 0.001”).

6 Bill Of Materials

EP-34 – 12 V, 30 W TOPSwitch-GX Evaluation Board Bill Of Materials

Item	Qty	Reference	Description	P/N	Manufacturer
1	1	U1	TOPSwitch-GX IC	TOP245Y	Power Integrations
2	1	U2	Optocoupler, controlled CTR	ISP817C	Isocom
3	1	U3	Adj. Shunt regulator	LM431CZ	National Semiconductor
4	1	VR1	TVS, 600 W, 200 V	P6KE200	On Semiconductor
5	1	BR1	Bridge, 600 V, 2 A	2KBP06M	General Semiconductor
6	1	D1	600 V, 1 A, UFR	UF4005	General Semiconductor
7	2	D2, 4	Diode, 75 V	1N4148	Any
8	1	D3	100 V, 10 A, Schottky	MBR10100	General Semiconductor
9	1	CX1	X2 capacitor, 220 nF	ECQ-U2A224ML	Panasonic
10	1	C1	68 μ F, 400 V, 105 °C 18 mm x 25 mm	KMX400VB68RM18X25LL	United Chemicon
11	1	C2	Ceramic disk, 4.7 nF, 1 kV	5GAD47	Vishay
12	1	C3	47 μ F, 16 V, 105 °C	KME16VB47RM5X11LL	United Chemicon
13	2	C4, 9	100 nF, 50 V, ceramic	C320C104K1R5CA	Kemet
14	1	C5	1 μ F, 50 V, 105 °C	KME50VB1R0M5X11LL	United Chemicon
15	1	CY1	2.2 nF Y1	440LD22	Cera-Mite
16	2	C6, 7	560 μ F, 35 V 10 mm x 25mm (ESR \leq 45 m Ω)	LXZ35VB561M10X25LL	United Chemicon
17	1	C8	100 μ F, 35 V	KME35VB101M8X11LL	United Chemicon
18	1	C10	10 μ F, 50 V, 105 °C	KME50VB10RM5X11LL	United Chemicon
19	1	C11	470 pF, 100 V	C315C471K1R5CA	Kemet
20	1	T1	Transformer, EF25	SIL6020, Rev. 6 NL 021 218 11	Hical VOGT
21	1	L1	Balun, 20 mH, 0.8 A	ELF-18N008A	Panasonic
22	1	L2	3.3 μ H, 2.7 A	622LY3R3M	Toko, or equiv.
23	1	F1	Fuse, 3.15 A, 250 VAC Time Delay	372-1315	Wickman
24	1	R1	2 M Ω , 1/2 W, 5%		Any
25	1	R2	8.2 M Ω , 1/2 W, 5%		Any
26	1	R3	68 Ω , 1/2 W, 5%		Any
27	1	R4	12.1 k Ω , 1%, 1/8 W size		Any
28	1	R5	6.8 Ω , 1/8 W, 5%		Any
29	1	R6	1 k Ω , 1/8 W, 5%		Any
30	1	R7	15 k Ω , 1/8 W, 5%		Any
31	1	R8	3.3 k Ω , 1/8 W, 5%		Any
32	1	R9	38.3 k Ω , 1%, 1/8 W size		Any
33	1	R10	10 k Ω , 1%, 1/8 W size		Any
34	1	R11	33 Ω , 1/4 W, 5%		Any
35	2	HS1, HS2	Heatsink, TO-220	581002B02500	Aavid (also Wakefield 634-10ABP)
36	2	HS1, HS2	Screw, 6-32 5/16" Pan Head Philips Zinc		
37	2	HS1, HS2	Washer, 6-32, Zinc		
38	1	J1	Header 0.156" spacing, 3 pos (pull middle pin)	26-48-1031	Molex
39	1	J2	Header 0.156" spacing, 2 pos	26-48-1021	Molex
40	1		EP-34 Printed Circuit Board, Rev. A		
41	1	JP1-4	Tinned Bus Wire, 22 AWG		



7 Transformer Specification

7.1 Electrical Diagram

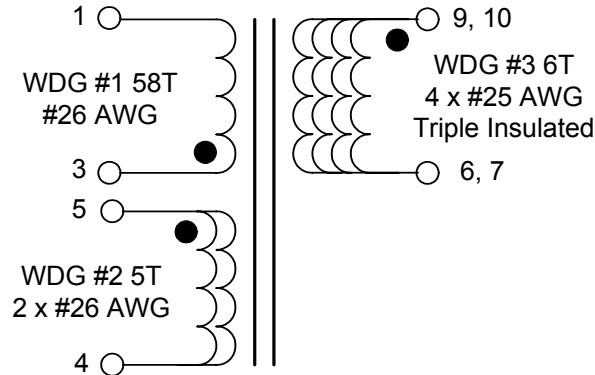

Figure 4 – EP-34 Triple Insulated Transformer.

7.2 Electrical Specifications

Electrical Strength	1 second, 60 Hz, from Pins 1-5 to Pins 6-10	3000 VAC
Primary Inductance	Pins 1-3, all other windings open, measured at 100 kHz, 0.4 VRMS	827 μ H, \pm 10%
Resonant Frequency	Pins 1-3, all other windings open	750 kHz (Min.)
Primary Leakage Inductance	Pins 1-3, with Pins 6-10 shorted, measured at 100 kHz, 0.4 VRMS	20 μ H (Max.)

7.3 Materials

Item	Description
[1]	Core: EF25 Nippon Ceramic NC-2H material or equivalent. Gapped for AL of 246 nH/T ²
[2]	Bobbin: 10 pin EF25, Vertical Mount, Miles-Platts FE0100 with TBS-601 pins or equivalent
[3]	Magnet Wire: #26 AWG Double Coated
[4]	Triple Insulated Wire: #25 AWG
[5]	Tape, 3M #44 or equivalent 1.5 mm wide (min.)
[6]	Tape, 3M #1298 or equivalent 14.2 mm wide
[7]	Tape, 3M #1298 or equivalent 15.7 mm wide
[8]	Varnish

7.4 Transformer Build Diagram

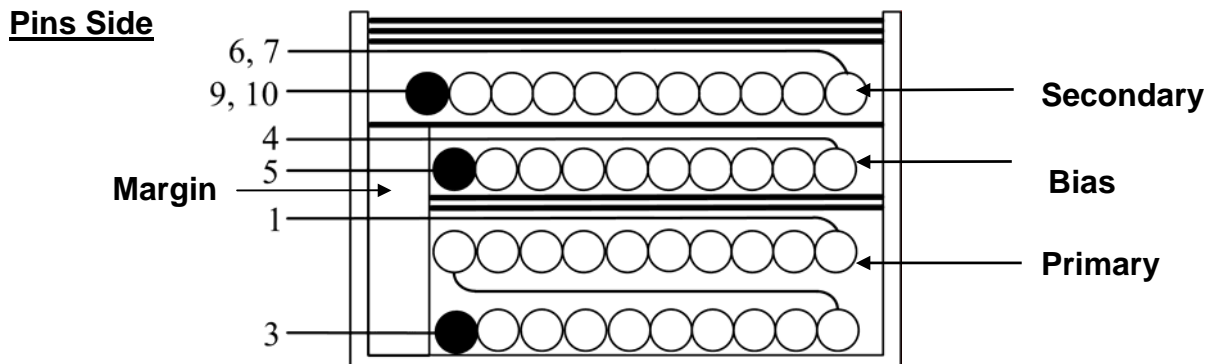

Figure 5 – EP-34 Transformer Build Diagram.

7.5 Transformer Construction

Bobbin Preparation	Pull Pin 8 on bobbin [2] to provide polarization. Bobbin pinout is shown below.
Primary Margin	Apply 1.5 mm wide margin to pin side of bobbin using item [5]. Match height of primary and bias windings. Margin tape is needed to meet safety spacing from primary winding to core and core to secondary pins.
Primary	Start at Pin 3. Wind 30 turns of item [3] in approximately 1 layer. Bring finish lead back to start. Wind remaining 28 primary turns, finish on Pin 1. Note: This “Z” winding technique significantly lowers primary capacitance to reduce no-load power consumption.
Basic Insulation	Use two layers of item [6] for basic insulation.
Bifilar Bias Winding	Starting at Pin 5, wind 5 bifilar turns of item [3]. Spread turns evenly across bobbin. Finish at Pin 4.
Basic Insulation	Use one layer of item [7] for basic insulation.
12 V Quadrifilar Secondary Winding	Start at Pins 9 and 10. Wind 6 quadrifilar turns of item [4] (about 1.2 layers). Spread turns evenly across bobbin. Finish on Pins 6 and 7.
Outer Wrap	Wrap windings with 3 layers of tape [item [7]].
Core Preparation	Wrap bottom of one E core [1] with 2 layers of tape [7] as shown.
Final Assembly	Assemble and secure core halves so that the tape wrapped E core is at the bottom of the transformer. Varnish impregnate (item [8]).

7.6 Transformer Sources

For information on the vendors used to source the transformers used on this board, please visit the *Power Integrations'* Web site at the URL below and select “Engineering Prototype Boards”.

<http://www.powerint.com/componentsuppliers.htm>

8 Transformer Spreadsheets

Power Supply Input

VACMIN	Volts	85			Min Input AC Voltage
VACMAX	Volts	265			Max Input AC Voltage
FL	Hertz	50			AC Main Frequency
TC	mSeconds	2.21			Bridge Rectifier Conduction Time Estimate
Z		0.49			Loss Allocation Factor
N	%	80.0			Efficiency Estimate

Power Supply Outputs

VOx	Volts		12.00	9.00	Output Voltage
IOx	Amps		2.500	0.010	Output Current
VB	Volts	15.00			Bias Voltage
IB	Amps	0.006			Bias Current

Device Variables

Device		TOP245Y/F			Device Name
PO	Watts	30.18			Total Output Power
VDRAIN	Volts	647			Maximum Drain Voltage Estimate (Includes Effect of Leakage Inductance)
VDS	Volts	5.2			Device On-State Drain to Source Voltage
FS	Hertz	132000			Device Switching Frequency
KRPKDP		0.40			Ripple to Peak Current Ratio
KI		0.70			External Current Limit Ratio
ILIMITEXT	Amps	1.17			Device Current Limit External Minimum
ILIMITMIN	Amps	1.67			Device Current Limit Minimum
ILIMITMAX	Amps	1.93			Device Current Limit Maximum
IP	Amps	0.98			Peak Primary Current
IRMS	Amps	0.63			Primary RMS Current
DMAX		0.63			Maximum Duty Cycle

Power Supply Components Selection

CIN	uFarads	68.0			Input Filter Capacitor
VMIN	Volts	76			Minimum DC Input Voltage
VMAX	Volts	375			Maximum DC Input Voltage
VCLO	Volts	190			Clamp Zener Voltage
PZ	Watts	2.5			Estimated Primary Zener Clamp Loss
VDB	Volts	0.7			Bias Winding Diode Forward Voltage Drop
PIVB	Volts	64			Bias Rectifier Maximum Peak Inverse Voltage

Power Supply Output Parameters

VDx	Volts		0.5	0.5	Output Winding Diode Forward Voltage Drop
PIVSx	Volts		51	39	Output Rectifier Maximum Peak Inverse Voltage
ISPx	Amps		9.17	0.04	Peak Secondary Current
ISRMSx	Amps		4.52	0.02	Secondary RMS Current
IRIPPLEx	Amps		3.77	0.02	Output Capacitor RMS Ripple Current

Transformer Construction Parameters

Core/Bobbin		E25/13/7 (EF25) Margi		Core and Bobbin Type
Core Manuf.		Generic		Core Manufacturing
Bobbin Manuf		Generic		Bobbin Manufacturing
LP	uHenries	827		Primary Inductance
NP		58		Primary Winding Number of Turns
NB		7.54		Bias Winding Number of Turns
AWG	AWG	27		Primary Wire Gauge (Rounded to next smaller standard AWG value)
CMA	Cmils/A	322		Primary Winding Current Capacity
VOR	Volts	120.00		Reflected Output Voltage
BW	mm	15.30		Bobbin Physical Winding Width
M	mm	1.0		Safety Margin Width
L		2.0		Number of Primary Layers
AE	cm ²	0.53		Core Effective Cross Section Area
ALG	nH/T ²	249		Gapped Core Effective Inductance
BM	Gauss	2693		Maximum Operating Flux Density
BP	Gauss	3688		Peak Flux Density
BAC	Gauss	539		AC Flux Density for Core Curves
LG	mm	0.23		Gap Length
LL	uHenries	12.4		Estimated Transformer Primary Leakage Inductance
LSEC	nHenries	20		Estimated Secondary Trace Inductance

Secondary Parameters

NSx			6.00	4.56	Secondary Number of Turns
Rounded Down NSx				4	Rounded to Integer Secondary Number of Turns
Rounded Down Vox	Volts			7.83	Auxiliary Output Voltage for Rounded to Integer NSx
Rounded Up NSx				5	Rounded to Next Integer Secondary Number of Turns
Rounded Up Vox	Volts			9.92	Auxiliary Output Voltage for Rounded to Next Integer NSx
AWGSx Range	AWG		17 - 21	40 - 44	Secondary Wire Gauge Range Comment: Primary wire gauge is less than recommended minimum (26 AWG) and may overheat Tip: Consider a parallel winding technique (bifilar, trifilar), increase size of transformer (larger BW) or reduce margin (M). Comment: Wire

9 Performance Data

All measurements performed at room temperature, 60 Hz input frequency.

9.1 Efficiency

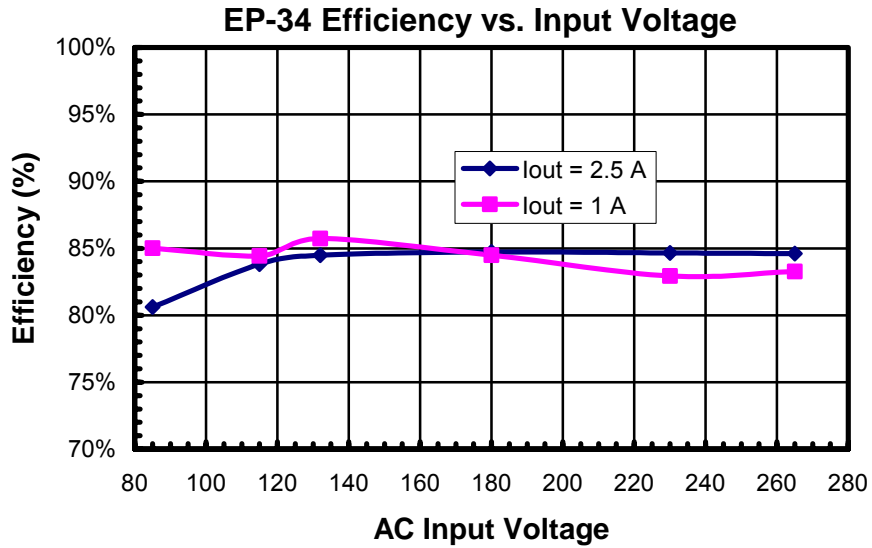

Figure 6 - Efficiency vs. Input Voltage, Room Temperature, 60 Hz.

9.2 No-load Input Power

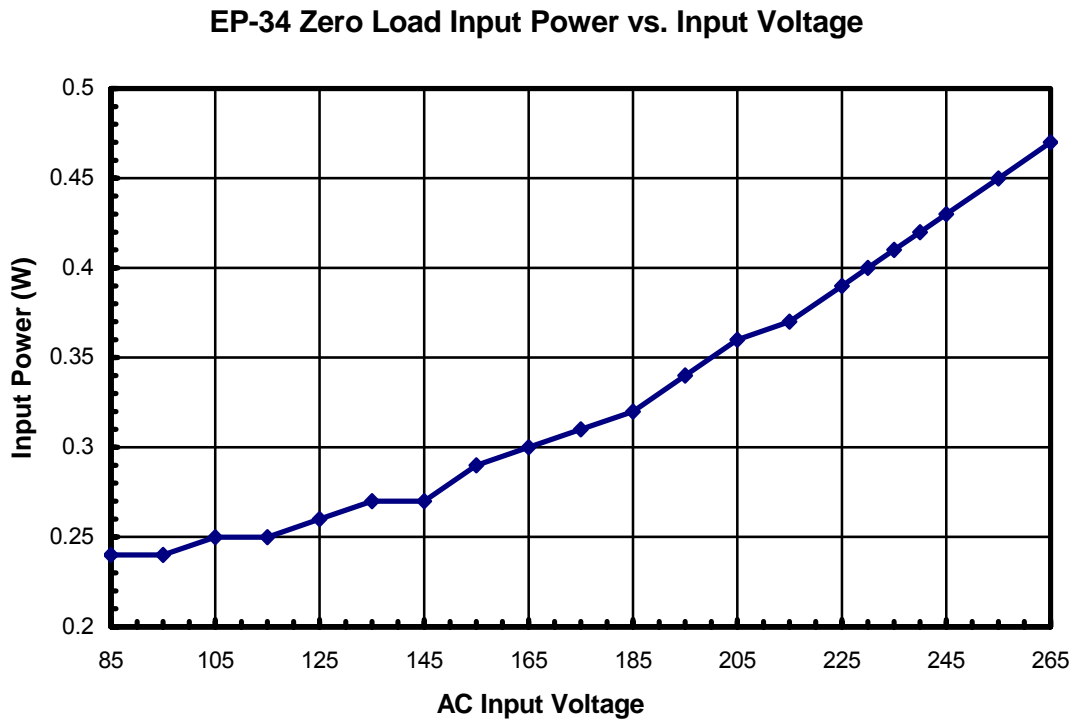

Figure 7 - Zero Load Input Power vs. Input Line Voltage, Room Temperature, 60 Hz.

9.3 Regulation

9.3.1 Load

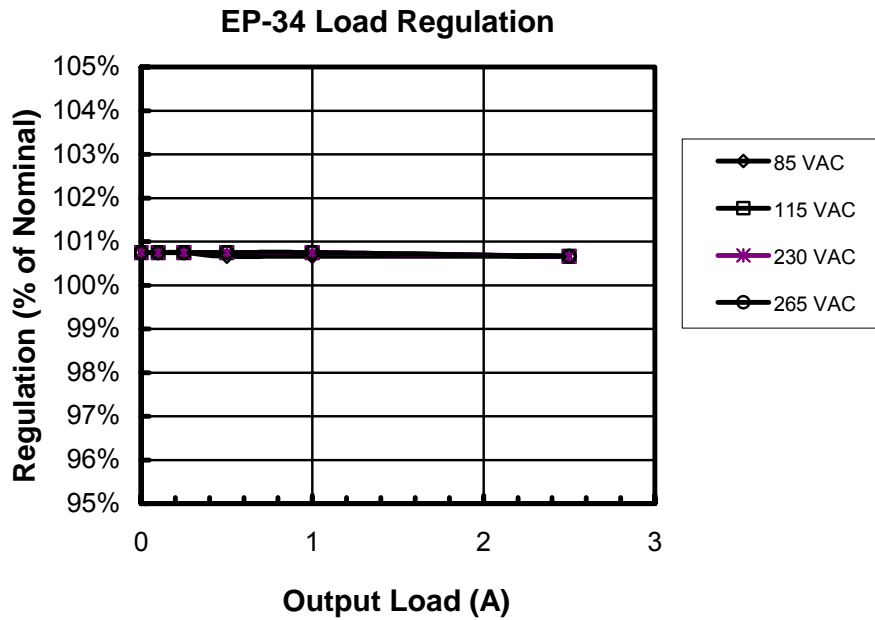

Figure 8 – EP-34 Load Regulation, Room Temperature.

9.3.2 Line

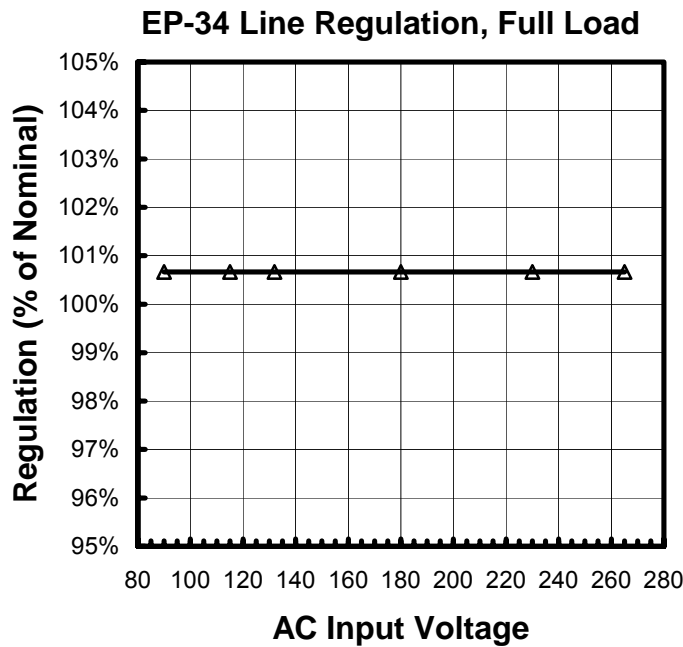

Figure 9 – EP-34 Line Regulation, Room Temperature, Full Load.

9.4 Overload Power

The curve below shows the maximum overload power vs. input line voltage. The X pin of U1 is used to reduce the primary current limit with increasing line voltage, limiting overload power.

Overload Power vs Line Voltage

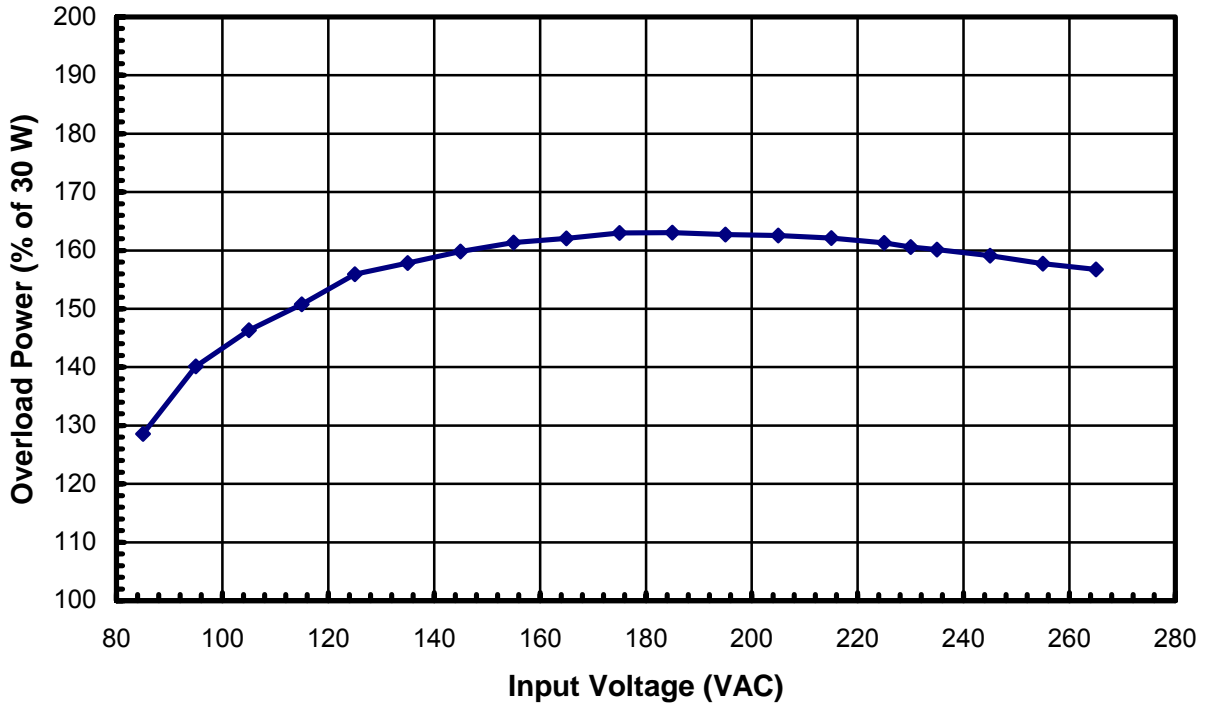

Figure 10 – EP-34 Overload Power vs. Line Voltage, Room Temperature.

10 Thermal Performance

All measurements were made with the unit operating open frame in still air with a load of 30 W. The results show adequate thermal margin, the worst case being low line and 50 °C ambient.

Note: The thermal image does not correctly indicate the temperature of the capacitors due to their shiny top surface.

Temperature (°C)						
Item	85 VAC	115 VAC	230 VAC	85 VAC	115 VAC	230 VAC
Ambient	29	28	28	50	50	52
Balun (L1)	54	43	36	82	74	66
Bridge (BR1)	63	49	43	92	83	73
Transformer (T1)	62	59	65	89	87	90
Clamp Zener (VR1)	55	55	48	97	89	85
TOPSwitch (U1)	68	57	55	106	91	86
Rectifier (D3)	57	56	55	88	85	85

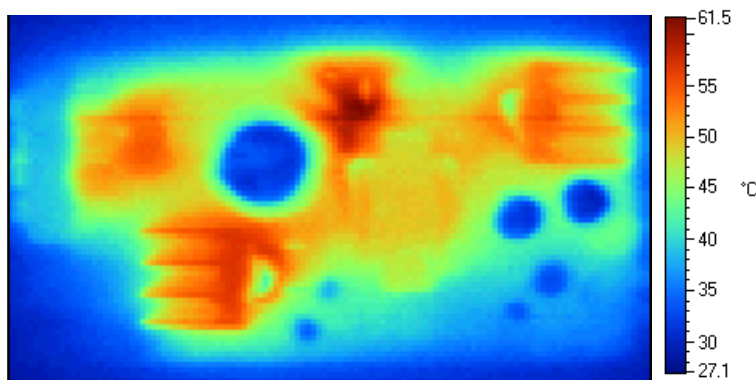

Figure 11 - Infrared Thermograph of EP-34, 85 VAC Input, Maximum Continuous Load, 22 °C Ambient.

11 Waveforms

11.1 Drain Voltage and Current, Normal Operation

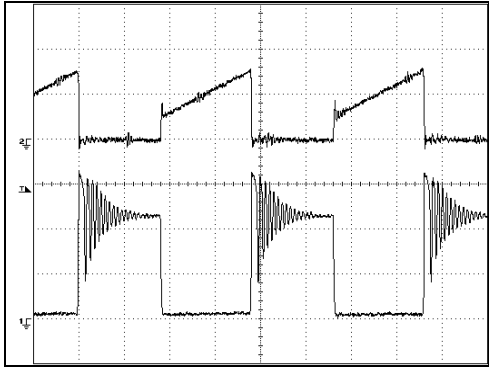

Figure 12 - 85 VAC, Full Load.
 Upper: I_{DRAIN} , 0.5 A/div.
 Lower: V_{DRAIN} , 100 V, 2 μ s/div.

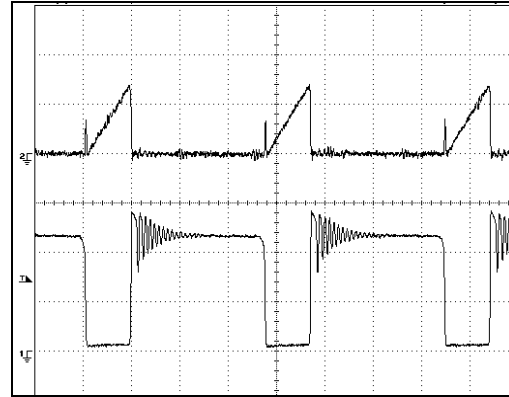

Figure 13 - 265 VAC, Full Load.
 Upper: I_{DRAIN} , 0.5 A /div.
 Lower: V_{DRAIN} , 200 V, 2 μ s/div.

11.2 Output Voltage Start-up Profile

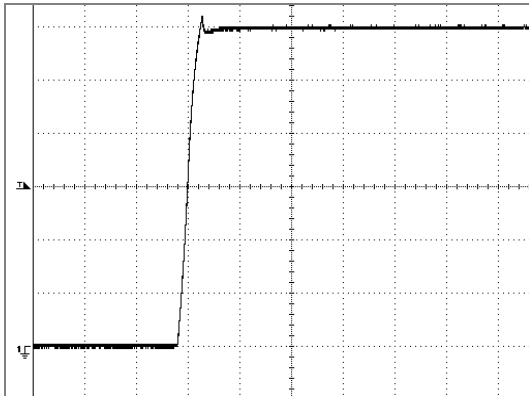

Figure 14 - Start-up Profile, 115 VAC.
 2 V, 20 ms/div.

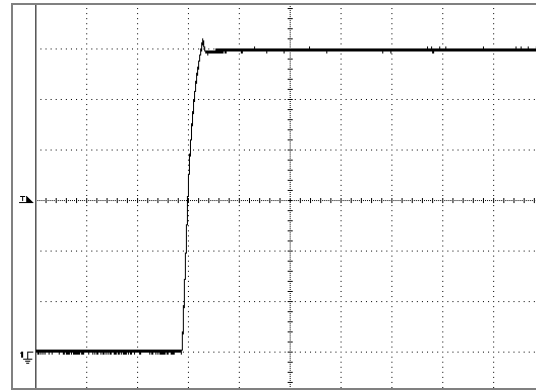

Figure 15 - Start-up Profile, 230 VAC.
 2 V, 20 ms/div.

11.3 Drain Voltage and Current Start-up Profile

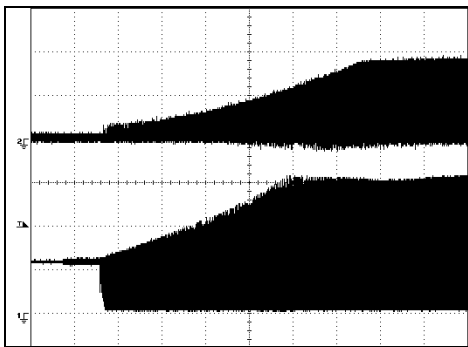

Figure 16 - 85 VAC Input and Maximum Load.
 Upper: I_{DRAIN} , 0.5 A/div.
 Lower: V_{DRAIN} , 100 V, 1 ms/div.

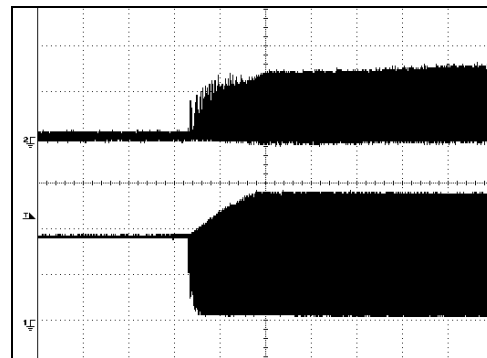

Figure 17 - 265 VAC Input and Maximum Load.
 Upper: I_{DRAIN} , 0.5 A /div.
 Lower: V_{DRAIN} , 200 V, 1 ms/div.



11.4 Load Transient Response (75% to 100% Load Step)

In the figures shown below, signal averaging was used to better enable viewing the load transient response. The oscilloscope was triggered using the load current step as a trigger source. Since the output switching and line frequency occur essentially at random with respect to the load transient, contributions to the output ripple from these sources will average out, leaving the contribution only from the load-step response.

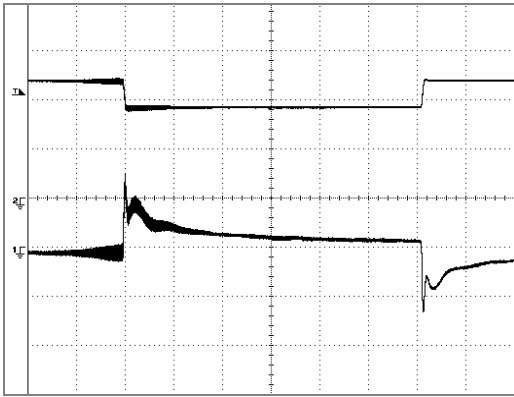

Figure 18 – EP-34 Transient Response, 115 VAC,
75%-100%-75% Load Step.
Top: Load Current, 1 A/div.
Bottom: Output Voltage.
50 mV, 500 μ s/div.

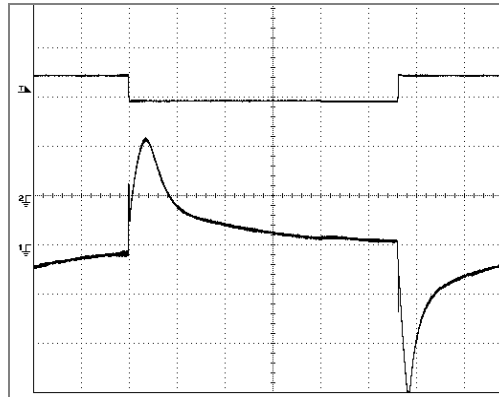

Figure 19 – EP-34 Transient Response, 230 VAC,
75%-100%-75% Load Step
Upper: Load Current, 1 A/div.
Bottom: Output Voltage.
50 mV, 2 ms/div.

11.5 Output Ripple Measurements

11.5.1 Ripple Measurement Technique

For DC output ripple measurements, a modified oscilloscope test probe must be utilized in order to reduce spurious signals due to pickup. Details of the probe modification are provided in Figure 19 and Figure 20.

The 5125BA probe adapter is affixed with two capacitors tied in parallel across the probe tip. The capacitors include one (1) 0.1 $\mu\text{F}/50\text{ V}$ ceramic type and one (1) 1.0 $\mu\text{F}/50\text{ V}$ aluminum electrolytic. **The aluminum electrolytic type capacitor is polarized, so proper polarity across DC outputs must be maintained (see below).**

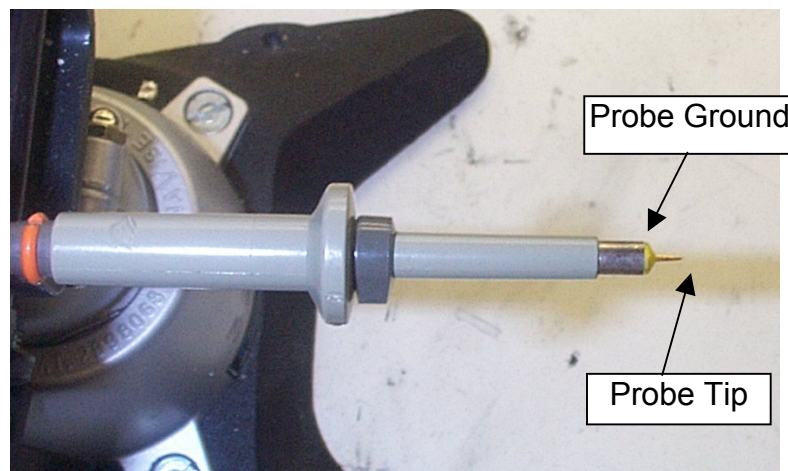

Figure 20 - Oscilloscope Probe Prepared for Ripple Measurement (End Cap and Ground Lead Removed).



Figure 21 - Oscilloscope Probe with Probe Master 5125BA BNC Adapter (Modified with wires for probe ground for ripple measurement, and two parallel decoupling capacitors added).

11.5.2 Measurement Results

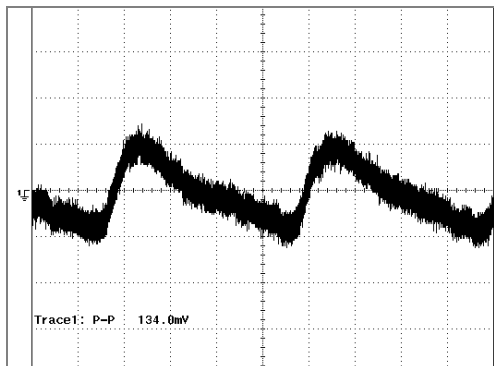

Figure 22 - Ripple, 85 VAC, Full Load.
2 ms, 50 mV / div.

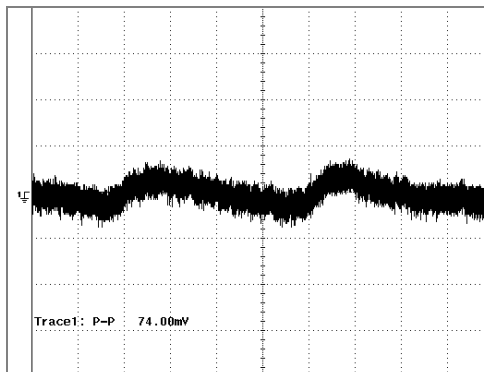

Figure 23 - 5 V Ripple, 115 VAC, Full Load.
2 ms, 50 mV / div.

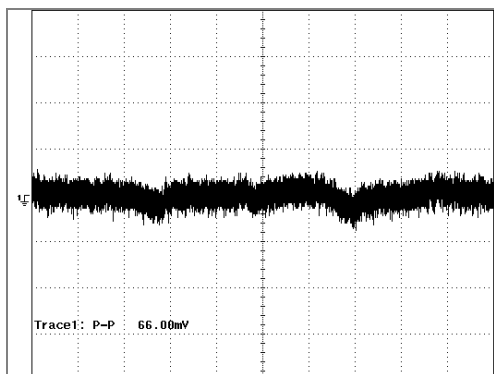

Figure 24 - Ripple, 230 VAC, Full Load.
2 ms, 50 mV /div.

12 Control Loop Measurements

12.1 115 VAC Maximum Load

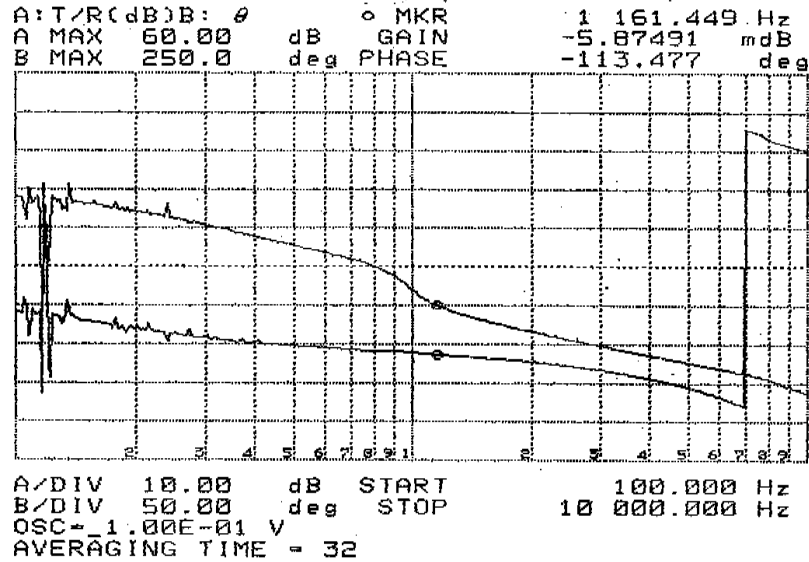

Figure 25 - Gain-Phase Plot, 180 VAC, Maximum Steady State Load.
Vertical Scale: Gain = 10 dB/div, Phase = 50°/div.
Crossover Frequency = 1.16 kHz Phase Margin = 66.5°

12.2 230 VAC Maximum Load

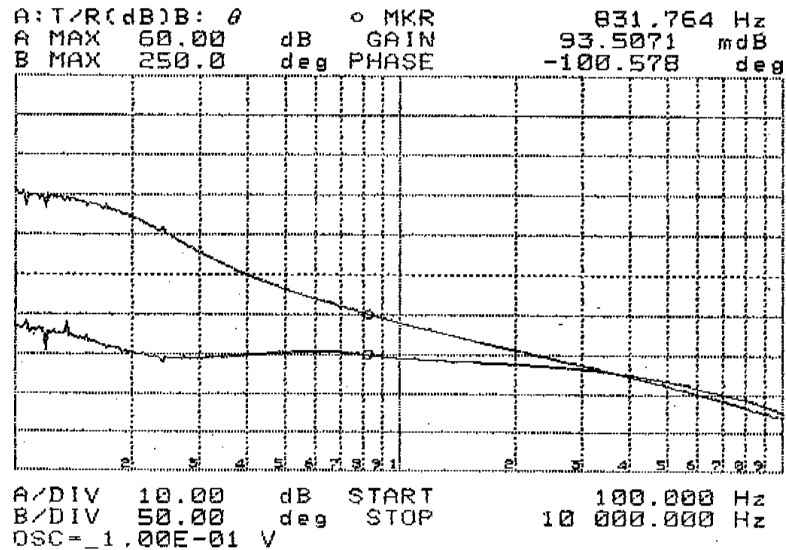

Figure 26 - Gain-Phase Plot, 230 VAC, Maximum Steady State Load.
Vertical Scale: Gain = 10 dB/div, Phase = 50°/div.
Crossover Frequency = 831 Hz, Phase Margin = 79.4°

13 Conducted EMI

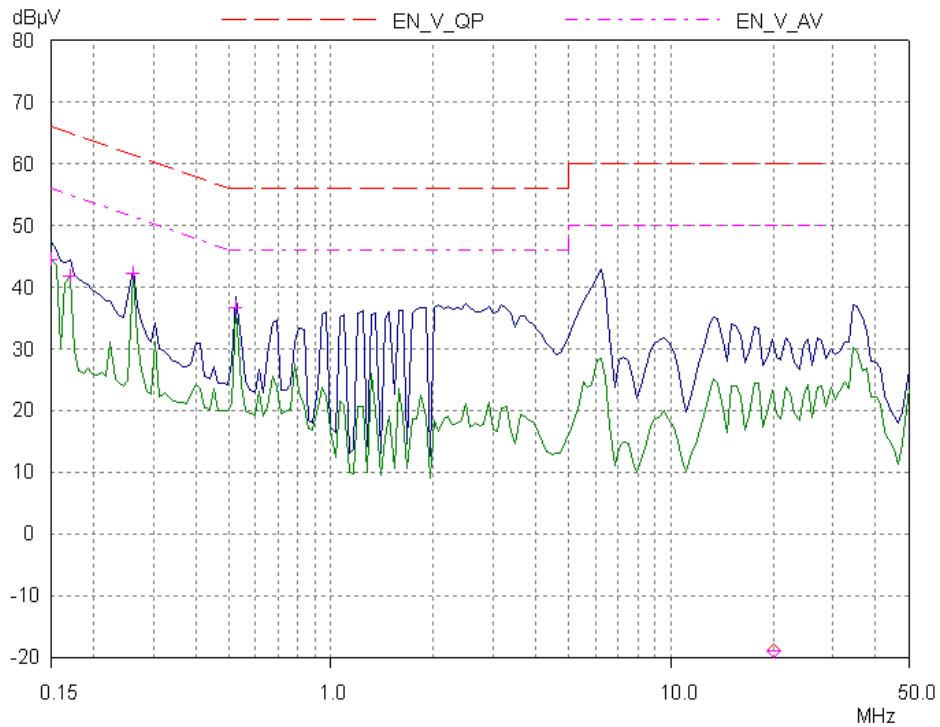

Figure 26 - Conducted EMI, Maximum Steady State Load, 115 VAC, 60 Hz, and EN55022 B Limits.

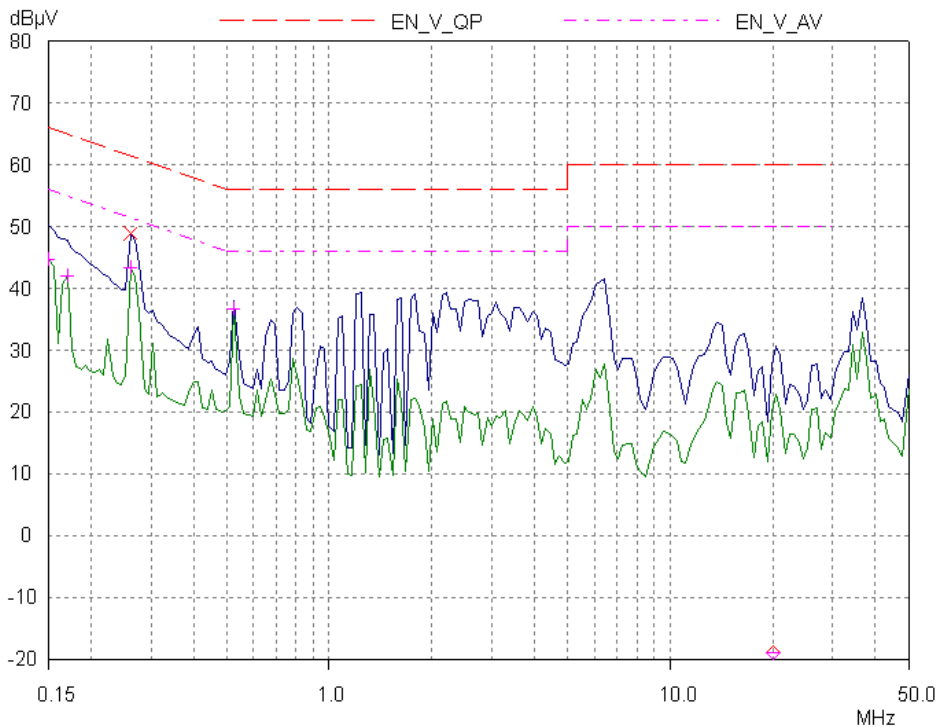

Figure 27 - Conducted EMI, Maximum Steady State Load, 230 VAC, 60 Hz, and EN55022 B Limits.

14 AC Surge and 100 kHz Ring Wave Immunity

Four series of line transient tests were performed on the EP-34 to determine the level of immunity attainable for the basic board. Testing was performed using a Keytek EMC Pro surge generator. The input voltage for the supply under test was 230 VAC, and the supply was loaded to the maximum continuous output power using a resistive load. An LED was used to monitor the presence of output voltage and to detect output interruptions. The secondary return was hard wired to the safety ground at the surge generator. This is a worst-case test condition for common mode surge and ring wave testing, and the test results reflect this. If surge tests are conducted without this ground connection, the common mode surge/ring wave withstand is higher. Test for each series was terminated upon non-destructive interruption of output voltage, arcing, or non-recoverable interruption of output voltage. A test failure was defined as a non-recoverable interruption of output voltage requiring supply repair or recycling of input AC voltage.

14.1 Common Mode Surge, 1.2/50 μ s

Surge Voltage	Phase Angle (°)	Generator Impedance	Number of Strikes	Test Result
1 kV	0	12 Ω	10	PASS
1 kV	90	12 Ω	10	PASS
1 kV	270	12 Ω	10	PASS
2 kV	0	12 Ω	10	PASS
2 kV	90	12 Ω	10	PASS
2 kV	270	12 Ω	10	PASS
3 kV	0	12 Ω	10	PASS
3 kV	90	12 Ω	10	PASS
3 kV	270	12 Ω	10	PASS
4 kV	0	12 Ω	10	PASS (1 power interruption/10strikes, recovered)
4 kV	90	12 Ω	10	PASS (2 power interruptions/10 strikes, recovered)
4 kV	270	12 Ω	1	PASS (4 power interruptions/10 strikes, recovered)

14.2 Differential Mode Surge, 1.2/50 μ s

Surge Voltage	Phase Angle (°)	Generator Impedance	Number of Strikes	Test Result
1 kV	0	12 Ω	10	PASS
1 kV	90	12 Ω	10	PASS
1 kV	270	12 Ω	10	PASS
2 kV	0	12 Ω	10	PASS
2 kV	90	12 Ω	10	PASS
2 kV	270	12 Ω	10	PASS
3 kV	0	12 Ω	10	PASS
3 kV	90	12 Ω	10	PASS
3 kV	270	12 Ω	10	PASS
4kV	0	12 Ω	10	PASS
4 kV	90	12 Ω	10	PASS
4 kV	270	12 Ω	10	PASS

14.3 Common Mode, 100 kHz Ring Wave

Surge Voltage (kV)	Phase Angle (°)	Short Circuit Current	Number of Strikes	Test Result
1 kV	0	500 A	10	PASS
1 kV	90	500 A	10	PASS
1 kV	270	500 A	10	PASS
2 kV	0	500 A	10	PASS
2 kV	90	500 A	10	PASS
2 kV	270	500 A	10	PASS
3 kV	0	500 A	10	PASS (6 interruptions/10 strikes, recovered)
3 kV	90	500 A	10	PASS (7 interruptions/10 strikes, recovered)
3 kV	270	500 A	10	PASS (6 interruptions/10 strikes, recovered)

14.4 Differential Mode, 100 kHz Ring Wave

Surge Voltage	Phase Angle (°)	Short Circuit Current	Number of Strikes	Test Result
1 kV	0	500 A	10	PASS
1 kV	90	500 A	10	PASS
2 kV	270	500 A	10	PASS
2 kV	0	500 A	10	PASS
2 kV	90	500 A	10	PASS
3 kV	270	500 A	10	PASS
3 kV	0	500 A	10	PASS
3 kV	90	500 A	10	PASS
3 kV	270	500 A	10	PASS
4 kV	0	500 A	10	PASS
4 kV	90	500 A	10	PASS
4 kV	270	500 A	10	PASS

15 Revision History

Date	Author	Revision	Description & changes
28-Jan-03	RH	0.1	First draft
03-Feb-03	RH	0.2	Second draft
21-Feb-03	RH	0.3	Third draft
21-Apr-03	RH	1.0	First Release
10-Feb-04	KM	1.1	Second Release – Transformer specification on page 11 corrected (primary inductance, resonant frequency and ALG).

For the latest updates, visit our Web site: www.powerint.com

Power Integrations may make changes to its products at any time. Power Integrations has no liability arising from your use of any information, device or circuit described herein nor does it convey any license under its patent rights or the rights of others. POWER INTEGRATIONS MAKES NO WARRANTIES HEREIN AND SPECIFICALLY DISCLAIMS ALL WARRANTIES INCLUDING, WITHOUT LIMITATION, THE IMPLIED WARRANTIES OF MERCHANTABILITY, FITNESS FOR A PARTICULAR PURPOSE, AND NON-INFRINGEMENT OF THIRD PARTY RIGHTS.

PATENT INFORMATION

The products and applications illustrated herein (including circuits external to the products and transformer construction) may be covered by one or more U.S. and foreign patents or potentially by pending U.S. and foreign patent applications assigned to Power Integrations. A complete list of Power Integrations' patents may be found at www.powerint.com.

The PI Logo, *TOPSwitch*, *TinySwitch*, *LinkSwitch*, and *EcoSmart* are registered trademarks of Power Integrations. *PI Expert* and *DPA-Switch* are trademarks of Power Integrations.
© Copyright 2004, Power Integrations.

WORLD HEADQUARTERS

Power Integrations
5245 Hellyer Avenue
San Jose, CA 95138, USA.
Main: +1-408-414-9200
Customer Service:
Phone: +1-408-414-9665
Fax: +1-408-414-9765
e-mail:
usasales@powerint.com

AMERICAS

Power Integrations
4335 South Lee Street,
Suite G
Buford, GA 30518, USA
Phone: +1-678-714-6033
Fax: +1-678-714-6012
e-mail:
usasales@powerint.com

CHINA (SHANGHAI)

Power Integrations
International Holdings, Inc.
Rm 807, Pacheer
Commercial Centre
555 Nanjing West Road
Shanghai, 200041, China
Phone: +86-21-6215-5548
Fax: +86-21-6215-2468
e-mail:
chinasales@powerint.com

APPLICATIONS HOTLINE

World Wide +1-408-414-9660

CHINA (SHENZHEN)

Power Integrations
International Holdings, Inc.
Rm# 1705, Bao Hua Bldg.
1016 Hua Qiang Bei Lu
Shenzhen Guangdong,
518031, China
Phone: +86-755-8367-5143
Fax: +86-755-8377-9610
e-mail: chinasales@powerint.com

GERMANY

Power Integrations, GmbH
Rueckertstrasse 3
D-80336, Muenchen, Germany
Phone: +49-89-5527-3910
Fax: +49-89-5527-3920
e-mail: eurossales@powerint.com

INDIA (TECHNICAL SUPPORT)

Innovatech
261/A, Ground Floor
7th Main, 17th Cross,
Sadashivanagar
Bangalore 560080
Phone: +91-80-5113-8020
Telefax: +91-80-5113-8023
e-mail: indiasales@powerint.com

APPLICATIONS FAX

World Wide +1-408-414-9760

ITALY

Power Integrations S.r.l.
Via Vittorio Veneto 12,
Bresso
Milano, 20091, Italy
Phone: +39-028-928-6001
Fax: +39-028-928-6009
e-mail:
eurossales@powerint.com

JAPAN

Power Integrations, K.K.
Keihin-Tatemono 1st Bldg.
12-20 Shin-Yokohama
2-Chome,
Kohoku-ku, Yokohama-shi,
Kanagawa 222-0033, Japan
Phone: +81-45-471-1021
Fax: +81-45-471-3717
e-mail:
japansales@powerint.com

KOREA

Power Integrations
International Holdings, Inc.
8th Floor, DongSung Bldg.
17-8 Yoido-dong,
Youngdeungpo-gu,
Seoul, 150-874, Korea
Phone: +82-2-782-2840
Fax: +82-2-782-4427
e-mail:
koreasales@powerint.com

SINGAPORE (ASIA PACIFIC HEADQUARTERS)

Power Integrations, Singapore
51 Newton Road
#15-08/10 Goldhill Plaza
Singapore, 308900
Phone: +65-6358-2160
Fax: +65-6358-2015
e-mail:
singaporesales@powerint.com

TAIWAN

Power Integrations
International Holdings, Inc.
5F-1, No. 316, Nei Hu Rd., Sec. 1
Nei Hu Dist.
Taipei, Taiwan 114, R.O.C.
Phone: +886-2-2659-4570
Fax: +886-2-2659-4550
e-mail:
taiwansales@powerint.com

UK (EUROPE & AFRICA HEADQUARTERS)

Power Integrations (Europe) Ltd.
1st Floor, St. James's House
East Street
Farnham
Surrey
GU9 7TJ
United Kingdom
Phone: +44 (0) 1252-730-140
Fax: +44 (0) 1252-727-689
e-mail: eurossales@powerint.com