

SBD Type : FCH05A10

OUTLINE DRAWING

5A 100V Tj:150°C
FEATURES

- *TO-220AB Case
- *Fully Molded
- *Dual Diodes – Cathode Common
- *Low Forward Voltage Drop
- *High Surge Capability
- *Tj=150 °C operation

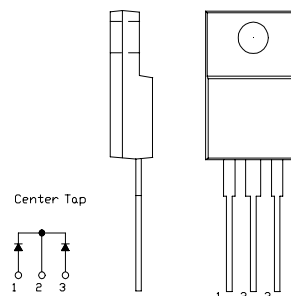

Maximum Ratings

Approx Net Weight: 1.75g

Rating	Symbol	FCH05A10		Unit
Repetitive Peak Reverse Voltage	V_{RRM}	100		V
Average Rectified Output Current	I_O	5	Tc=127°C 50 Hz Full Sine Wave Resistive Load	A
RMS Forward Current	$I_{F(RMS)}$	5.5		A
Surge Forward Current	I_{FSM}	60	50Hz Full Sine Wave ,1cycle Non-repetitive	A
Operating JunctionTemperature Range	T_{jw}	-40 to +150		°C
Storage Temperature Range	T_{stg}	-40 to +150		°C
Mounting torque	Ftor	recommended torque = 0.5		N•m

Electrical • Thermal Characteristics

Characteristics	Symbol	Conditions	Min.	Typ.	Max.	Unit
Peak Reverse Current	I_{RM}	Tj= 25°C, $V_{RM}= V_{RRM}$ per Arm	-	-	1	mA
Peak Forward Voltage	V_{FM}	Tj= 25°C, $I_{FM}= 2.5$ A per Arm	-	-	0.87	V
Thermal Resistance	Rth(j-c)	Junction to Case	-	-	5.0	°C/W
	Rth(c-f)	Cace to Fin	-	-	1.5	°C/W

FCH_A_OUTLINE DRAWING (Dimensions in mm)

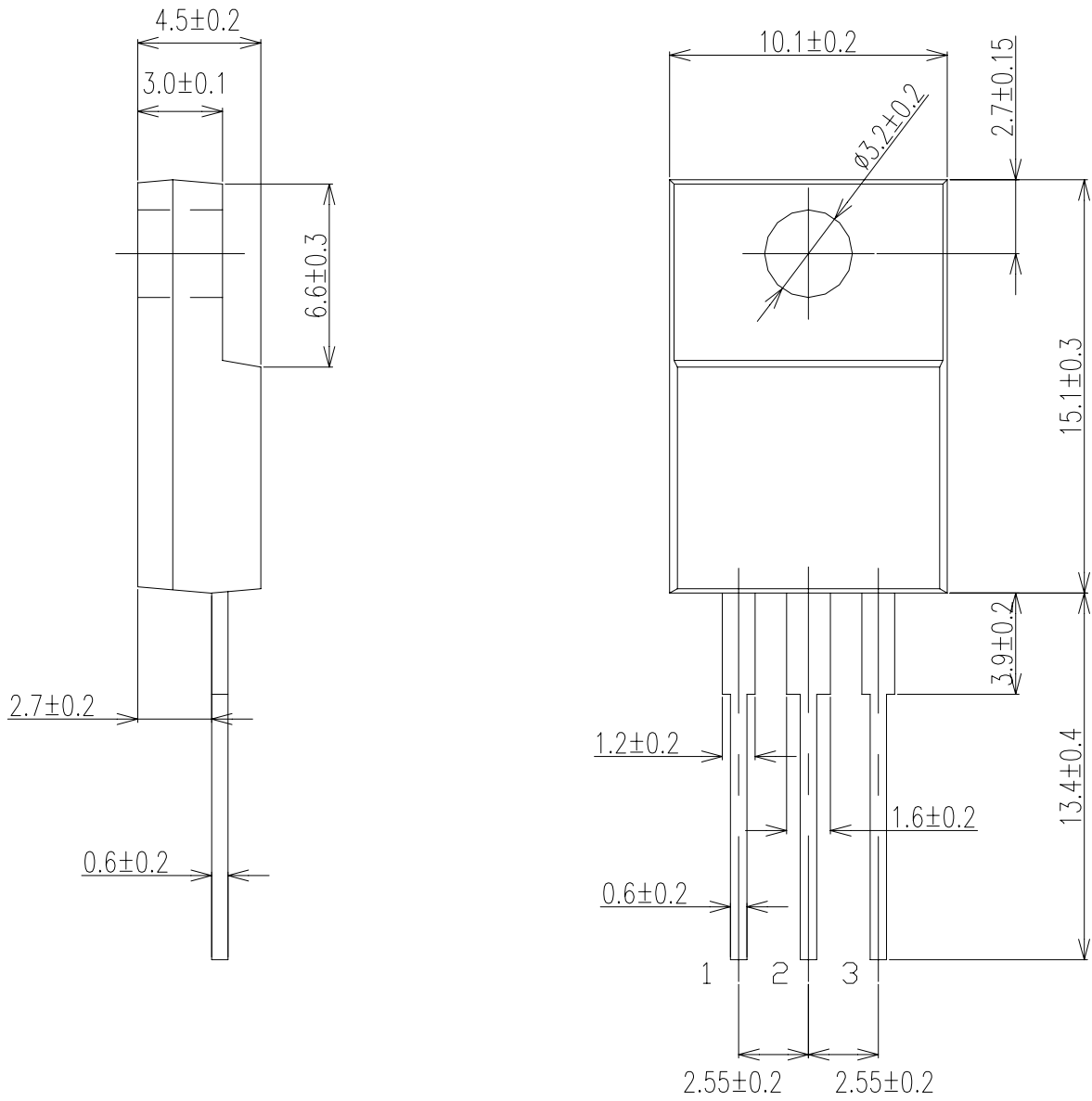

Center Tap

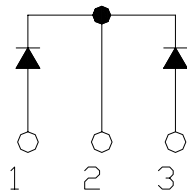

FORWARD CURRENT VS. VOLTAGE

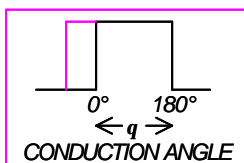
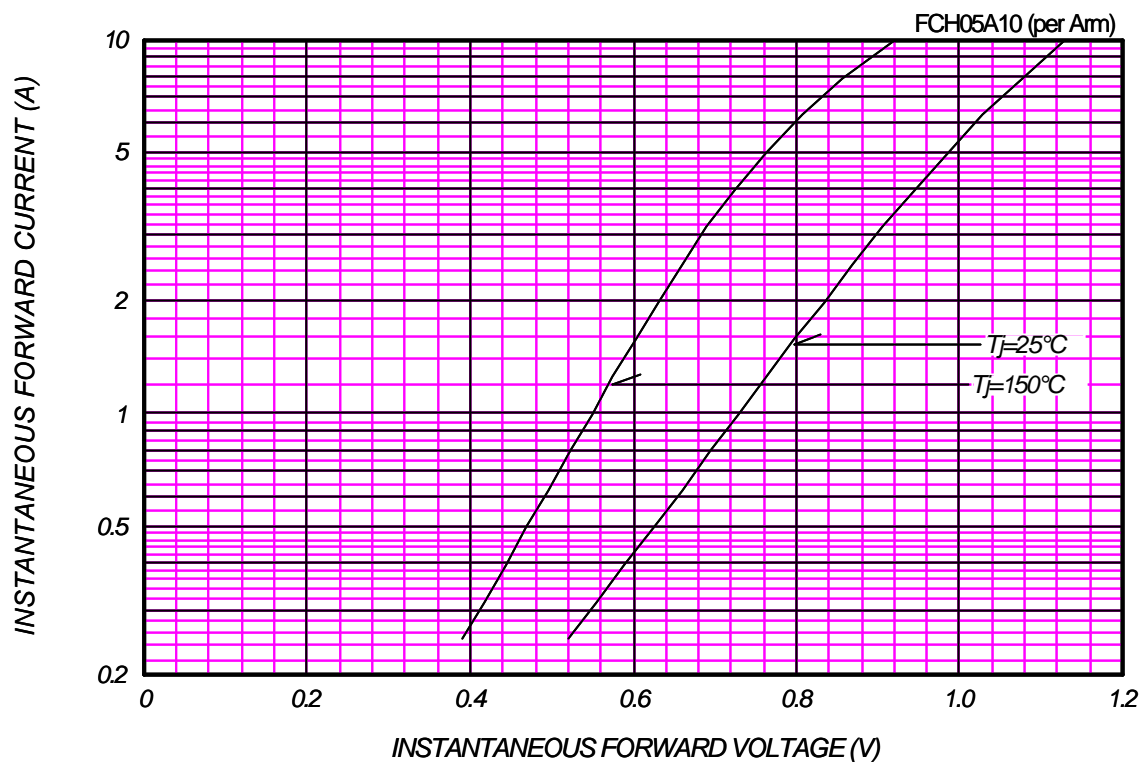

AVERAGE FORWARD POWER DISSIPATION

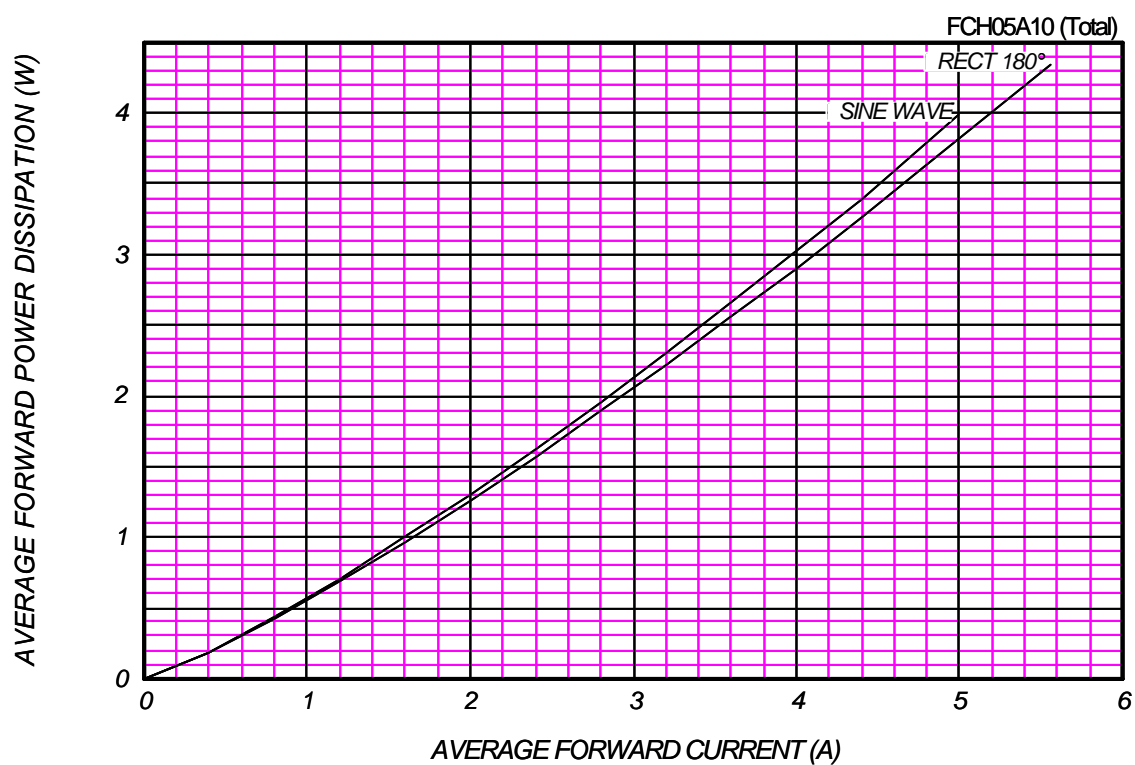

PEAK REVERSE CURRENT VS. PEAK REVERSE VOLTAGE

$T_J = 150^\circ\text{C}$

FCH05A10 (per Arm)

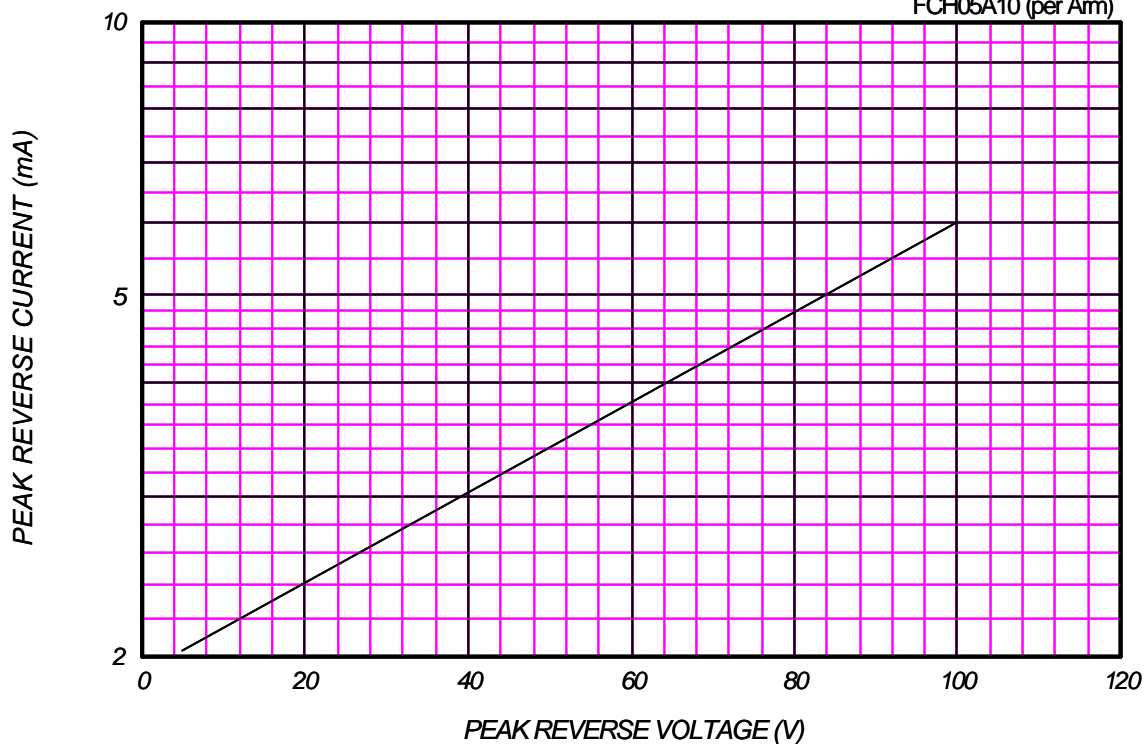

AVERAGE REVERSE POWER DISSIPATION

FCH05A10 (Total)

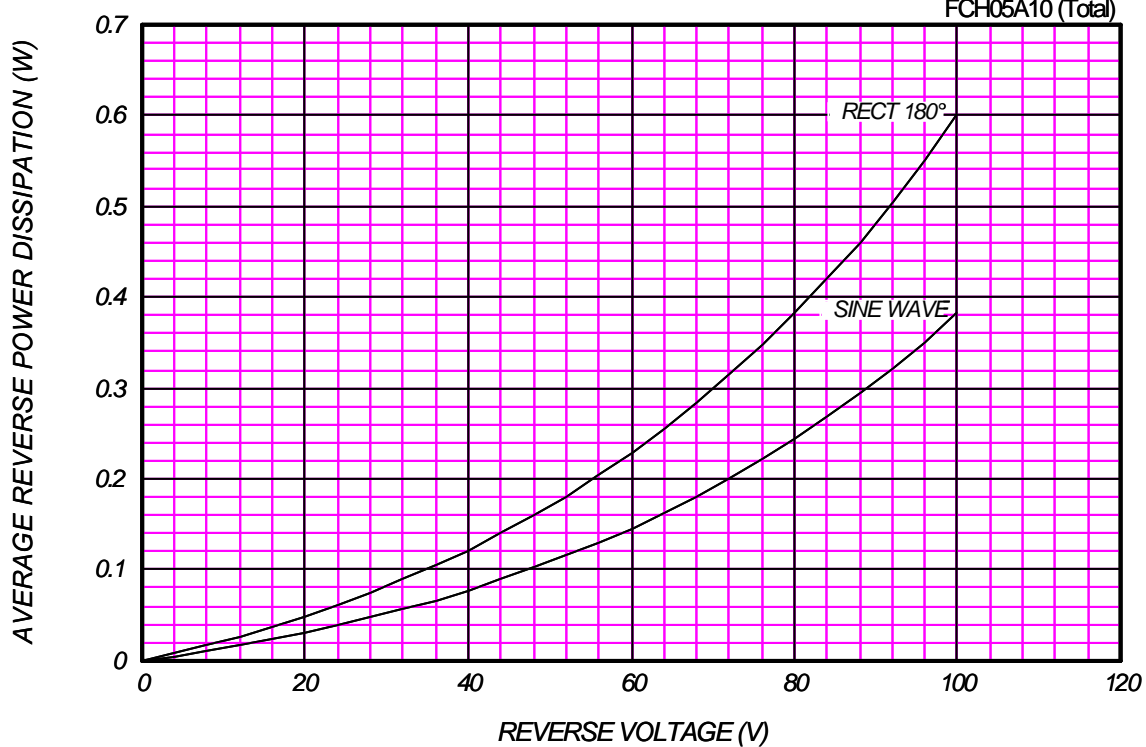

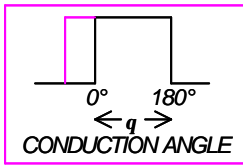

AVERAGE FORWARD CURRENT VS. CASE TEMPERATURE

$V_{RM}=100V$

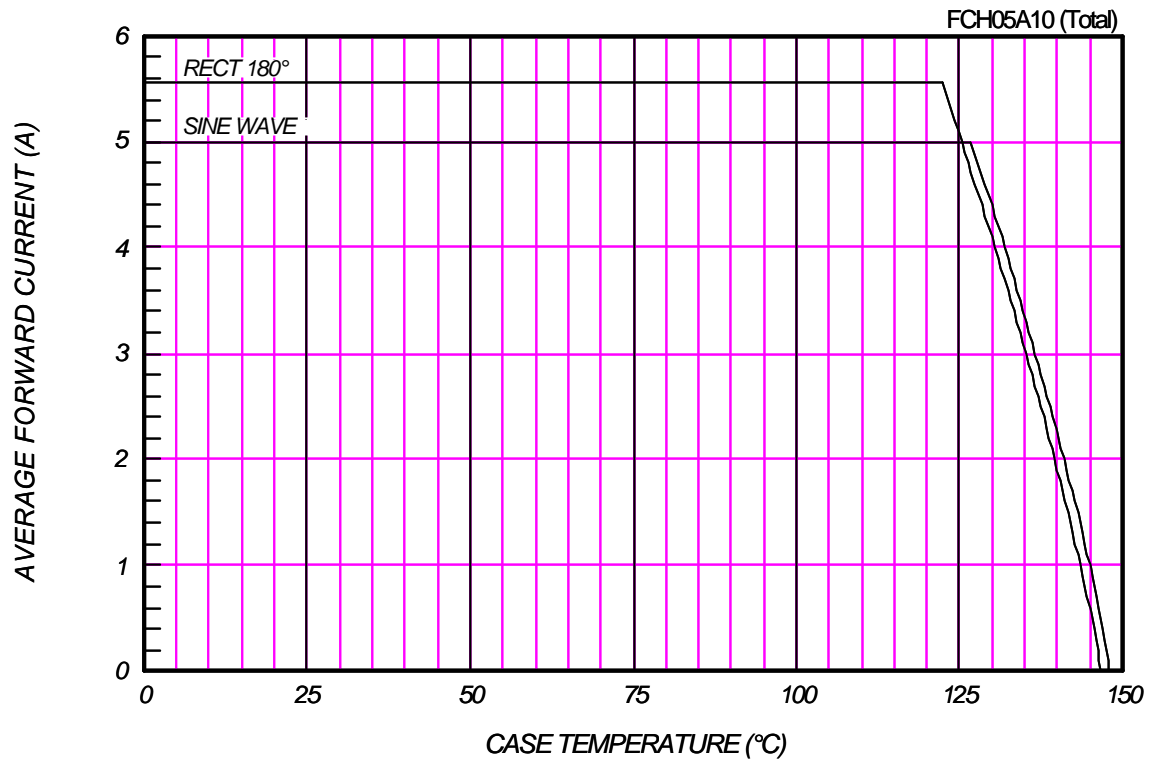

SURGE CURRENT RATINGS

f=50Hz, Sine Wave, Non-Repetitive, No Load

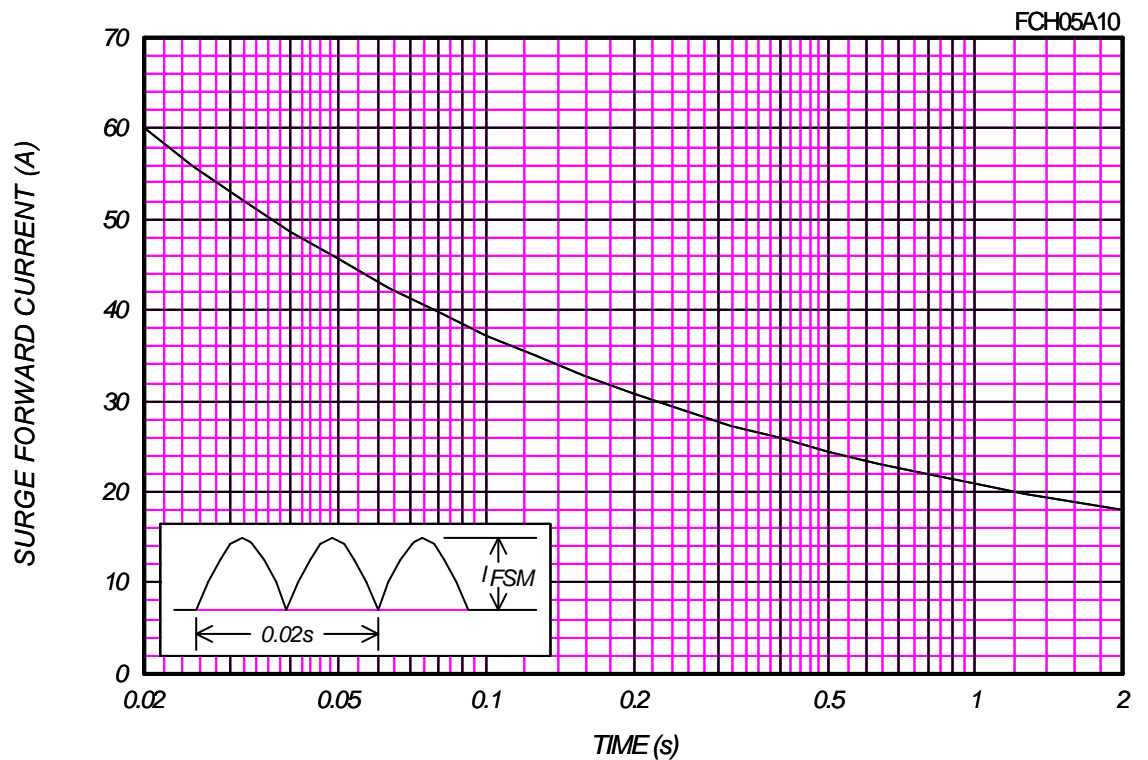

JUNCTION CAPACITANCE VS. REVERSE VOLTAGE

$T_j=25^{\circ}\text{C}$, $V_m=20\text{mV}_{\text{RMS}}$, $f=100\text{kHz}$, Typical Value

FCH05A10 (per Arm)

